

Orientalmotor

Stepper Motors

PKP Series



Stepper Motors













PKP Series

2-Phase

Stepper Motors PKP Series High Torque Low Vibration

● Bipolar (4 lead wires) and unipolar (5 or 6 lead wires) wiring types are available.
(For details on the wiring types, refer to page 10.)

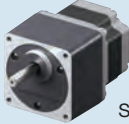
Features / Product Line / System Configuration / How to Read Product Numbers / Product Line / Included Items / Specifications
Table Glossary

Motor Type	Motor Frame Size	Additional Function		
		Standard	With Encoder	With Electromagnetic Brake
Standard Type (Basic Step Angle: 1.8°/step) Flat Connector Reasonable High Strength  Mini-Connector Type  Connector Type  With Encoder  With Electromagnetic Brake Standard	□13 mm	COMING SOON	—	—
	□20 mm	●	●	—
	□28 mm	●	●	●
	□35 mm	●	●	●
	□42 mm	●	●	●
	□56.4 mm	●	●	●
	□60 mm*	●	—	—
	□85 mm	●	—	—
High-Resolution Type (Basic Step Angle: 0.9°/step) Flat Connector Reasonable High Strength  Mini-Connector Type  Connector Type  With Encoder  With Electromagnetic Brake Standard	□28 mm	●	COMING SOON	—
	□42 mm	●	COMING SOON	●
	□56.4 mm	●	COMING SOON	●
Flat Type (Basic Step Angle: 0.018° to 1.8°/step)  Standard  With Harmonic Gears	□42 mm	●	—	—
	□60 mm	●	—	—
	□51 mm	With Harmonic Gears		
	□61 mm	With Harmonic Gears		
SH Geared Type (Basic Step Angle: 0.05° to 0.5°/step)  Standard	□28 mm	●	—	—
	□42 mm	●	—	—
	□60 mm	●	—	—
CS Geared Type (Basic Step Angle: 0.09 to 0.36°/step)  Standard	□28 mm	●	—	—
	□42 mm	●	—	—
	□60 mm	●	—	—

●: 2 types are available—the "Mini-Connector Type" and the "Connector Type" Refer to page 5 for details.

*This is the conventional PK Series.

General Specifications / Electromagnetic Brake Specifications / Encoder Part Specifications / Permissible Radial Load and Permissible Axial Load / Flat Type, Permissible Moment Load with Harmonic Gears / Flat Type, Accuracy with Harmonic Gears / Motor Inner Wiring Diagram and Rotation Direction

P. 102 to 105

COMING SOON

2-Phase PKP Series Standard Type Frame Size 13 mm

- Industry's smallest frame size of 13 mm (as of July 2022, according to a study by Oriental Motor)
- Mass of only 21 g
- Connector types that are easy to work with



Refer to page 19 for details.

5-Phase Stepper Motors PKP Series High Accuracy Low Vibration

Features / Product Line / System Configuration / How to Read Product Numbers / Types and Pricing / Included Items / Specifications Table Glossary

Motor Type	Motor Frame Size	Additional Function		
		Standard	With Encoder	With Electromagnetic Brake
Standard Type (Basic Step Angle: 0.72°/step) Flat Connector Reasonable High Strength Mini-Connector Type Connector Type With Encoder Standard	<input type="checkbox"/> 20 mm*	●	●	—
	<input type="checkbox"/> 28 mm	●	—	—
	<input type="checkbox"/> 42 mm	●	●	—
	<input type="checkbox"/> 56.4 mm	●	●	—
	<input type="checkbox"/> 60 mm	●	●	—
	<input type="checkbox"/> 85 mm*	●	—	—
	<input type="checkbox"/> 60 mm	●	—	—
High-Resolution Type (Basic Step Angle: 0.36°/step) Standard	<input type="checkbox"/> 42 mm	●	—	—
	<input type="checkbox"/> 60 mm	●	—	—

●: 2 types are available—the "Mini-Connector Type" and the "Connector Type" Refer to page 5 for details.

General Specifications / Encoder Part Specifications / Motor Pin Arrangement / Rotation Direction / Permissible Radial Load and Permissible Axial Load

P. 125 to 126

2-Phase 5-Phase Driver for Stepper Motors Compact Low Vibration

Driver Types and Features

Bipolar Driver for 2-Phase Stepper Motors
 Driver for 5-Phase Stepper Motors
CVD Series—Pulse Input Type



Bipolar Driver for 2-Phase Stepper Motors
 Driver for 5-Phase Stepper Motors
CVD Series RS-485 Communication Type

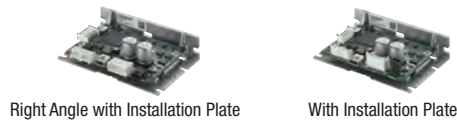

Bipolar Driver for 2-Phase/5-Phase Stepper Motors
CVD Series S Type
 Driver for 5-Phase Stepper Motors
CVD Series SC Type
 Unipolar Driver for 2-Phase Stepper Motors

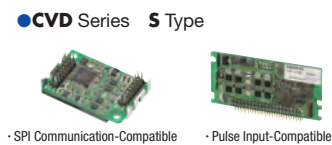

2-Phase Stepper Motors PKP Series

● For detailed information about regulations and standards, please see the Oriental Motor website.

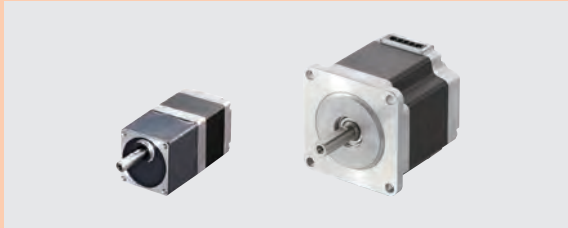

Introducing our Video Library

Videos presenting the features, operations, and methods of use, etc. of the **PKP** Series are available on the Oriental Motor website.

These products are high-torque 2-phase stepper motors. A wide variety of products are available to meet your design specifications.

- Motor Frame Size 13 mm to 85 mm
- Standard Type with a Resolution of 200 Steps per Revolution (Basic step angle: 1.8°/step)
- High-Resolution Type with a Resolution of 400 Steps per Revolution (Basic step angle: 0.9°/step)
- Oriental Motor's Flattest Type of 2-phase Stepper Motor
- High-Torque and High-Resolution **SH** Geared Type
- Bipolar (4 lead wires) and Unipolar (5 or 6 lead wires) are Available
- Encoder Type and Electromagnetic Brake Type are Available
- Many Motor Current Specifications Available

- Motor Frame Size
- 13 mm
 - 20 mm
 - 28 mm
 - 35 mm
 - 42 mm
 - 50 mm
 - 51 mm
 - 56.4 mm
 - 60 mm
 - 61 mm
 - 85 mm
 - 90 mm

Features

Increased Torque over the Entire Speed Range from Low to High

After revising the magnetic design and structure design of the **PKP** Series, it produces much more torque than standard **PK** Series motors of the same size. In addition, torque can be increased in the high-speed range by using high current motors.

Comparison of Speed – Torque Characteristics of the Same Size Motors

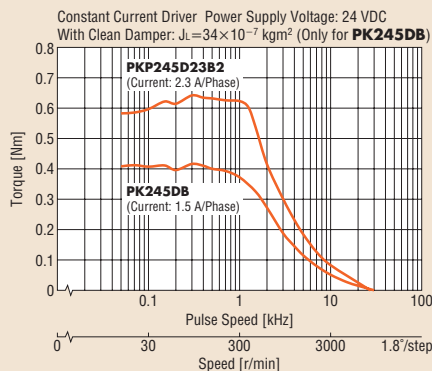

High current is possible due to the revised motor winding design and the highly efficient design of the drive circuit that can be combined. Increased torque over the entire speed range from low to high is achieved.

Comparison of Maximum Holding Torque

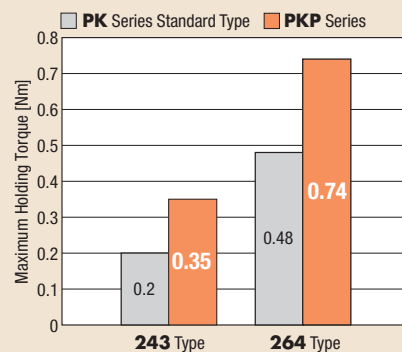

Conservation of Energy and Electrical Power

Reducing the running current supplied to **PKP** Motors achieves the same torque as conventional products while reducing power consumption and CO₂ emissions.

Reduced Running Current with the PKP Series

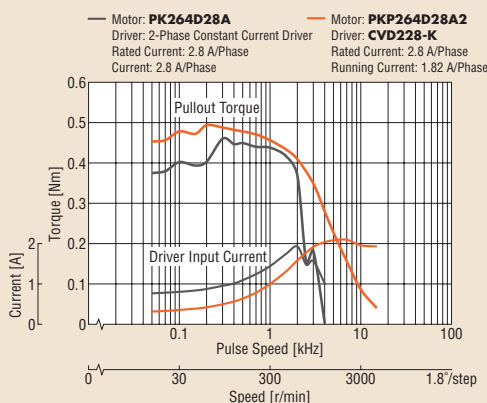

Power Consumption and CO₂ Emissions 56% Lower than Conventional Oriental Motor Products

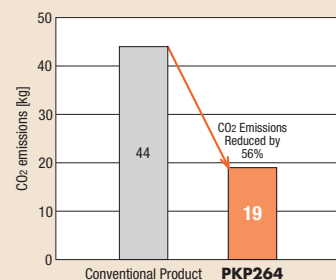

Speed	0.1 kHz (30 r/min)
Operating Time	24 hours, 365 days
Operating Conditions	50% operating, 50% stand-by
Power Supply Voltage	24 VDC
CO ₂ Coefficient	0.519 kg-CO ₂ /kWh

Compact and Flat Connector

The **PKP** Series uses a compact flat connector, which shortens the length of the connector's overhang. In addition, the degree of freedom for the cable outlet direction has been increased, because the outlet direction points upward.

- Because the connector is provided for select products only, refer to the dimensions of each model for details.

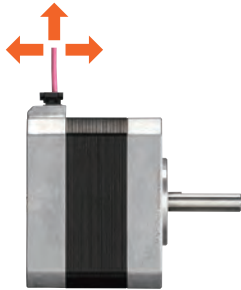

Saving Resources through Downsizing

Use a **PKP** Series motor in place of a standard motor from the **PK** Series with the equivalent torque in order to downsize motors. **Volume reduced by 44%**

Comparison of Torque Characteristics of **PKP244U12A2** and **PK264-02A**

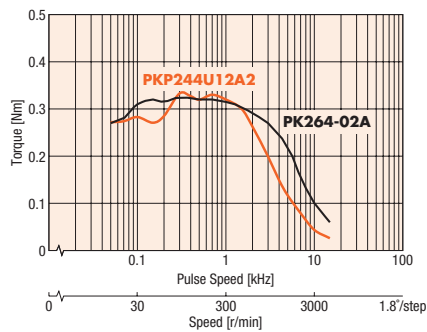

Downsizing is Possible with the Same Torque!

(Unit = mm)

PK264-02A → **PKP244U12A2**

Select Motors by Price, Specifications and Characteristics

The Mini-Connector Type and Connector Type are available in some Standard Type and High-Resolution Type product lines. You can choose according to price and your desired specifications and characteristics.

● Comparison of the Mini-Connector Type and the Connector Type For 2-Phase Stepper Motors

Type	Mini-Connector Type	Connector Type
Prices		Reasonable prices
Features	<ul style="list-style-type: none"> Using a compact flat connector shortens the length of the connector's overhang High permissible radial load/permissible axial load High torque (excluding some types) 	Reasonable prices
Permissible Radial Load (Max. value)	□42 mm: 85 N (63% Increase) □56.4 mm: 270 N (68% Increase)	52 N / 160 N
Permissible Axial Load	□42 mm: 15 N (50% Increase) □56.4 mm: 30 N (50% Increase)	10 N / 20 N

◆ Example of comparison of Torque characteristics with the same size motor (□42 mm bipolar)

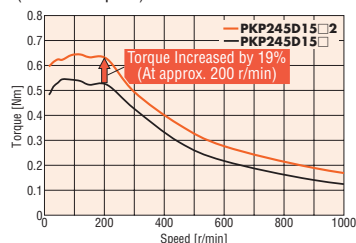

Lower Vibration

Revising the magnetic design has achieved lower vibration than with conventional products.

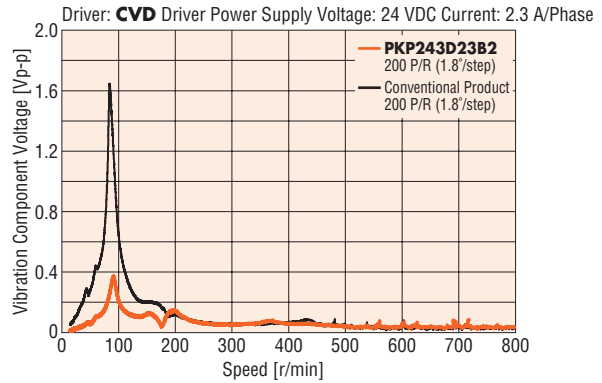

Downsizing is Possible with the Same Torque!

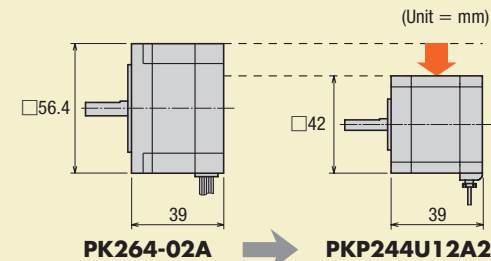

● Permissible Radial Load Increased

By increasing the permissible radial load, the Mini-Connector Type make assembling equipment easier.

◇ Applications Belt and Pulley Mechanism

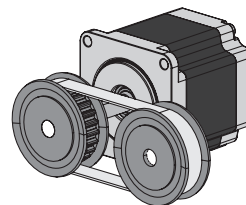

◇ Advantages

- The components for avoiding the concentration of the radial load on the shaft are no longer needed, making it easier to reduce the size of the equipment.
- It is easy to adjust belt tension to obtain a higher safety factor in the tension of the belt.

● Increased Torque

The torque characteristics of the Mini-Connector Type is equal to or higher than those of the Connector Type (excluding some types). Reduced positioning time is achieved by increasing torque.

2-Phase Motors PKP

Features Product Line

Product Number Product Line

Standard Type

High-Resolution Type

Flat Type

SH Geared Type

CS Geared Type

Common Specifications

Inner Wiring of Motor

5-Phase Motors PKP

Features Product Line

Product Number Product Line

Standard Type

High-Resolution Type

TS Geared Type

Common Specifications

Motor Pin Arrangement

Drivers for 2-Phase/5-Phase Motors

Peripheral Equipment

High-Resolution Type

This is a high-resolution stepper motor with a basic step angle of 0.9°. Stopping accuracy is improved.

● Increased Resolution (Compared to standard type)

The number of rotor teeth has doubled to 100, compared to 50 with the standard type. As a result, the basic step angle is 0.9°/step, which is half than the standard type.

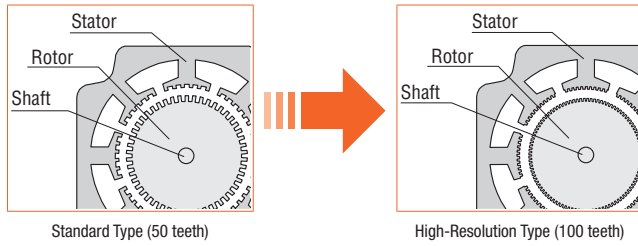

● Avoidance of Resonance Regions

If the pulse speed is within a resonance region, vibration may increase. Resonance regions can be avoided by switching to a high-resolution type.

● Improved Stopping Accuracy

Compared with the standard type (basic step angle 1.8°), the displacement angle of the motor is smaller than the frictional load applied to the motor.

The stopping accuracy in applications that constantly apply a frictional load, such as a ball screw mechanism, is therefore improved.

◇ Comparison of Angles and Torque Characteristics* (Reference value)

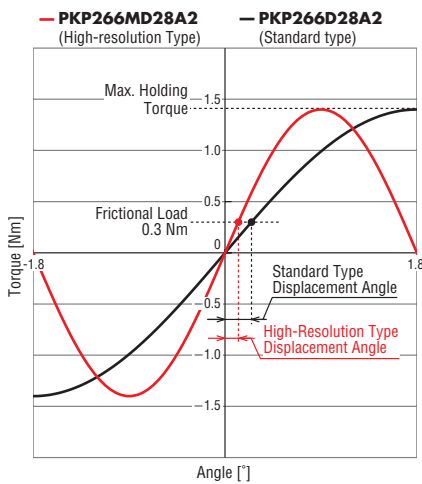

*For frictional load 0.3 Nm

◇ Comparison of Displacement Angles by Frictional Load* (Reference value)

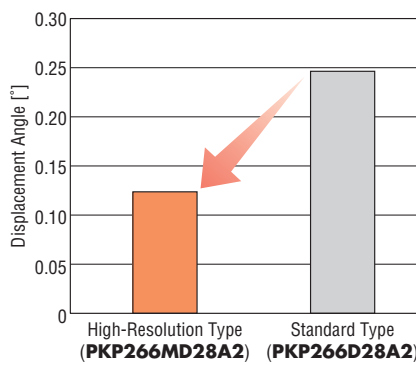

*For frictional load 0.3 Nm

◇ Example of Mechanism where a Constant Frictional Load is Applied

For example, in a ball screw mechanism, as the one shown in the figure, a frictional load is constantly applied to the motor by the guide block and guide rail, etc.

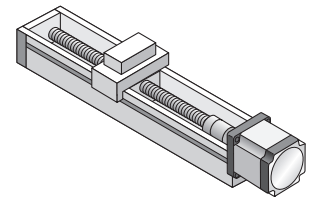

Flat Type

This is Oriental Motor's flattest type of 2-phase stepper motors.

● Flat and Lightweight Design

The motor can be installed in a narrow space.

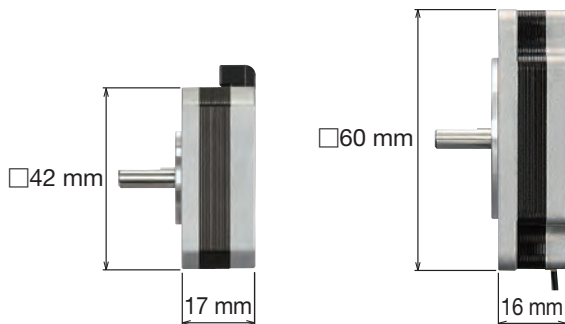

Maximum Holding Torque: 0.1 Nm
Mass: 0.11 kg

Maximum Holding Torque: 0.18 Nm
Mass: 0.2 kg

● With Harmonic Gears

◇ Attach the load to the surface of the flange to fix the load.

Example: Frame Size 51 mm



Gear Ratio 100
Maximum Holding Torque: 2.4 Nm
Mass: 0.32 kg

◇ Makes drives with large inertia possible.

Example: Frame Size 51 mm

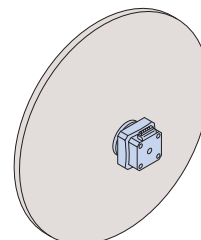

Inertia 0.12 kgm²
(Approximately 7 times the rotor inertia)
Inertial Load: Diameter 0.35 m,
Thickness 0.01 m
Mass 7.6 kg, Material Iron
Motor: Length 17 mm
Gear Ratio 100

Features of Geared Types

Using a geared type motor can provide advantages such as deceleration, high torque, and high resolution.

● Differentiating Features of the CS Geared Type and the SH Geared Type

Type		CS Geared Type	SH Geared Type	
Features		<ul style="list-style-type: none"> ● Center Shaft Configuration ● High Torque ● High Permissible Radial Load 	<ul style="list-style-type: none"> ● Wide Variety · 90 mm Frame Size and Unipolar Wiring · Includes Encoder · Many Gear Ratio Types 	
Frame Size	28 mm	Maximum Holding Torque [Nm]	0.4~0.8	0.3, 0.4
		Speed Range (Max. value) [r/min]	300~600	83~416
		Permissible Radial Load (Max. value) [N]	73	23
	42 mm	Maximum Holding Torque [Nm]	0.5~2	0.2~0.8
		Speed Range (Max. value) [r/min]	150~600	83~833
		Permissible Radial Load (Max. value) [N]	96	30
	60 mm	Maximum Holding Torque [Nm]	1.3~4.5	1~4
		Speed Range (Max. value) [r/min]	150~600	83~833
		Permissible Radial Load (Max. value) [N]	260	160
	90 mm	Maximum Holding Torque [Nm]	—	2.5~12
		Speed Range (Max. value) [r/min]	—	50~500
		Permissible Radial Load (Max. value) [N]	—	400

● Achieves Increased Torque with the Same Motor Frame Size

Switching to a geared type motor increases torque without changing the motor frame size.

This is effective when installation is not possible because the motor installation space is limited.



Standard Type	Motor Type	CS Geared Type
PKP243D15A2	Product Name	PKP243D15A2-CS20
0.35 Nm	Max. Holding Torque	2 Nm

CS Geared Type

The geared type with center shaft addresses torque, shaft load capacity and installation demands.

● Increased shaft load capacity reduces assembly time

Increased permissible radial load and permissible axial load can reduce assembly time.

◇ Permissible Radial Load and Permissible Axial Load

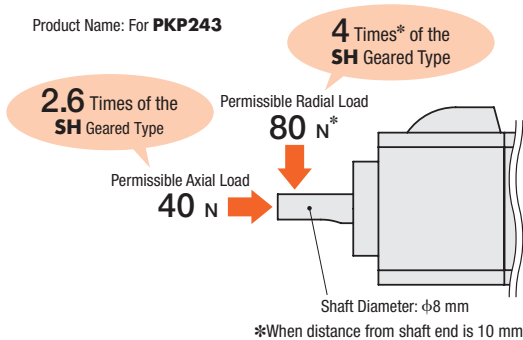

◇ Applications Belt and Pulley Mechanism

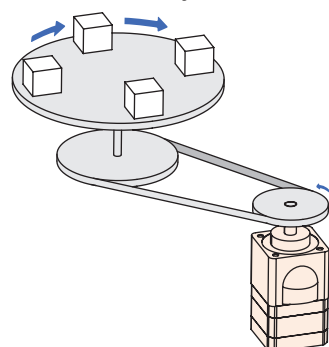

◇ Advantages

- Reduce adjustments during assembly because belt tension can be higher than with conventional products
- The components for avoiding the concentration of the radial load on the shaft are no longer needed
- The degree of freedom in pulley selection is increased

- 13 mm
- 20 mm
- 28 mm
- 35 mm
- 42 mm
- 50 mm
- 51 mm
- 56.4 mm
- 60 mm
- 61 mm
- 85 mm
- 90 mm

● Increase Torque Contributes to Reduced Size and Weight of the Motor

High torque, shorter motor length and a frame size that's one size smaller.

◇ Dimensions: (Unit = mm)

CS Geared Type (PKP243D15A2-CS20)

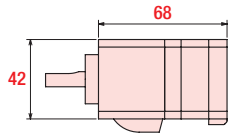

SH Geared Type (PKP264D14A2-SG7.2)

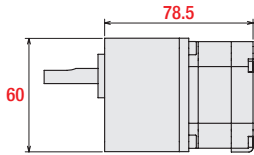

Maximum Holding Torque: Same
 Frame Size: **Reduced by 18 mm**
 Motor Length: **Reduced by 10.5 mm**
 Mass: **Reduced by 47 %**

◇ Torque Characteristics Comparison

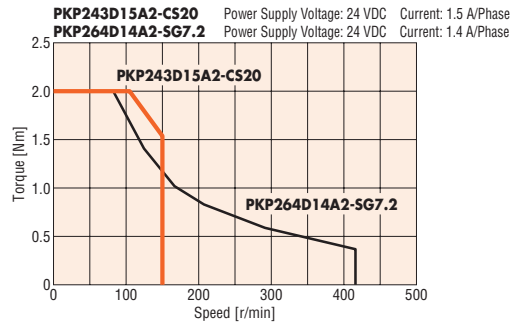

● Center Shaft Makes Designing Easier

A review of the gear structure has led to the center shaft. It is easier to design the installation plate. In addition, the degree of freedom for the cable outlet direction has been increased.

● Output Shaft now Placed in Center

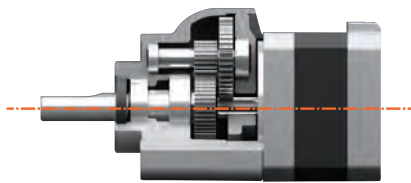

Internal Gearhead Structure Figure

● Installation Plate Designing Made Easier

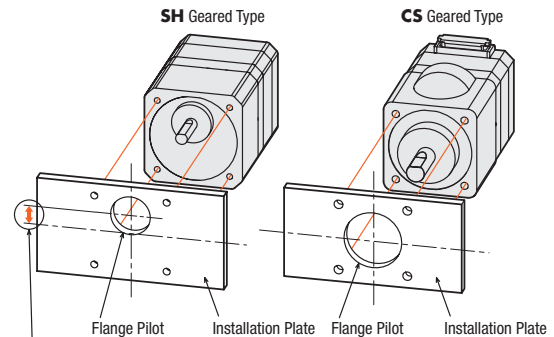

Amount of deviation between the central axis of the 4 installation holes and the central axis of the flange pilot

● Increased Degree of Freedom for Cable Outlet Direction

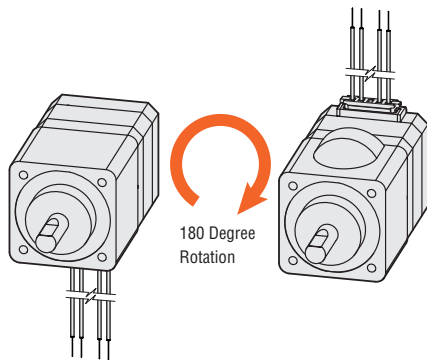

SH Geared Type

This type is well-suited for deceleration, increased torque, high resolution, and limited vibration. It experiences less backlash than conventional products.

● Wider Speed Range makes it Easier to Use than Conventional Products

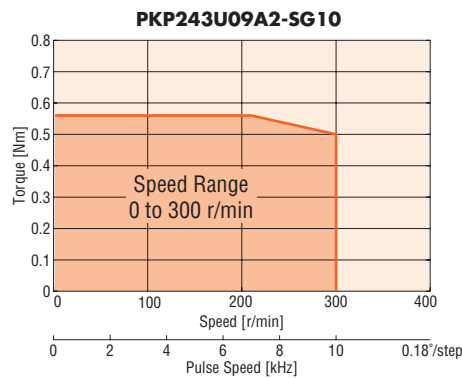
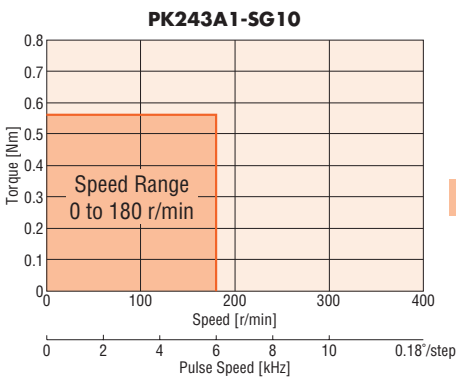

Product Line Equipped with Additional Functions to Broaden Applications

● With Encoder

(Available for standard type, high-resolution type, **SH** geared type)

● Main Specifications

Type	Standard Type	High-Resolution Type, SH Geared Type
Resolution	200 P/R, 400 P/R	400 P/R
Output Signals	A phase, B phase, Z phase (3ch)	

*A product line with resolution of 1000 P/R is available with standard type frame sizes of 42 mm and 56.4 mm. Check the details in the individual V-212 catalog.

◇ Motor Position Detection is Possible.

Monitoring the current position and detecting positional errors is possible. For example, comparing the command position and current position enables you to check the normal operation of the motor.

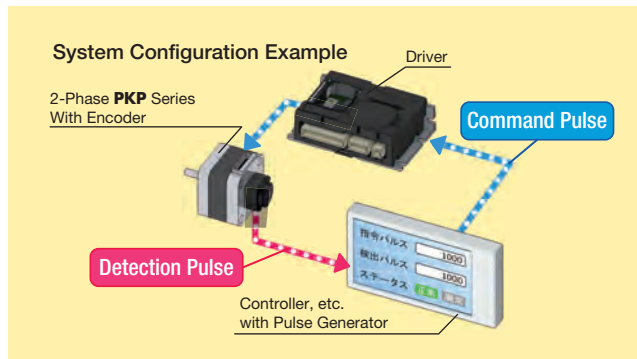

◇ Equipped with a Compact Encoder

● When frame size is 56.4 mm

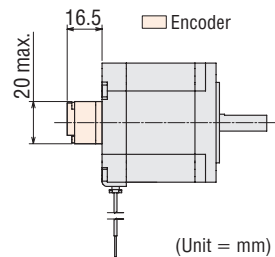

◇ High Reliability with Line Driver Output Circuit Type

Noise resistance is improved by differential output, and the wiring distance can be longer than with the voltage output type.

- The cables, which are convenient for wiring with an encoder, are available and sold separately.

● With Electromagnetic Brake

(Provided for standard type and high-resolution type)

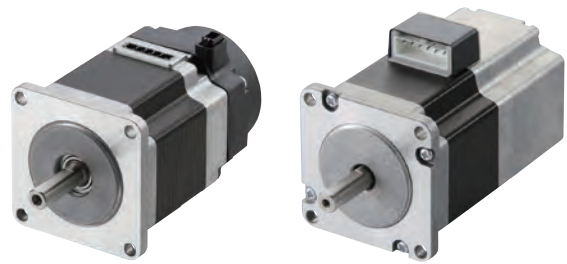

◇ Position Can Be Held When the Power Is OFF or a Power Failure Occurs.

This type features an electromagnetic brake that activates when the power is off.

When the power is accidentally cut off due to a power failure or other unexpected event, the electromagnetic brake holds the load in position to prevent it from dropping or moving. Also, the load can be held by the electromagnetic brake when the motor is stopped, and the heat generated by the motor can be curtailed by switching the motor current off.

2-Phase
Motors
PKP

Features
Product
Line

Product
Number
Product Line

Standard
Type

High-
Resolution
Type

Flat
Type

SH Geared
Type

CS Geared
Type

Common
Specifications

Inner
Wiring
of Motor

5-Phase
Motors
PKP

Features
Product
Line

Product
Number
Product Line

Standard
Type

High-
Resolution
Type

TS Geared
Type

Common
Specifications

Motor Pin
Arrangement

Drivers for
2-Phase/5-Phase
Motors

Peripheral
Equipment

Combined Drivers (Sold separately)

These are compact and lightweight bipolar drivers.

● Bipolar Driver CVD Series

The **CVD** Series offers the pulse input type and the RS-485 communication type drivers.

- Right Angle Type with Installation Plate
The connector points outward.



- With Installation Plate
The connector points upward.



- Without Installation Plate*
The connector points upward.



*Pulse input type only

● Bipolar Driver CVD Series S Type



· SPI Communication-Compatible



· Pulse Input-Compatible

□13 mm

□20 mm

□28 mm

□35 mm

□42 mm

□50 mm

□51 mm

□56.4 mm







□60 mm

□61 mm

□85 mm

□90 mm

Product Line

Motor Product Line (Basic Step Angle)	Frame Size, Wiring Type															
	13 mm		20 mm		28 mm		35 mm		42 mm		56.4 mm		60 mm		85 mm	
	Bipolar	Unipolar	Bipolar	Unipolar	Bipolar	Unipolar	Bipolar	Unipolar	Bipolar	Unipolar	Bipolar	Unipolar	Bipolar	Unipolar	Bipolar	Unipolar
Standard Type (1.8°)	●	—	○	○	●	●	●	●	●	●	●	●	○*3	○*3	○	○
 With Encoder	—	—	○	○	●	●	●	●	●	●	●	●	—	—	—	—
 With Electromagnetic Brake	—	—	—	—	●	●	●	●	●	●	●	●	—	—	—	—
High-Resolution Type (0.9°)	—	—	—	—	●	●	—	—	●	●	●	●	—	—	—	—
 With Electromagnetic Brake	—	—	—	—	—	—	—	—	●	●	●	●	—	—	—	—
Flat Type (0.018° to 1.8°)	—	—	—	—	—	—	—	—	●	—	—	—	○	—	—	—
 With Harmonic Gears	—	—	—	—	—	—	—	—	●*1	—	—	—	○*2	—	—	—
SH Geared Type (0.05° to 0.5°)	—	—	—	—	●	●	—	—	●	●	—	—	●	●	—	—
																
CS Geared Type (0.09° to 0.36°)	—	—	—	—	●	●	—	—	●	—	—	—	●	—	—	—
																

●: Connector Connection Method ○: Lead Wire Type

*1 Flat Type - 51 mm with Harmonic Gears.

*2 Flat Type - 61 mm with Harmonic Gears.

*3 This is the conventional **PK** Series.

System Configuration

Combination of the 2-Phase Stepper Motor PKP Series and the CVD Series Pulse Input Type Driver

An example of a system configuration using a host control device (with built-in pulse generator function) is shown below. Motors, drivers, and connection cables must be ordered individually.

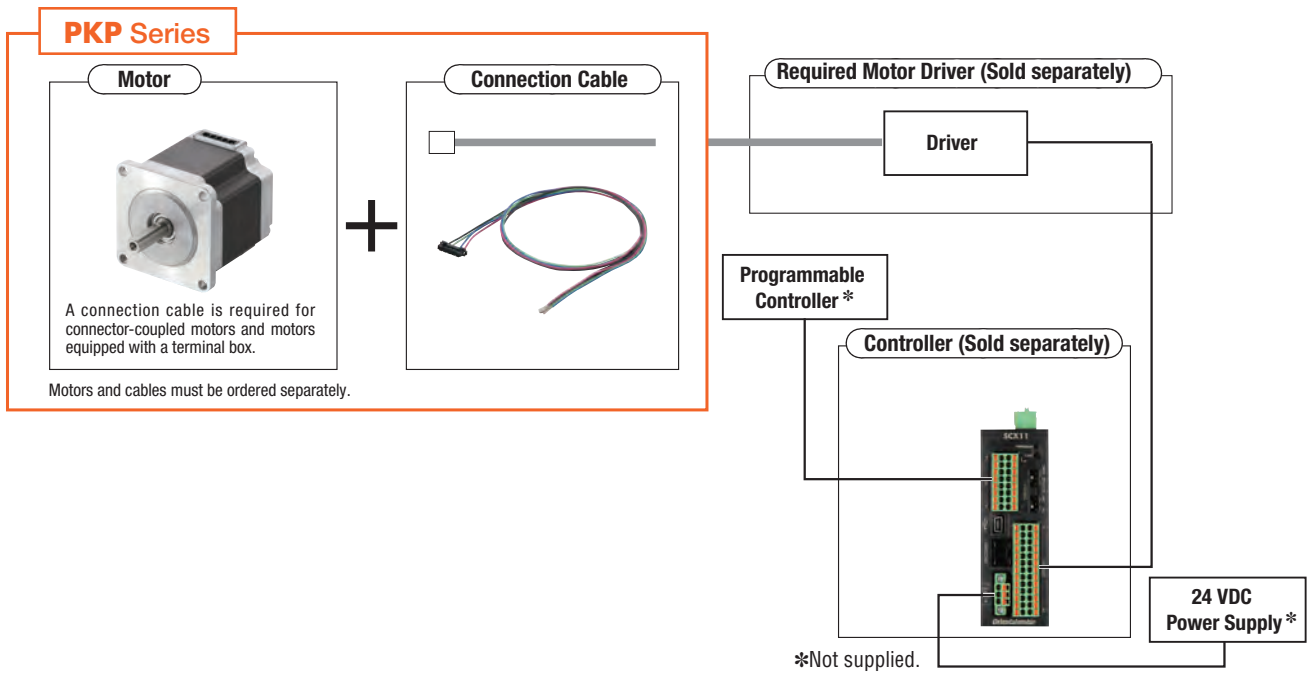

2-Phase
Motors
PKP

Features
Product
Line

Product
Number
Product Line

Standard
Type

High-
Resolution
Type

Flat
Type

SH Geared
Type

CS Geared
Type

Common
Specifications

Inner
Wiring
of Motor

5-Phase
Motors
PKP

Features
Product
Line

Product
Number
Product Line

Standard
Type

High-
Resolution
Type

TS Geared
Type

Common
Specifications

Motor
Pin
Arrangement

Drivers for
2-Phase/5-Phase
Motors

Peripheral
Equipment

Motor
Frame Size

13 mm

20 mm

28 mm

35 mm

42 mm

50 mm
 51 mm

56.4 mm

60 mm
 61 mm

85 mm
 90 mm

Product Number

Motor

PKP Series

◇ Standard Type/Standard Type with Electromagnetic Brake

PKP 2 6 4 D 28 A 2

① ② ③ ④ ⑥ ⑦ ⑧ ⑨

◇ High-Resolution Type/High-Resolution Type with Electromagnetic Brake

PKP 2 6 4 M D 28 A 2

① ② ③ ④ ⑤ ⑥ ⑦ ⑧ ⑨

①	Series Name	PKP: PKP Series
②		2: 2-Phase
③	Motor Frame Size	0: 13 mm 1: 20 mm 2: 28 mm 3: 35 mm 4: 42 mm 6: 56.4 mm 9: 85 mm
④	Motor Case Length	
⑤	Motor Type	Blank: Standard Type M: High-Resolution Type
⑥	Number of Lead Wires	D: 4 U: 5 or 6
⑦	Motor Winding Specification	
⑧	Shaft/Electromagnetic Brake	A: Single Shaft B: Double Shaft M: with Electromagnetic Brake
⑨	Reference Number	

● A product with a shaft diameter of $\phi 6.35$ mm is also available. For details, please contact the nearest Oriental Motor sales office.

◇ Standard Type with Encoder

PKP 2 6 4 D 28 A 2 - R2F L

① ② ③ ④ ⑥ ⑦ ⑧ ⑨ ⑩ ⑪

◇ High-Resolution Type with Encoder

PKP 2 4 3 M D 15 A 2 - R2F L

① ② ③ ④ ⑤ ⑥ ⑦ ⑧ ⑨ ⑩ ⑪

①	Series Name	PKP: PKP Series
②		2: 2-Phase
③	Motor Frame Size	1: 20 mm 2: 28 mm 3: 35 mm 4: 42 mm 6: 56.4 mm
④	Motor Case Length	
⑤	Motor Type	Blank: Standard Type M: High-Resolution Type
⑥	Number of Lead Wires	D: 4 U: 5 or 6
⑦	Motor Winding Specification	
⑧	Shaft	A: Single Shaft
⑨	Reference Number	
⑩	Encoder Resolution	R2E: 200 P/R R2F: 400 P/R
⑪	Encoder Output Circuit Type	L: Line Driver Output*

● A product with a shaft diameter of $\phi 6.35$ mm is also available. For details, please contact the nearest Oriental Motor sales office.

*An encoder whose output circuit type is voltage output is also available. For details, please contact the nearest Oriental Motor sales office.

◇ Flat Type

PKP 2 4 2 D 23 A 2

① ② ③ ④ ⑥ ⑦ ⑧ ⑩

PKP 2 6 2 F D 15 A W

① ② ③ ④ ⑤ ⑥ ⑦ ⑧ ⑨

◇ Flat Type with Harmonic Geared

PKP 2 4 2 D 23 A 2 - H 100

① ② ③ ④ ⑥ ⑦ ⑧ ⑩ ⑪ ⑫

PKP 2 6 2 F D 15 A W - H 100 S

① ② ③ ④ ⑤ ⑥ ⑦ ⑧ ⑨ ⑪ ⑫ ⑬

①	Series Name	PKP: PKP Series
②		2: 2-Phase
③	Motor Frame Size	4: 42 mm (Harmonic Geared type is 51 mm.) 6: 60 mm (Harmonic Geared type is 61 mm.)
④	Motor Case Length	
⑤	Motor Identification	F: Motor Frame Size 60 mm
⑥	Number of Lead Wires	D: 4
⑦	Motor Winding Specification	
⑧	Shaft	A: Single Shaft
⑨	Cable Type	Blank: Connector Coupled Type W: Lead Wire Type
⑩	Reference Number	
⑪	Geared Type	Blank: Flat Type H: Flat Type Harmonic Geared
⑫	Gear Ratio	
⑬	Gear Classification	

2-Phase
Motors
PKP

Features
Product
Line

Product
Number
Product Line

Standard
Type

High-
Resolution
Type

Flat
Type

SH Geared
Type

CS Geared
Type

Common
Specifications

Inner
Wiring
of Motor

5-Phase
Motors
PKP

Features
Product
Line

Product
Number
Product Line

Standard
Type

High-
Resolution
Type

T5 Geared
Type

Common
Specifications

Motor
Pin
Arrangement

Drivers for
2-Phase/5-Phase
Motors

Peripheral
Equipment

Motor
Frame Size

□13 mm

□20 mm

□28 mm

□35 mm

□42 mm

□50 mm
□51 mm

□56.4 mm

□60 mm
□61 mm

□85 mm
□90 mm

◇ **SH** Geared Type, **CS** Geared Type

PKP 2 4 3 D 23 B 2 - SG 18

① ② ③ ④ ⑤ ⑥ ⑦ ⑧ ⑨ ⑩

PK Series

◇ Standard Type

PK 2 6 4 J D B

① ② ③ ④ ⑤ ⑥ ⑦

● **Driver**

For details about drivers refer to page 128.

● **Connection Cable**

◇ Motor Connection Cable

LC 2 B 06 A

① ② ③ ④ ⑤

①	Cable	LC: Lead Wire with Connector
②		2: 2-Phase
③	Cable Type	B: Bipolar U: Unipolar
④	Cable Length	06: 0.6 m 10: 1 m
⑤	Reference Number	

◇ Electromagnetic Brake Connection Cable

LC M 02 A - 006

① ② ③ ④ ⑤

①	Cable	LC: Lead Wire with Connector
②	Cable Type	M: For Electromagnetic Brake
③	Number of Lead Wires	
④	Reference Number	
⑤	Cable Length	006: 0.6 m 010: 1 m

①	Series Name	PKP: PKP Series
②		2: 2-Phase
③	Motor Frame Size	2: 28 mm 4: 42 mm 6: 60 mm
④	Motor Case Length	
⑤	Number of Lead Wires	D: 4 U: 5 or 6
⑥	Motor Winding Specification	
⑦	Shaft	A: Single Shaft B: Double Shaft
⑧	Reference Number	
⑨	Geared Type	SG: SH Geared Type CS: CS Geared Type
⑩	Gear Ratio	

①	Series Name	PK: PK Series
②		2: 2-Phase
③	Motor Frame Size	6: 60 mm
④	Motor Case Length	
⑤	Motor Type	J: High-Torque Type
⑥	Number of Lead Wires	Blank: 6 D: 4
⑦	Shaft	A: Single Shaft B: Double Shaft

◇ Encoder Connection Cable

LC E 08 A - 006

① ② ③ ④ ⑤

①	Cable	LC: Connector Leads
②	Cable Type	E: For Encoder
③	Applicable Models	08: For Line Driver Output*
④	Reference Number	
⑤	Cable Length	006: 0.6 m

*The voltage output cable is also available.

For details, please contact your nearest Oriental Motor sales office.

Product Line

A connector-coupled motor requires a connection cable. Motors, drivers, and connection cables must be ordered individually. Refer to page 128 for details on drivers, and refer to page 142 for details on connection cables.

● Motor

◇ Standard Type

● Bipolar (4 lead wires)

Product Name (Single Shaft)	Product Name (Double Shaft)
PKP203D06A	PKP203D06B
PKP213D05A	PKP213D05B
PKP214D06A	PKP214D06B
PKP223D15A2	PKP223D15B2
PKP225D15A2	PKP225D15B2
PKP233D15A	PKP233D15B
PKP233D23A	PKP233D23B
PKP235D15A	PKP235D15B
PKP235D23A	PKP235D23B
PKP243D08A2	PKP243D08B2
PKP243D15A2	PKP243D15B2
PKP243D15A	PKP243D15B
PKP243D23A2	PKP243D23B2
PKP243D23A	PKP243D23B
PKP244D08A2	PKP244D08B2
PKP244D15A2	PKP244D15B2
PKP244D15A	PKP244D15B
PKP244D23A2	PKP244D23B2
PKP244D23A	PKP244D23B
PKP245D08A2	PKP245D08B2
PKP245D15A2	PKP245D15B2
PKP245D15A	PKP245D15B
PKP245D23A2	PKP245D23B2
PKP245D23A	PKP245D23B
PKP246D15A2	PKP246D15B2
PKP246D15A	PKP246D15B
PKP246D23A2	PKP246D23B2
PKP246D23A	PKP246D23B
PKP264D14A2	PKP264D14B2
PKP264D28A2	PKP264D28B2
PKP264D28A	PKP264D28B
PKP264D42A2	PKP264D42B2
PKP266D14A2	PKP266D14B2
PKP266D28A2	PKP266D28B2
PKP266D28A	PKP266D28B
PKP266D42A2	PKP266D42B2
PKP268D14A2	PKP268D14B2
PKP268D28A2	PKP268D28B2
PKP268D28A	PKP268D28B
PKP268D42A2	PKP268D42B2
PK264JDA	PK264JDB
PK266JDA	PK266JDB
PK267JDA	PK267JDB
PK269JDA	PK269JDB
PKP296D45A	PKP296D45B
PKP296D63A	PKP296D63B
PKP299D45A	PKP299D45B
PKP299D63A	PKP299D63B
PKP2913D45A	PKP2913D45B
PKP2913D56A	PKP2913D56B

*For details, please contact your nearest Oriental Motor sales office.

● Unipolar (5 or 6 lead wires)

Product Name (Single Shaft)	Product Name (Double Shaft)
PKP213U05A	PKP213U05B
PKP214U06A	PKP214U06B
PKP223U09A2	PKP223U09B2
PKP225U09A2	PKP225U09B2
PKP233U12A	PKP233U12B
PKP235U12A	PKP235U12B
PKP243U04A	PKP243U04B
PKP243U06A	PKP243U06B
PKP243U08A2	PKP243U08B2
PKP243U09A2	PKP243U09B2
PKP243U09A	PKP243U09B
PKP243U12A2	PKP243U12B2
PKP244U04A	PKP244U04B
PKP244U08A2	PKP244U08B2
PKP244U08A	PKP244U08B
PKP244U12A2	PKP244U12B2
PKP244U12A	PKP244U12B
PKP245U05A	PKP245U05B
PKP245U08A2	PKP245U08B2
PKP245U08A	PKP245U08B
PKP245U12A2	PKP245U12B2
PKP245U12A	PKP245U12B
PKP246U12A2	PKP246U12B2
PKP246U12A	PKP246U12B
PKP246U16A2	PKP246U16B2
PKP264U10A2	PKP264U10B2
PKP264U10A	PKP264U10B
PKP264U20A2	PKP264U20B2
PKP264U20A	PKP264U20B
PKP264U30A	PKP264U30B
PKP266U10A2	PKP266U10B2
PKP266U10A	PKP266U10B
PKP266U20A2	PKP266U20B2
PKP266U20A	PKP266U20B
PKP266U30A	PKP266U30B
PKP268U10A2	PKP268U10B2
PKP268U10A	PKP268U10B
PKP268U20A2	PKP268U20B2
PKP268U20A	PKP268U20B
PKP268U30A	PKP268U30B
PK264JA	PK264JB
PK266JA	PK266JB
PK267JA	PK267JB
PK269JA	PK269JB
PKP296U20A	PKP296U20B
PKP296U30A	PKP296U30B
PKP296U45A	PKP296U45B
PKP299U20A	PKP299U20B
PKP299U30A	PKP299U30B
PKP299U45A	PKP299U45B
PKP2913U20A	PKP2913U20B
PKP2913U40A	PKP2913U40B

2-Phase
Motors
PKP

Features
Product
Line

Product
Number
Product Line

Standard
Type

High-
Resolution
Type

Flat
Type

SH Geared
Type

CS Geared
Type

Common
Specifications

Inner
Wiring
of Motor

5-Phase
Motors
PKP

Features
Product
Line

Product
Number
Product Line

Standard
Type

High-
Resolution
Type

T5 Geared
Type

Common
Specifications

Motor
Pin
Arrangement

Drivers for
2-Phase/5-Phase
Motors

Peripheral
Equipment

Motor Frame Size

□13 mm

□20 mm

□28 mm

□35 mm

□42 mm

□50 mm

□51 mm

□56.4 mm

□60 mm

□61 mm

□85 mm

□90 mm

◇ Standard Type with Encoder

● Bipolar (4 lead wires)

Product Name
PKP213D05A-R2EL
PKP214D06A-R2EL
PKP223D15A2-R2EL
PKP225D15A2-R2EL
PKP233D15A-R2EL
PKP235D15A-R2EL
PKP243D15A2-R2□L
PKP243D23A2-R2□L
PKP244D15A2-R2□L
PKP244D23A2-R2□L
PKP245D15A2-R2□L
PKP245D23A2-R2□L
PKP246D15A2-R2□L
PKP246D23A2-R2□L
PKP264D14A2-R2□L
PKP264D28A2-R2□L
PKP264D42A2-R2□L
PKP266D14A2-R2□L
PKP266D28A2-R2□L
PKP266D42A2-R2□L
PKP268D14A2-R2□L
PKP268D28A2-R2□L
PKP268D42A2-R2□L

● Either **E** (200 P/R) or **F** (400 P/R) indicating the encoder resolution is entered where the box □ is located within the product name.

◇ Standard Type with Electromagnetic Brake

● Bipolar (4 lead wires)

Product Name
PKP223D15M2
PKP225D15M2
PKP233D15M
PKP235D15M
PKP243D23M2
PKP244D23M2
PKP245D23M2
PKP246D23M2
PKP264D28M2
PKP266D28M2
PKP268D28M2

◇ High-Resolution Type

● Bipolar (4 lead wires)

Product Name (Single Shaft)	Product Name (Double Shaft)
PKP223MD15A	PKP223MD15B
PKP225MD15A	PKP225MD15B
PKP243MD15A2	PKP243MD15B2
PKP243MD15A	PKP243MD15B
PKP244MD15A2	PKP244MD15B2
PKP244MD15A	PKP244MD15B
PKP245MD15A2	PKP245MD15B2
PKP246MD15A2	PKP246MD15B2
PKP264MD28A2	PKP264MD28B2
PKP264MD28A	PKP264MD28B
PKP266MD28A2	PKP266MD28B2
PKP266MD28A	PKP266MD28B
PKP268MD28A2	PKP268MD28B2
PKP268MD28A	PKP268MD28B

● Unipolar (5 or 6 lead wires)

Product Name
PKP213U05A-R2EL
PKP214U06A-R2EL
PKP223U09A2-R2EL
PKP225U09A2-R2EL
PKP233U12A-R2EL
PKP235U12A-R2EL
PKP243U09A2-R2□L
PKP244U12A2-R2□L
PKP245U12A2-R2□L
PKP246U12A2-R2□L
PKP264U10A2-R2□L
PKP264U20A2-R2□L
PKP266U10A2-R2□L
PKP266U20A2-R2□L
PKP268U10A2-R2□L
PKP268U20A2-R2□L

● Either **E** (200 P/R) or **F** (400 P/R) indicating the encoder resolution is entered where the box □ is located within the product name.

● Unipolar (6 lead wires)

Product Name
PKP223U09M2
PKP225U09M2
PKP233U12M
PKP235U12M
PKP243U09M
PKP244U12M
PKP245U12M
PKP246U12M
PKP264U20M
PKP266U20M
PKP268U20M

● Unipolar (5 or 6 lead wires)

Product Name (Single Shaft)	Product Name (Double Shaft)
PKP223MU09A	PKP223MU09B
PKP225MU09A	PKP225MU09B
PKP243MU09A	PKP243MU09B
PKP243MU12A2	PKP243MU12B2
PKP244MU12A2	PKP244MU12B2
PKP244MU12A	PKP244MU12B
PKP245MU12A2	PKP245MU12B2
PKP246MU12A2	PKP246MU12B2
PKP264MU20A2	PKP264MU20B2
PKP264MU20A	PKP264MU20B
PKP266MU20A2	PKP266MU20B2
PKP266MU20A	PKP266MU20B
PKP268MU20A2	PKP268MU20B2
PKP268MU20A	PKP268MU20B

◇ High-Resolution Type with Electromagnetic Brake

● Bipolar (4 lead wires)

Product Name
PKP243MD15M
PKP244MD15M
PKP264MD28M
PKP266MD28M
PKP268MD28M

◇ Flat Type

● Bipolar (4 lead wires)

Product Name (Single Shaft)
PKP242D23A2
PKP262FD15AW

◇ SH Geared Type

● Bipolar (4 lead wires)

Product Name (Single Shaft)	Product Name (Double Shaft)
PKP223D15A-SG7.2	PKP223D15B-SG7.2
PKP223D15A-SG9	PKP223D15B-SG9
PKP223D15A-SG10	PKP223D15B-SG10
PKP223D15A-SG18	PKP223D15B-SG18
PKP223D15A-SG36	PKP223D15B-SG36
PKP243D15A2-SG3.6	PKP243D15B2-SG3.6
PKP243D23A2-SG3.6	PKP243D23B2-SG3.6
PKP243D15A2-SG7.2	PKP243D15B2-SG7.2
PKP243D23A2-SG7.2	PKP243D23B2-SG7.2
PKP243D15A2-SG9	PKP243D15B2-SG9
PKP243D23A2-SG9	PKP243D23B2-SG9
PKP243D15A2-SG10	PKP243D15B2-SG10
PKP243D23A2-SG10	PKP243D23B2-SG10
PKP243D15A2-SG18	PKP243D15B2-SG18
PKP243D23A2-SG18	PKP243D23B2-SG18
PKP243D15A2-SG36	PKP243D15B2-SG36
PKP243D23A2-SG36	PKP243D23B2-SG36
PKP264D14A2-SG3.6	PKP264D14B2-SG3.6
PKP264D28A2-SG3.6	PKP264D28B2-SG3.6
PKP264D14A2-SG7.2	PKP264D14B2-SG7.2
PKP264D28A2-SG7.2	PKP264D28B2-SG7.2
PKP264D14A2-SG9	PKP264D14B2-SG9
PKP264D28A2-SG9	PKP264D28B2-SG9
PKP264D14A2-SG10	PKP264D14B2-SG10
PKP264D28A2-SG10	PKP264D28B2-SG10
PKP264D14A2-SG18	PKP264D14B2-SG18
PKP264D28A2-SG18	PKP264D28B2-SG18
PKP264D14A2-SG36	PKP264D14B2-SG36
PKP264D28A2-SG36	PKP264D28B2-SG36

● Unipolar (6 lead wires)

Product Name
PKP243MU09M
PKP244MU12M
PKP264MU20M
PKP266MU20M
PKP268MU20M

◇ Flat Type with Harmonic Geared

● Bipolar (4 lead wires)

Product Name (Single Shaft)
PKP242D23A2-H50
PKP242D23A2-H100
PKP262FD15AW-H50S
PKP262FD15AW-H100S

● Unipolar (5 or 6 lead wires)

Product Name (Single Shaft)	Product Name (Double Shaft)
PKP223U09A-SG7.2	PKP223U09B-SG7.2
PKP223U09A-SG9	PKP223U09B-SG9
PKP223U09A-SG10	PKP223U09B-SG10
PKP223U09A-SG18	PKP223U09B-SG18
PKP223U09A-SG36	PKP223U09B-SG36
PKP243U09A2-SG3.6	PKP243U09B2-SG3.6
PKP243U09A2-SG7.2	PKP243U09B2-SG7.2
PKP243U09A2-SG9	PKP243U09B2-SG9
PKP243U09A2-SG10	PKP243U09B2-SG10
PKP243U09A2-SG18	PKP243U09B2-SG18
PKP243U09A2-SG36	PKP243U09B2-SG36
PKP264U10A2-SG3.6	PKP264U10B2-SG3.6
PKP264U20A2-SG3.6	PKP264U20B2-SG3.6
PKP264U10A2-SG7.2	PKP264U10B2-SG7.2
PKP264U20A2-SG7.2	PKP264U20B2-SG7.2
PKP264U10A2-SG9	PKP264U10B2-SG9
PKP264U20A2-SG9	PKP264U20B2-SG9
PKP264U10A2-SG10	PKP264U10B2-SG10
PKP264U20A2-SG10	PKP264U20B2-SG10
PKP264U10A2-SG18	PKP264U10B2-SG18
PKP264U20A2-SG18	PKP264U20B2-SG18
PKP264U10A2-SG36	PKP264U10B2-SG36
PKP264U20A2-SG36	PKP264U20B2-SG36

2-Phase Motors PKP

Features Product Line

Product Number Product Line

Standard Type

High-Resolution Type

Flat Type

SH Geared Type

CS Geared Type

Common Specifications

Inner Wiring of Motor

5-Phase Motors PKP

Features Product Line

Product Number Product Line

Standard Type

High-Resolution Type

T5 Geared Type

Common Specifications

Motor Pin Arrangement

Drivers for 2-Phase/5-Phase Motors

Peripheral Equipment

◇ **CS Geared Type**

● **Bipolar (4 lead wires)**

Product Name (Single Shaft)	Product Name (Double Shaft)
PKP223D15A-CS10	PKP223D15B-CS10
PKP223D15A-CS15	PKP223D15B-CS15
PKP223D15A-CS20	PKP223D15B-CS20
PKP243D15A2-CS5	PKP243D15B2-CS5
PKP243D23A2-CS5	PKP243D23B2-CS5
PKP243D15A2-CS10	PKP243D15B2-CS10
PKP243D23A2-CS10	PKP243D23B2-CS10
PKP243D15A2-CS15	PKP243D15B2-CS15
PKP243D23A2-CS15	PKP243D23B2-CS15
PKP243D15A2-CS20	PKP243D15B2-CS20
PKP243D23A2-CS20	PKP243D23B2-CS20
PKP264D14A2-CS5	PKP264D14B2-CS5
PKP264D28A2-CS5	PKP264D28B2-CS5
PKP264D14A2-CS10	PKP264D14B2-CS10
PKP264D28A2-CS10	PKP264D28B2-CS10
PKP264D14A2-CS15	PKP264D14B2-CS15
PKP264D28A2-CS15	PKP264D28B2-CS15
PKP264D14A2-CS20	PKP264D14B2-CS20
PKP264D28A2-CS20	PKP264D28B2-CS20

● **Unipolar (6 lead wires)**

Product Name (Single Shaft)	Product Name (Double Shaft)
PKP223U09A-CS10	PKP223U09B-CS10
PKP223U09A-CS15	PKP223U09B-CS15
PKP223U09A-CS20	PKP223U09B-CS20

● **Driver**

Refer to page 128 for details on drivers.

● **Connection Cable**

Refer to the dimensions page for each product for information on connection cables and applicable motors. Some cables are available that can be directly connected to the recommended driver. See page 142.

■ **Included**

Type	Included	Surge Suppressor	Parallel Key	Motor Mounting Screw	Operating Manual
Standard Type High-Resolution Type	With Encoder	—	—	—	1 Copy
	With Electromagnetic Brake	1 pc.	—	—	
Flat Type	—	—	—	—	
SH Geared Type	Frame Size 28 mm Frame Size 42 mm Frame Size 60 mm	—	—	—	— *
	Frame Size 90 mm	—	1 pc.	M6×18 P1.0 (4 Screws)	
CS Geared Type	Frame Size 28 mm Frame Size 42 mm	—	—	—	—
	Frame Size 60 mm	—	1 pc.	M4×60 P0.7 (4 Screws)	

*An operating manual is included with encoder types.

■ **How to Read Specifications**

Maximum Holding Torque	: This is the maximum holding torque (holding force) the motor has when power is supplied (at rated current) but the motor is not rotating. (With geared types, the value of holding torque considers the permissible strength of the gear.)
Permissible Torque	: The permissible torque represents the maximum value limited by the mechanical strength of the output gear shaft when operated at a constant speed. For the SH geared types and CS geared types, the total torque including acceleration and deceleration torque should not exceed the permissible torque.
Maximum Instantaneous Torque	: This is the maximum torque that can be applied to the gear output shaft during acceleration/deceleration such when an inertial load is started and stopped.

Standard Type Frame Size 13 mm (Bipolar 4 lead wires)

Mini-Connector Type

Specifications

Product Name	Maximum Holding Torque [Nm]	Rotor Inertia J: kgm ²	Rated Current A/Phase	Voltage VDC	Winding Resistance Ω/Phase	Inductance mH/Phase	Basic Step Angle	Recommended Driver Product Name*
PKP203D06□	0.0075	0.41 × 10 ⁻⁷	0.6	1.9	3.2	1.1	1.8°	CVD206BR-K

● The box □ in the product name indicates the shaft **A** (single shaft) or **B** (double shaft).

*See "Drivers for 2-Phase / 5-Phase Motors" page for drivers that can be used in combination.

Note

● Be sure to set the driver current at or below the motor rated current. If the motor rated current is exceeded, the product will be damaged.

Speed – Torque Characteristics (Reference values) *fs*: Max. Starting Frequency

PKP203D06A/PKP203D06B

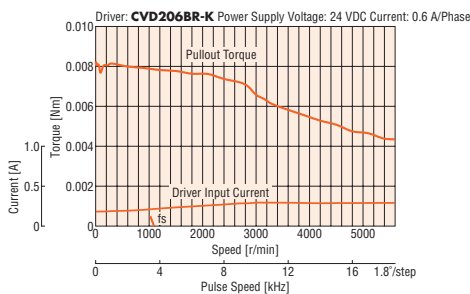

Note

● Data for the speed – torque characteristics is based on Oriental Motor's internal measurement conditions. If the conditions are changed, the characteristics may also change as a result.

● Depending on the driving conditions, a considerable amount of heat may be generated by the motor. Be sure to keep the motor case temperature at 100°C or less.

● The characteristics are the same if combined with an RS-485 communication type driver.

Dimensions (Unit: mm)

Motor

Product Name	Mass [kg]
PKP203D06A	0.021
PKP203D06B	

Applicable Connector

Connector Housing: DF52-4P-0.8C

(HIROSE ELECTRIC CO., LTD.)

Contact: DF52-2832PCF

(HIROSE ELECTRIC CO., LTD.)

Crimp Tool: AP105-DF52-2832P

(HIROSE ELECTRIC CO., LTD.)

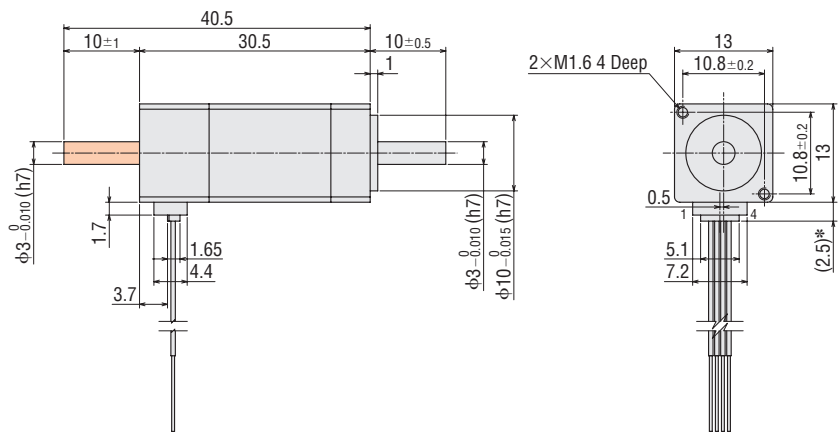

*With connection cable

● These dimensions are for double shaft motors.

For single shaft motors, ignore the shaded areas.

Connection Cable (Sold separately)

◇ Motor Connection Cable

Product Name	Length L [m]
LC2B10G	1

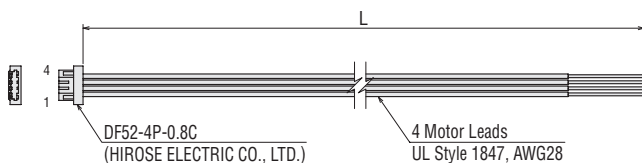

Note

● The voltage applied to the cable should be 30 V or lower. If 30 V is exceeded, the cable will be damaged.

Inner Wiring Diagram of Motor

Wiring Diagram No.: Model D⑧

● Refer to the motor inner wiring page for an inner wiring diagram of the motor.

2-Phase Motors PKP

Features Product Line

Product Number Product Line

Standard Type

High-Resolution Type

Flat Type

SH Geared Type

CS Geared Type

Common Specifications

Inner Wiring of Motor

5-Phase Motors PKP

Features Product Line

Product Number Product Line

Standard Type

High-Resolution Type

TS Geared Type

Common Specifications

Motor Pin Arrangement

Drivers for 2-Phase/5-Phase Motors

Peripheral Equipment

Standard Type Frame Size 20 mm (Bipolar 4 lead wires)

Lead Wire Type

□13 mm

□20 mm

□28 mm

□35 mm

□42 mm

□50 mm

□51 mm

□56.4 mm

□60 mm

□61 mm

□85 mm

□90 mm

Specifications

Product Name	Maximum Holding Torque [Nm]	Rotor Inertia J: kgm ²	Rated Current A/Phase	Voltage VDC	Winding Resistance Ω/Phase	Inductance mH/Phase	Basic Step Angle	Recommended Driver Product Name*
PKP213D05□	0.02	1.6×10 ⁻⁷	0.5	4.25	8.5	4.1	1.8°	CVD205BR-K
PKP214D06□	0.036	2.9×10 ⁻⁷	0.6	3.9	6.5	3.5		CVD206BR-K

● The box □ in the product name indicates the shaft **A** (single shaft) or **B** (double shaft).

*See "Drivers for 2-Phase / 5-Phase Motors" page for drivers that can be used in combination.

Note

● Be sure to set the driver current at or below the motor rated current. If the motor rated current is exceeded, the product will be damaged.

Speed – Torque Characteristics (Reference values) fs: Max. Starting Frequency

PKP213D05A/PKP213D05B

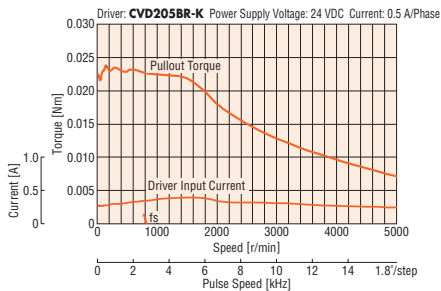

PKP214D06A/PKP214D06B

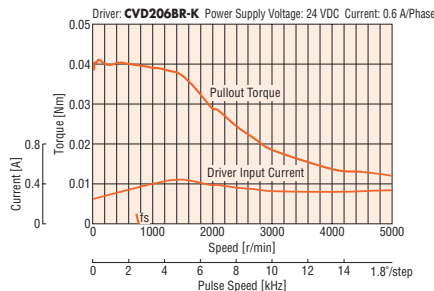

Note

● Data for the speed – torque characteristics is based on Oriental Motor's internal measurement conditions. If the conditions are changed, the characteristics may also change as a result.

● Depending on the driving conditions, a considerable amount of heat may be generated by the motor. Be sure to keep the motor case temperature at 100°C max.

● The characteristics are the same when RS-485 communication type driver is used in combination.

Dimensions (Unit: mm)

Motor

Product Name	L1	L2	Mass [kg]
PKP213D05A	30	—	0.05
PKP213D05B		38	
PKP214D06A	40	—	0.07
PKP214D06B		48	

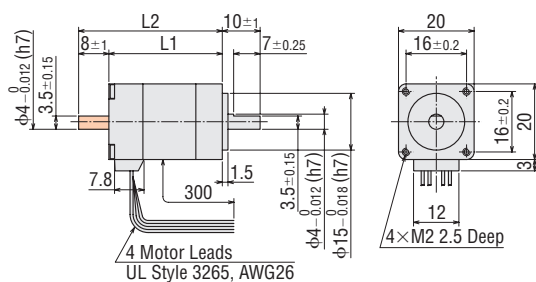

● These dimensions are for double shaft motors.

For single shaft motors, ignore the shaded areas.

● The back shaft side of the double shaft model is entirely shaft flat.

Inner Wiring Diagram of Motor

Wiring Diagram No.: Model C⑤

● See "Inner Wiring Diagram of Motor" page for the inner wiring diagram of the motor.

Standard Type Frame Size 20 mm (Unipolar 5 lead wires)

Lead Wire Type

Specifications

Product Name	Maximum Holding Torque [Nm]	Rotor Inertia J: kgm ²	Rated Current A/Phase	Voltage VDC	Winding Resistance Ω/Phase	Inductance mH/Phase	Basic Step Angle
PKP213U05□	0.014	1.6×10 ⁻⁷	0.5	4.25	8.5	2.9	1.8°
PKP214U06□	0.026	2.9×10 ⁻⁷	0.6	4.2	7	2.4	

● The box □ in the product name indicates the shaft **A** (single shaft) or **B** (double shaft).
 *See "Drivers for 2-Phase / 5-Phase Motors" page for details on the recommended drivers.

Note

● Be sure to set the driver current at or below the motor rated current. If the motor rated current is exceeded, the product will be damaged.

Speed – Torque Characteristics (Reference values) fs: Max. Starting Frequency

PKP213U05A/PKP213U05B

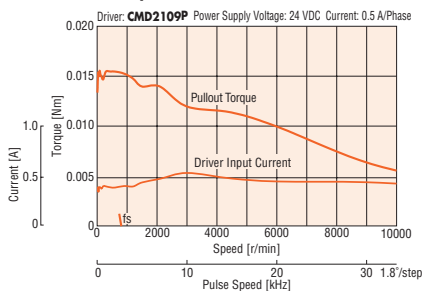

PKP214U06A/PKP214U06B

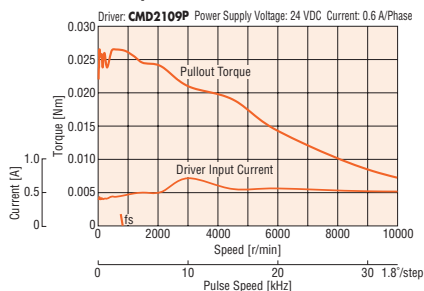

Note

● Data for the speed – torque characteristics is based on Oriental Motor's internal measurement conditions. If the conditions are changed, the characteristics may also change as a result.
 ● Depending on the driving conditions, a considerable amount of heat may be generated by the motor. Be sure to keep the motor case temperature at 100°C max.

Dimensions (Unit: mm)

● Motor

Product Name	L1	L2	Mass [kg]
PKP213U05A	30	—	0.05
PKP213U05B		38	
PKP214U06A	40	—	0.07
PKP214U06B		48	

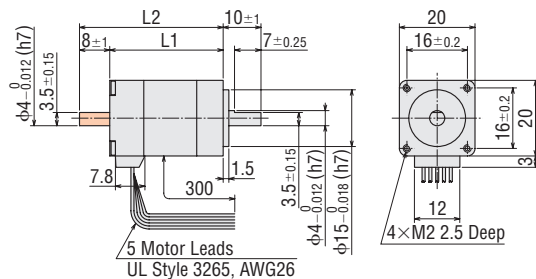

● These dimensions are for double shaft motors.
 For single shaft motors, ignore the shaded areas.
 ● The back shaft side of the double shaft model is entirely shaft flat.

Inner Wiring Diagram of Motor

Wiring Diagram No.: Model C⑥

● See "Inner Wiring Diagram of Motor" page for the inner wiring diagram of the motor.

2-Phase Motors
PKP

Features Product Line

Product Number Product Line

Standard Type

High-Resolution Type

Flat Type

SH Geared Type

CS Geared Type

Common Specifications

Inner Wiring of Motor

5-Phase Motors
PKP

Features Product Line

Product Number Product Line

Standard Type

High-Resolution Type

T5 Geared Type

Common Specifications

Motor Pin Arrangement

Drivers for 2-Phase/5-Phase Motors

Peripheral Equipment

Standard Type with Encoder Frame Size 20 mm (Bipolar 4 lead wires)

Lead Wire Type

13 mm

20 mm

28 mm

35 mm

42 mm

50 mm

51 mm

56.4 mm

60 mm

61 mm

85 mm

90 mm

Specifications

Product Name	Maximum Holding Torque [Nm]	Rotor Inertia J: kgm ²	Rated Current A/Phase	Voltage VDC	Winding Resistance Ω/Phase	Inductance mH/Phase	Basic Step Angle	Recommended Driver Product Name*
PKP213D05A-R2EL	0.02	1.66×10^{-7}	0.5	4.25	8.5	4.1	1.8°	CVD205BR-K
PKP214D06A-R2EL	0.036	2.96×10^{-7}	0.6	3.9	6.5	3.5		CVD206BR-K

● See "Common Specifications" page for encoder specifications.

*See "Drivers for 2-Phase / 5-Phase Motors" page for drivers that can be used in combination.

Note

● Be sure to set the driver current at or below the motor rated current. If the motor rated current is exceeded, the product will be damaged.

Speed – Torque Characteristics (Reference values) fs: Max. Starting Frequency

PKP213D05A-R2EL

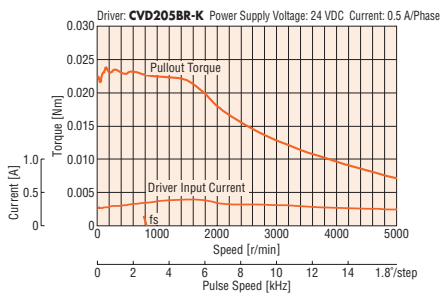

PKP214D06A-R2EL

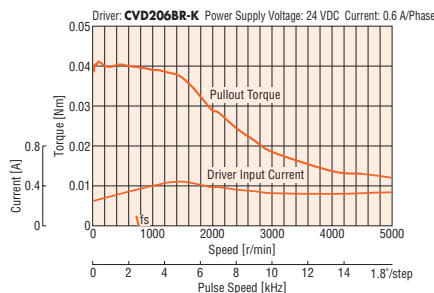

Note

● Data for the speed – torque characteristics is based on Oriental Motor's internal measurement conditions. If the conditions are changed, the characteristics may also change as a result.

● Depending on the driving conditions, a considerable amount of heat may be generated by the motor. To protect the encoder, be sure to keep the motor case temperature at 85°C max.

● The characteristics are the same when RS-485 communication type driver is used in combination.

Dimensions (Unit: mm)

Motor

Product Name	L	Mass [kg]
PKP213D05A-R2EL	46.5	0.06
PKP214D06A-R2EL	56.5	0.08

● Applicable Connector (Molex)

	Encoder
Connector Housing	51021-0800
Contact	50079-8100
Crimping Tool	57177-5000

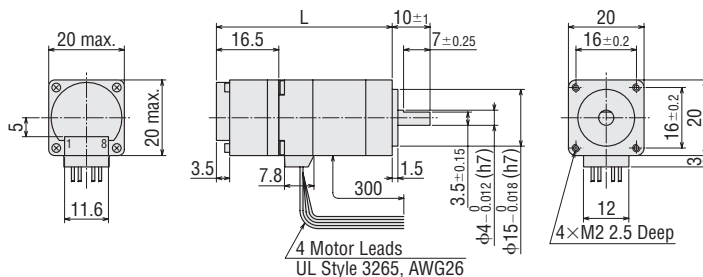

Connection Cable (Sold separately)

Encoder Connection Cable

Product Name	Length L [m]
LCE08A-006	0.6

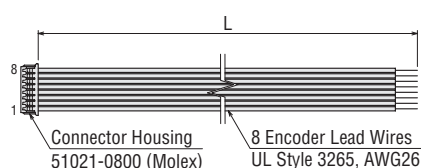

Inner Wiring Diagram of Motor

Wiring Diagram No.: Model C⑤

● See "Inner Wiring Diagram of Motor" page for the inner wiring diagram of the motor.

Standard Type with Encoder Frame Size 20 mm (Unipolar 5 lead wires)

Lead Wire Type

2-Phase
Motors
PKP

Features
Product
Line

Product
Number
Product Line

Standard
Type

High-
Resolution
Type

Flat
Type

SH Geared
Type

CS Geared
Type

Common
Specifications

Inner
Wiring
of Motor

5-Phase
Motors
PKP

Features
Product
Line

Product
Number
Product Line

Standard
Type

High-
Resolution
Type

TS Geared
Type

Common
Specifications

Motor
Pin
Arrangement

Drivers for
2-Phase/5-Phase
Motors

Peripheral
Equipment

Specifications

Product Name	Maximum Holding Torque [Nm]	Rotor Inertia J: kgm ²	Rated Current A/Phase	Voltage VDC	Winding Resistance Ω/Phase	Inductance mH/Phase	Basic Step Angle
PKP213U05A-R2EL	0.014	1.66×10 ⁻⁷	0.5	4.25	8.5	2.9	1.8°
PKP214U06A-R2EL	0.026	2.96×10 ⁻⁷	0.6	4.2	7	2.4	

● See "Common Specifications" page for encoder specifications.

*See "Drivers for 2-Phase / 5-Phase Motors" page for details on the recommended drivers.

Note

● Be sure to set the driver current at or below the motor rated current. If the motor rated current is exceeded, the product will be damaged.

Speed – Torque Characteristics (Reference values) fs: Max. Starting Frequency

PKP213U05A-R2EL

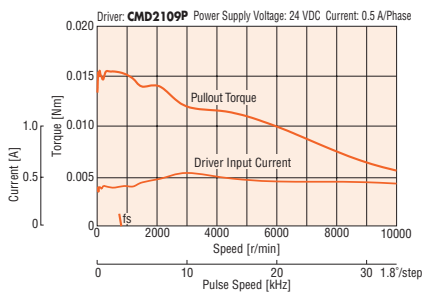

PKP214U06A-R2EL

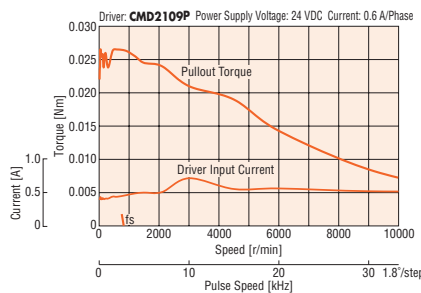

Note

● Data for the speed – torque characteristics is based on Oriental Motor's internal measurement conditions. If the conditions are changed, the characteristics may also change as a result.

● Depending on the driving conditions, a considerable amount of heat may be generated by the motor. To protect the encoder, be sure to keep the motor case temperature at 85°C max.

Dimensions (Unit: mm)

Motor

Product Name	L	Mass [kg]
PKP213U05A-R2EL	46.5	0.06
PKP214U06A-R2EL	56.5	0.08

● Applicable Connector (Molex)

	Encoder
Connector Housing	51021-0800
Contact	50079-8100
Crimping Tool	57177-5000

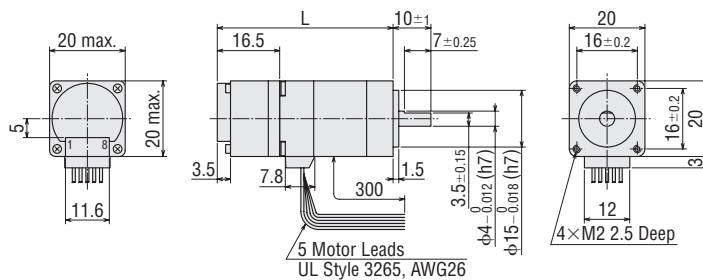

Connection Cable (Sold separately)

Encoder Connection Cable

Product Name	Length L [m]
LCE08A-006	0.6

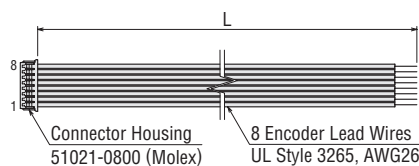

Inner Wiring Diagram of Motor

Wiring Diagram No.: Model C⑥

● See "Inner Wiring Diagram of Motor" page for the inner wiring diagram of the motor.

Standard Type Frame Size 28 mm (Bipolar 4 lead wires)

Connector Type

□13 mm

□20 mm

□28 mm

□35 mm

□42 mm

□50 mm

□51 mm

□56.4 mm

□60 mm

□61 mm

□85 mm

□90 mm

Specifications

Product Name	Maximum Holding Torque [Nm]	Rotor Inertia J: kgm ²	Rated Current A/Phase	Voltage VDC	Winding Resistance Ω/Phase	Inductance mH/Phase	Basic Step Angle	Recommended Driver Product Name*
PKP223D15□2	0.095	9×10 ⁻⁷	1.5	1.77	1.18	0.96	1.8°	CVD215BR-K
PKP225D15□2	0.19	18×10 ⁻⁷		3	2	1.6		

● The box □ in the product name indicates the shaft **A** (single shaft) or **B** (double shaft).

*See "Drivers for 2-Phase / 5-Phase Motors" page for drivers that can be used in combination.

Note

● Be sure to set the driver current at or below the motor rated current. If the motor rated current is exceeded, the product will be damaged.

Speed – Torque Characteristics (Reference values) fs: Max. Starting Frequency

PKP223D15A2/ PKP223D15B2

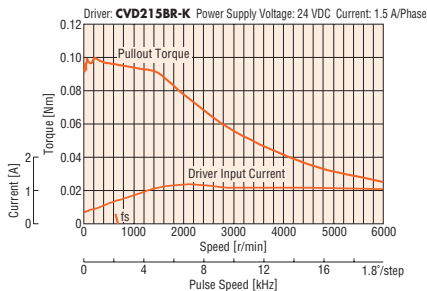

PKP225D15A2/ PKP225D15B2

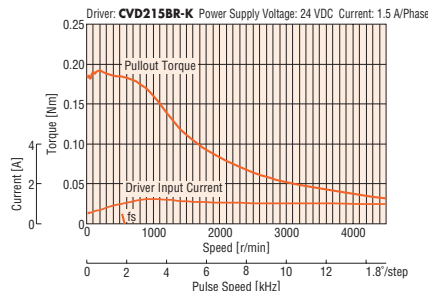

Note

● Data for the speed – torque characteristics is based on Oriental Motor's internal measurement conditions. If the conditions are changed, the characteristics may also change as a result.

● Depending on the driving conditions, a considerable amount of heat may be generated by the motor. Be sure to keep the motor case temperature at 100°C max.

● The characteristics are the same when RS-485 communication type driver is used in combination.

Dimensions (Unit: mm)

Motor

Product Name	L1	L2	Mass [kg]
PKP223D15A2	32	—	0.11
PKP223D15B2		42	
PKP225D15A2	51.5	—	0.2
PKP225D15B2		61.5	

Applicable Connector

Connector Housing: 51065-0600 (Molex)

Contact: 50212-8100 (Molex)

Crimp Tool: 57176-5000 (Molex)

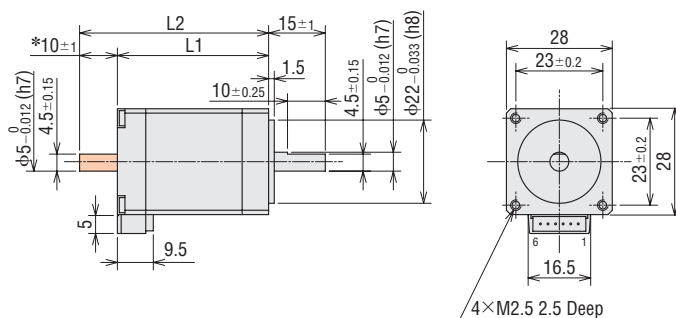

*The length of the shaft flat on the double shaft model is 10±0.25.

● These dimensions are for double shaft motors.

For single shaft motors, ignore the shaded areas.

Connection Cable (Sold separately)

Motor Connection Cable

Product Name	Length L [m]
LC2B06A	0.6
LC2B10A	1

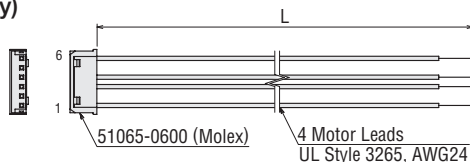

Inner Wiring Diagram of Motor

Wiring Diagram No.: Model B③

● See "Inner Wiring Diagram of Motor" page for the inner wiring diagram of the motor.

Standard Type Frame Size 28 mm (Unipolar 6 lead wires)

Connector Type

Specifications

Product Name	Maximum Holding Torque [Nm]	Rotor Inertia J: kgm ²	Rated Current A/Phase	Voltage VDC	Winding Resistance Ω/Phase	Inductance mH/Phase	Basic Step Angle
PKP223U09□2	0.075	9×10 ⁻⁷	0.95	2.95	3.11	1.44	1.8°
PKP225U09□2	0.135	18×10 ⁻⁷		4.4	4.6	2.11	

● The box □ in the product name indicates the shaft **A** (single shaft) or **B** (double shaft).

*See "Drivers for 2-Phase / 5-Phase Motors" page for details on the recommended drivers.

Note

● Be sure to set the driver current at or below the motor rated current. If the motor rated current is exceeded, the product will be damaged.

Speed – Torque Characteristics (Reference values) fs: Max. Starting Frequency

PKP223U09A2/ PKP223U09B2

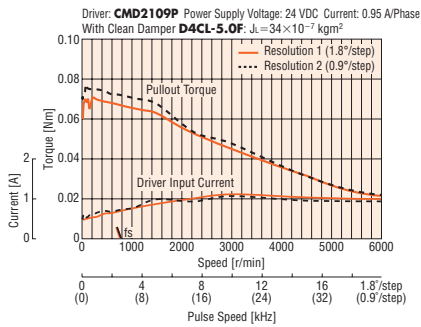

PKP225U09A2/ PKP225U09B2

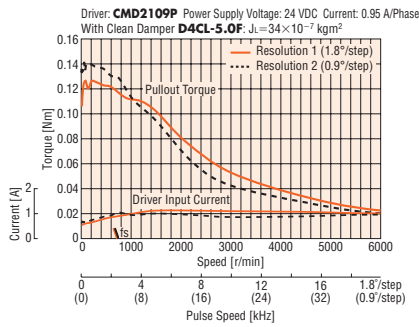

Note

● Data for the speed – torque characteristics is based on Oriental Motor's internal measurement conditions. If the conditions are changed, the characteristics may also change as a result.

● If there is a "clean damper" entry in the speed – torque characteristics, the data is for a double shaft motor when a clean damper is equipped.

● Depending on the driving conditions, a considerable amount of heat may be generated by the motor. Be sure to keep the motor case temperature at 100°C max.

Dimensions (Unit: mm)

Motor

Product Name	L1	L2	Mass [kg]
PKP223U09A2	32	–	0.11
PKP223U09B2		42	
PKP225U09A2	51.5	–	0.2
PKP225U09B2		61.5	

Applicable Connector

Connector Housing: 51065-0600 (Molex)

Contact: 50212-8100 (Molex)

Crimp Tool: 57176-5000 (Molex)

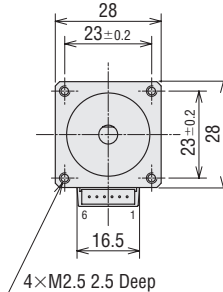
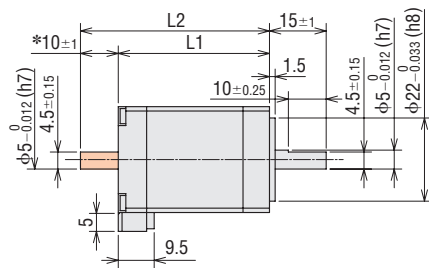

*The length of the shaft flat on the double shaft model is 10±0.25.

● These dimensions are for double shaft motors.

For single shaft motors, ignore the shaded areas.

Connection Cable (Sold separately)

Motor Connection Cable

Product Name	Length L [m]
LC2U06A	0.6
LC2U10A	1

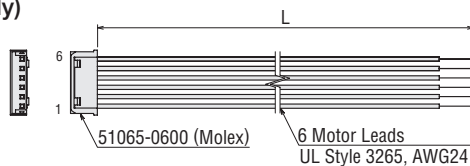

Inner Wiring Diagram of Motor

Wiring Diagram No.: Model B④

● See "Inner Wiring Diagram of Motor" page for the inner wiring diagram of the motor.

2-Phase Motors
PKP

Features Product Line

Product Number Product Line

Standard Type

High-Resolution Type

Flat Type

SH Geared Type

CS Geared Type

Common Specifications

Inner Wiring of Motor

5-Phase Motors
PKP

Features Product Line

Product Number Product Line

Standard Type

High-Resolution Type

TS Geared Type

Common Specifications

Motor Pin Arrangement

Drivers for 2-Phase/5-Phase Motors

Peripheral Equipment

Standard Type with Encoder Frame Size 28 mm (Bipolar 4 lead wires)

Connector Type

Specifications

Product Name	Maximum Holding Torque [Nm]	Rotor Inertia J: kgm ²	Rated Current A/Phase	Voltage VDC	Winding Resistance Ω/Phase	Inductance mH/Phase	Basic Step Angle	Recommended Driver Product Name*
PKP223D15A2-R2EL	0.095	9.1×10 ⁻⁷	1.5	1.77	1.18	0.96	1.8°	CVD215BR-K
PKP225D15A2-R2EL	0.19	18×10 ⁻⁷		3	2	1.6		

● See "Common Specifications" page for encoder specifications.

*See "Drivers for 2-Phase / 5-Phase Motors" page for drivers that can be used in combination.

Note

● Be sure to set the driver current at or below the motor rated current. If the motor rated current is exceeded, the product will be damaged.

Speed – Torque Characteristics (Reference values) fs: Max. Starting Frequency

PKP223D15A2-R2EL

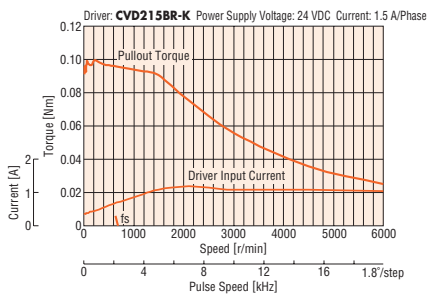

PKP225D15A2-R2EL

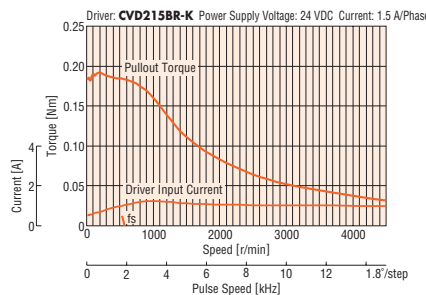

Note

● Data for the speed – torque characteristics is based on Oriental Motor's internal measurement conditions. If the conditions are changed, the characteristics may also change as a result.

● Depending on the driving conditions, a considerable amount of heat may be generated by the motor. To protect the encoder, be sure to keep the motor case temperature at 85°C max.

● The characteristics are the same when RS-485 communication type driver is used in combination.

Dimensions (Unit: mm)

● Motor

Product Name	L	Mass [kg]
PKP223D15A2-R2EL	47.5	0.12
PKP225D15A2-R2EL	67	0.21

● Either **E** (200 P/R) or **F** (400 P/R) indicating the encoder resolution is entered where the box is located within the product name.

● Applicable Connector (Molex)

	Motor	Encoder
Connector Housing	51065-0600	51021-0800
Contact	50212-8100	50079-8100
Crimping Tool	57176-5000	57177-5000

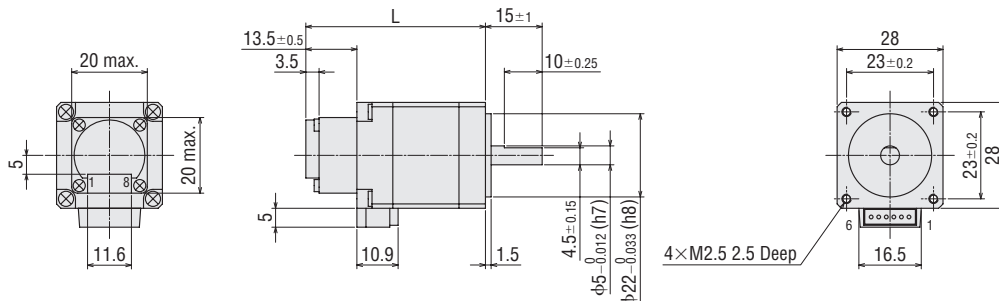

Inner Wiring Diagram of Motor

Wiring Diagram No.: Model B③

● See "Inner Wiring Diagram of Motor" page for the inner wiring diagram of the motor.

● Connection Cable (Sold separately)

◇ Motor Connection Cable

Product Name	Length L [m]
LC2B06A	0.6
LC2B10A	1

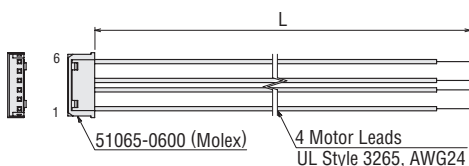

◇ Encoder Connection Cable

Product Name	Length L [m]
LCE08A-006	0.6

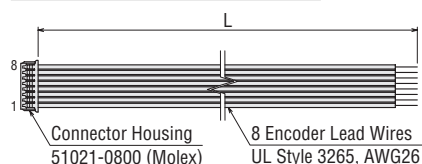

Standard Type with Encoder Frame Size 28 mm (Unipolar 6 lead wires) Connector Type

2-Phase
Motors
PKP

Features
Product
Line

Product
Number
Product Line

Standard
Type

High-
Resolution
Type

Flat
Type

SH Geared
Type

CS Geared
Type

Common
Specifications

Inner
Wiring
of Motor

5-Phase
Motors
PKP

Features
Product
Line

Product
Number
Product Line

Standard
Type

High-
Resolution
Type

TS Geared
Type

Common
Specifications

Motor
Pin
Arrangement

Drivers for
2-Phase/5-Phase
Motors

Peripheral
Equipment

Specifications

Product Name	Maximum Holding Torque [Nm]	Rotor Inertia J: kgm ²	Rated Current A/Phase	Voltage VDC	Winding Resistance Ω/Phase	Inductance mH/Phase	Basic Step Angle
PKP223U09A2-R2EL	0.075	9.1 × 10 ⁻⁷	0.95	2.95	3.11	1.44	1.8°
PKP225U09A2-R2EL	0.135	18 × 10 ⁻⁷		4.4	4.6	2.11	

● See "Common Specifications" page for encoder specifications.

*See "Drivers for 2-Phase / 5-Phase Motors" page for details on the recommended drivers.

Note

● Be sure to set the driver current at or below the motor rated current. If the motor rated current is exceeded, the product will be damaged.

Speed – Torque Characteristics (Reference values) fs: Max. Starting Frequency

PKP223U09A2-R2EL

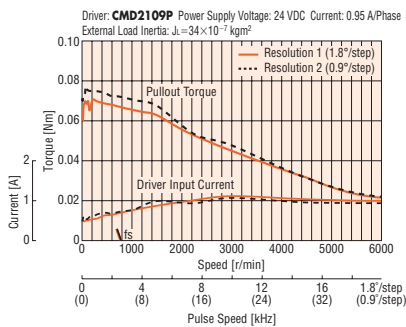

PKP225U09A2-R2EL

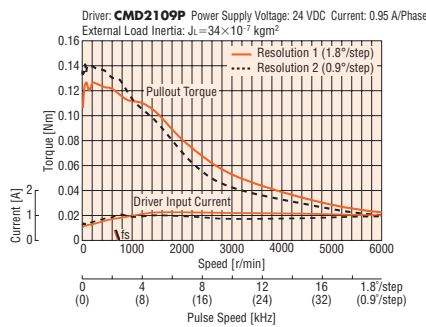

Note

● Data for the speed – torque characteristics is based on Oriental Motor's internal measurement conditions. If the conditions are changed, the characteristics may also change as a result.

● The data in the speed – torque characteristics represents the use of an external load inertia.

● Depending on the driving conditions, a considerable amount of heat may be generated by the motor. To protect the encoder, be sure to keep the motor case temperature at 85°C max.

Dimensions (Unit: mm)

Motor

Product Name	L	Mass [kg]
PKP223U09A2-R2EL	47.5	0.12
PKP225U09A2-R2EL	67	0.21

● Either **E** (200 P/R) or **F** (400 P/R) indicating the encoder resolution is entered where the box □ is located within the product name.

● Applicable Connector (Molex)

	Motor	Encoder
Connector Housing	51065-0600	51021-0800
Contact	50212-8100	50079-8100
Crimping Tool	57176-5000	57177-5000

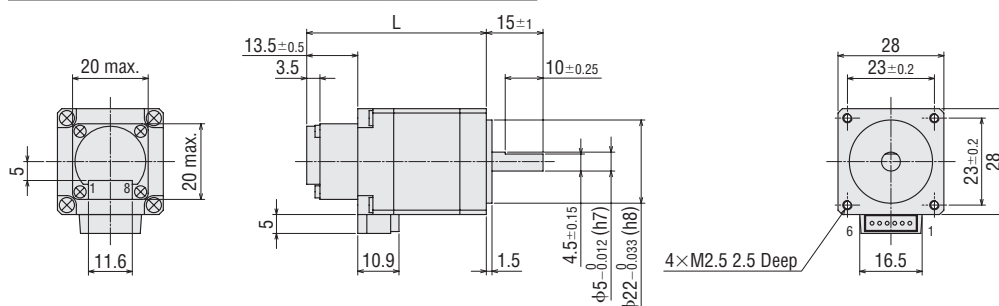

Inner Wiring Diagram of Motor

Wiring Diagram No.: Model B④

● See "Inner Wiring Diagram of Motor" page for the inner wiring diagram of the motor.

Connection Cable (Sold separately)

Motor Connection Cable

Product Name	Length L [m]
LC2U06A	0.6
LC2U10A	1

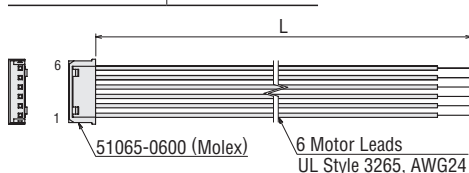

Encoder Connection Cable

Product Name	Length L [m]
LCE08A-006	0.6

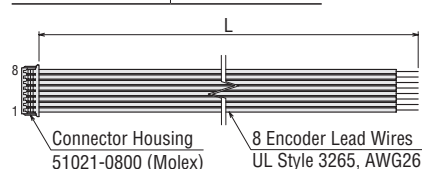

Standard Type with Electromagnetic Brake Frame Size 28 mm (Bipolar 4 lead wires)

Connector Type

Specifications

Product Name	Maximum Holding Torque [Nm]	Rotor Inertia J: kgm ²	Rated Current A/Phase	Voltage VDC	Winding Resistance Ω/Phase	Inductance mH/Phase	Basic Step Angle	Electromagnetic Brake Static Friction Torque [Nm]
PKP223D15M2	0.095	14×10 ⁻⁷ *	1.5	1.77	1.18	0.96	1.8°	0.08
PKP225D15M2	0.19	23×10 ⁻⁷ *		3	2	1.6		

● Refer to the common specification page for electromagnetic brake specifications.

*This value is including the electromagnetic brake inertia.

Note

● Be sure to set the driver current at or below the motor rated current. If the motor rated current is exceeded, the product will be damaged.

Speed – Torque Characteristics (Reference values) fs: Max. Starting Frequency

PKP223D15M2

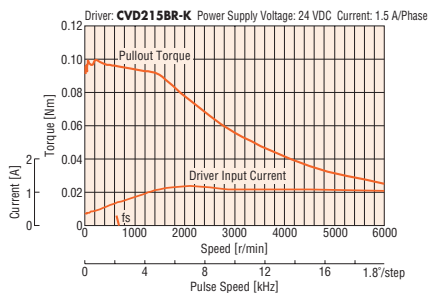

PKP225D15M2

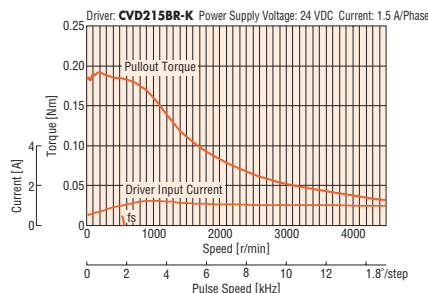

Note

- Data for the speed – torque characteristics is based on Oriental Motor's internal measurement conditions. If the conditions are changed, the characteristics may also change as a result.
- Depending on the driving conditions, a considerable amount of heat may be generated by the motor. Be sure to keep the motor case temperature at 100°C max.
- The characteristics are the same when RS-485 communication type driver is used in combination.

Dimensions (Unit: mm)

● Motor

Product Name	L	Mass [kg]
PKP223D15M2	65.5	0.17
PKP225D15M2	85	0.26

● Applicable Connector

Connector Housing: 51065-0600 (Molex)

Contact: 50212-8100 (Molex)

Crimp Tool: 57176-5000 (Molex)

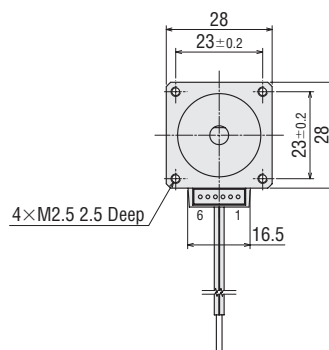
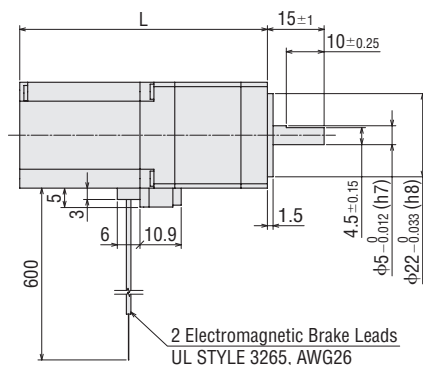

Inner Wiring Diagram of Motor

Wiring Diagram No.: Model B③

● See "Inner Wiring Diagram of Motor" page for the inner wiring diagram of the motor.

● Connection Cable (Sold separately)

◇ Motor Connection Cable

Product Name	Length L [m]
LC2B06A	0.6
LC2B10A	1

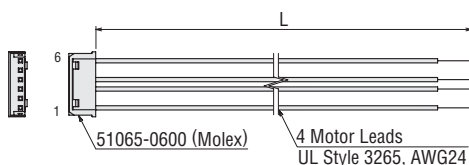

Standard Type with Electromagnetic Brake Frame Size 28 mm (Unipolar 6 lead wires) Connector Type

2-Phase Motors
PKP

Features Product Line

Product Number Product Line

Standard Type

High-Resolution Type

Flat Type

SH Geared Type

CS Geared Type

Common Specifications

Inner Wiring of Motor

5-Phase Motors
PKP

Features Product Line

Product Number Product Line

Standard Type

High-Resolution Type

TS Geared Type

Common Specifications

Motor Pin Arrangement

Drivers for 2-Phase/5-Phase Motors

Peripheral Equipment

Specifications

Product Name	Maximum Holding Torque [Nm]	Rotor Inertia J: kgm ²	Rated Current A/Phase	Voltage VDC	Winding Resistance Ω/Phase	Inductance mH/Phase	Basic Step Angle	Electromagnetic Brake Static Friction Torque [Nm]
PKP223U09M2	0.075	14×10 ⁻⁷ *	0.95	2.95	3.11	1.44	1.8°	0.08
PKP225U09M2	0.135	23×10 ⁻⁷ *		4.4	4.6	2.11		

● Refer to the common specification page for electromagnetic brake specifications.

* This value is including the electromagnetic brake inertia.

Note

● Be sure to set the driver current at or below the motor rated current. If the motor rated current is exceeded, the product will be damaged.

Speed – Torque Characteristics (Reference values) fs: Max. Starting Frequency

PKP223U09M2

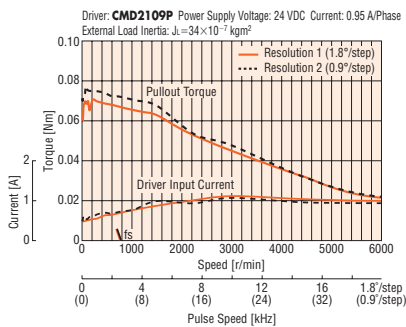

PKP225U09M2

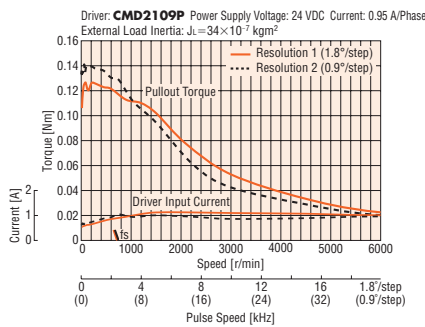

Note

● Data for the speed – torque characteristics is based on Oriental Motor's internal measurement conditions. If the conditions are changed, the characteristics may also change as a result.

● The data in the speed – torque characteristics represents the use of an external load inertia.

● Depending on the driving conditions, a considerable amount of heat may be generated by the motor. Be sure to keep the motor case temperature at 100°C max.

Dimensions (Unit: mm)

Motor

Product Name	L	Mass [kg]
PKP223U09M2	65.5	0.17
PKP225U09M2	85	0.26

Applicable Connector

Connector Housing: 51065-0600 (Molex)

Contact: 50212-8100 (Molex)

Crimp Tool: 57176-5000 (Molex)

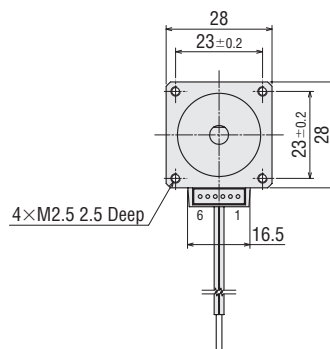
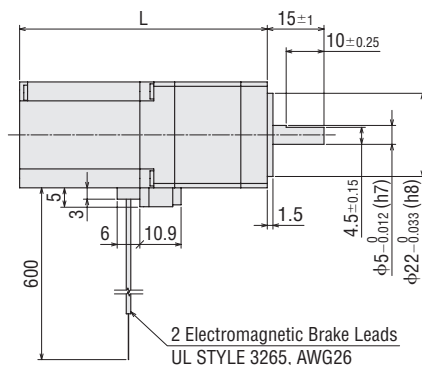

Inner Wiring Diagram of Motor

Wiring Diagram No.: Model B④

● See "Inner Wiring Diagram of Motor" page for the inner wiring diagram of the motor.

Connection Cable (Sold separately)

Motor Connection Cable

Product Name	Length L [m]
LC2U06A	0.6
LC2U10A	1

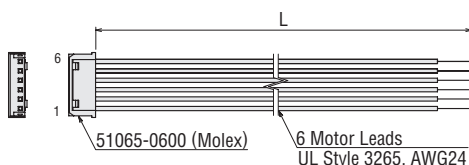

Standard Type Frame Size 35 mm (Bipolar 4 lead wires)

Connector Type

□13 mm

□20 mm

□28 mm

□35 mm

□42 mm

□50 mm

□51 mm

□56.4 mm

□60 mm

□61 mm

□85 mm

□90 mm

Specifications

Product Name	Maximum Holding Torque [Nm]	Rotor Inertia J: kgm ²	Rated Current A/Phase	Voltage VDC	Winding Resistance Ω/Phase	Inductance mH/Phase	Basic Step Angle	Recommended Driver Product Name*
PKP233D15□	0.2	24×10 ⁻⁷	1.5	2.43	1.62	1.5	1.8°	CVD215BR-K
PKP233D23□			2.3	1.56	0.68	0.67		CVD223BR-K
PKP235D15□	0.37	50×10 ⁻⁷	1.5	3.6	2.4	2.6		CVD215BR-K
PKP235D23□			2.3	2.23	0.97	1.2		CVD223BR-K

● The box □ in the product name indicates the shaft **A** (single shaft) or **B** (double shaft).

*See "Drivers for 2-Phase / 5-Phase Motors" page for drivers that can be used in combination.

Note

● Be sure to set the driver current at or below the motor rated current. If the motor rated current is exceeded, the product will be damaged.

Speed – Torque Characteristics (Reference values) fs: Max. Starting Frequency

PKP233D15A/PKP233D15B

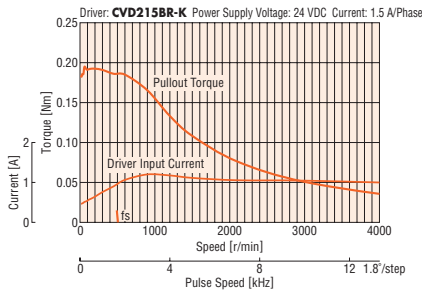

PKP235D15A/PKP235D15B

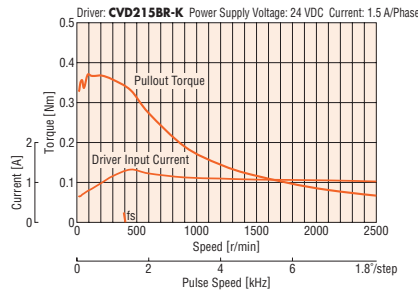

PKP233D23A/PKP233D23B

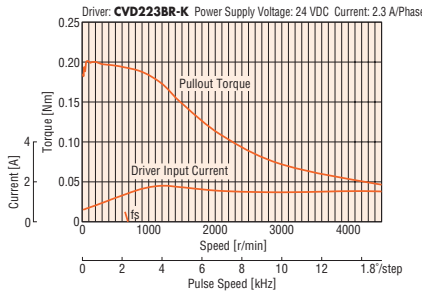

PKP235D23A/PKP235D23B

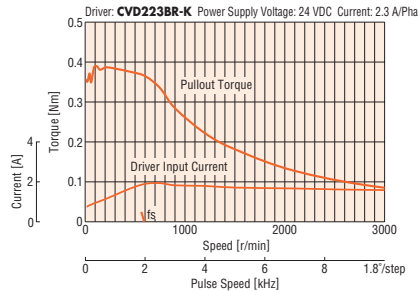

Note

- Data for the speed – torque characteristics is based on Oriental Motor's internal measurement conditions. If the conditions are changed, the characteristics may also change as a result.
- Depending on the driving conditions, a considerable amount of heat may be generated by the motor. Be sure to keep the motor case temperature at 100°C max.
- The characteristics are the same when RS-485 communication type driver is used in combination.

Dimensions (Unit: mm)

Motor

Product Name	L1	L2	Mass [kg]
PKP233D15A	37	—	0.18
PKP233D15B		52	
PKP233D23A		—	
PKP233D23B		52	
PKP235D15A	52	—	0.285
PKP235D15B		67	
PKP235D23A		—	
PKP235D23B		67	

Applicable Connector

Connector Housing: 51103-0600 (Molex)

Contact: 50351-8100 (Molex)

Crimp Tool: 57295-5000 (Molex)

Connection Cable (Sold separately)

Motor Connection Cable

Product Name	Length L [m]
LC2B06B	0.6
LC2B10B	1

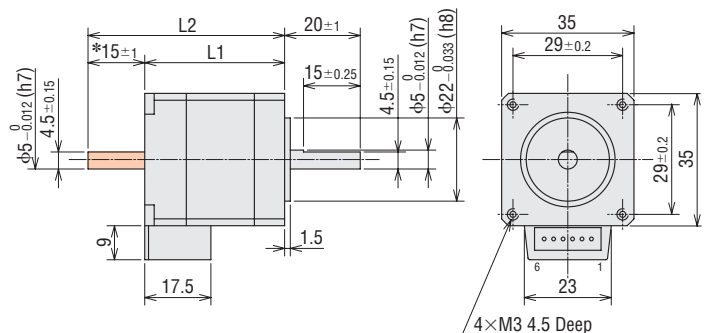
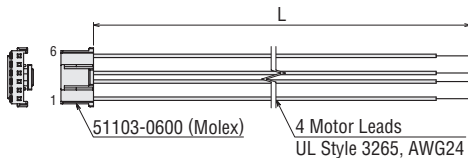

*The length of the shaft flat on the double shaft model is 15±0.25.

● These dimensions are for double shaft motors.

For single shaft motors, ignore the shaded areas.

Inner Wiring Diagram of Motor

Wiring Diagram No.: Model B③

● See "Inner Wiring Diagram of Motor" page for the inner wiring diagram of the motor.

Standard Type Frame Size 35 mm (Unipolar 6 lead wires)

Connector Type

Specifications

Product Name	Maximum Holding Torque [Nm]	Rotor Inertia J: kgm ²	Rated Current A/Phase	Voltage VDC	Winding Resistance Ω/Phase	Inductance mH/Phase	Basic Step Angle
PKP233U12□	0.16	24×10 ⁻⁷	1.2	3.24	2.7	1.4	1.8°
PKP235U12□	0.3	50×10 ⁻⁷		4.08	3.4	2	

● The box □ in the product name indicates the shaft **A** (single shaft) or **B** (double shaft).
 *See "Drivers for 2-Phase / 5-Phase Motors" page for details on the recommended drivers.

Note

● Be sure to set the driver current at or below the motor rated current. If the motor rated current is exceeded, the product will be damaged.

Speed – Torque Characteristics (Reference values) fs: Max. Starting Frequency

PKP233U12A/PKP233U12B

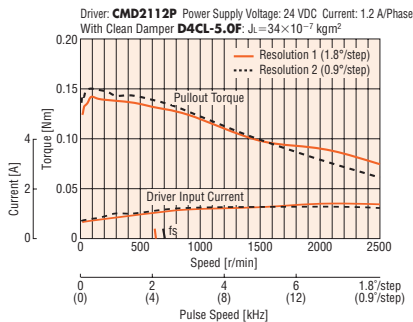

PKP235U12A/PKP235U12B

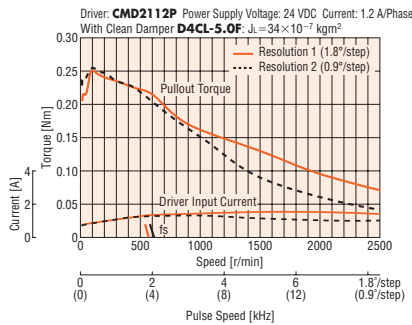

Note

● Data for the speed – torque characteristics is based on Oriental Motor's internal measurement conditions. If the conditions are changed, the characteristics may also change as a result.
 ● If there is a "clean damper" entry in the speed – torque characteristics, the data is for a double shaft motor when a clean damper is equipped.
 ● Depending on the driving conditions, a considerable amount of heat may be generated by the motor. Be sure to keep the motor case temperature at 100°C max.

Dimensions (Unit: mm)

Motor

Product Name	L1	L2	Mass [kg]
PKP233U12A	37	—	0.18
PKP233U12B		52	
PKP235U12A	52	—	0.285
PKP235U12B		67	

● Applicable Connector
 Connector Housing: 51103-0600 (Molex)
 Contact: 50351-8100 (Molex)
 Crimp Tool: 57295-5000 (Molex)

Connection Cable (Sold separately)

Motor Connection Cable

Product Name	Length L [m]
LC2U06B	0.6
LC2U10B	1

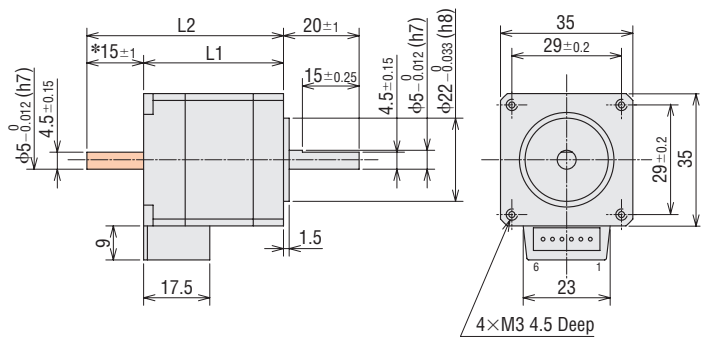
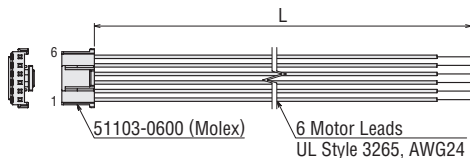

*The length of the shaft flat on the double shaft model is 15±0.25.
 ● These dimensions are for double shaft motors.
 For single shaft motors, ignore the shaded areas.

Inner Wiring Diagram of Motor

Wiring Diagram No.: Model B④

● See "Inner Wiring Diagram of Motor" page for the inner wiring diagram of the motor.

2-Phase Motors
PKP

Features Product Line

Product Number Product Line

Standard Type

High-Resolution Type

Flat Type

SH Geared Type

CS Geared Type

Common Specifications

Inner Wiring of Motor

5-Phase Motors
PKP

Features Product Line

Product Number Product Line

Standard Type

High-Resolution Type

TS Geared Type

Common Specifications

Motor Pin Arrangement

Drivers for 2-Phase/5-Phase Motors

Peripheral Equipment

Standard Type with Encoder Frame Size 35 mm (Bipolar 4 lead wires)

Connector Type

Specifications

Product Name	Maximum Holding Torque [Nm]	Rotor Inertia J: kgm ²	Rated Current A/Phase	Voltage VDC	Winding Resistance Ω/Phase	Inductance mH/Phase	Basic Step Angle	Recommended Driver Product Name*
PKP233D15A-R2EL	0.2	24×10 ⁻⁷	1.5	2.43	1.62	1.5	1.8°	CVD215BR-K
PKP235D15A-R2EL	0.37	50×10 ⁻⁷	1.5	3.6	2.4	2.6		CVD215BR-K

● See "Common Specifications" page for encoder specifications.

*See "Drivers for 2-Phase / 5-Phase Motors" page for drivers that can be used in combination.

Note

● Be sure to set the driver current at or below the motor rated current. If the motor rated current is exceeded, the product will be damaged.

Speed – Torque Characteristics (Reference values) fs: Max. Starting Frequency

PKP233D15A-R2EL

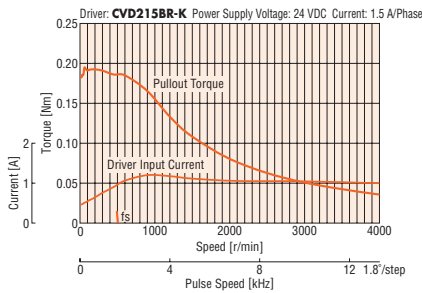

PKP235D15A-R2EL

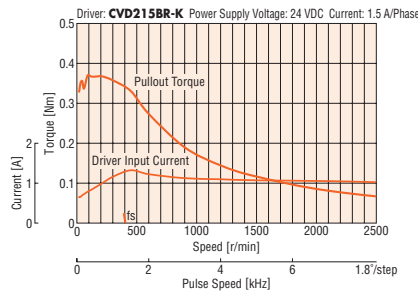

Note

- Data for the speed – torque characteristics is based on Oriental Motor's internal measurement conditions. If the conditions are changed, the characteristics may also change as a result.
- Depending on the driving conditions, a considerable amount of heat may be generated by the motor. To protect the encoder, be sure to keep the motor case temperature at 85°C max.
- The characteristics are the same when RS-485 communication type driver is used in combination.

Dimensions (Unit: mm)

Motor

Product Name	L	Mass [kg]
PKP233D15A-R2EL	50.5	0.19
PKP235D15A-R2EL	65.5	0.295

● Either **E** (200 P/R) or **F** (400 P/R) indicating the encoder resolution is entered where the box □ is located within the product name.

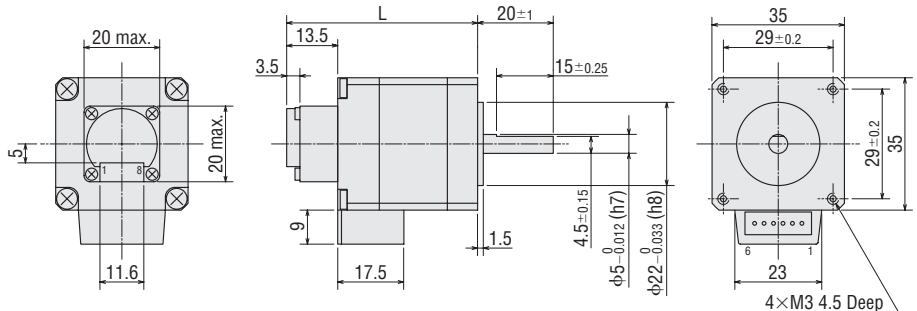

● Applicable Connector (Molex)

	Motor	Encoder
Connector Housing	51103-0600	51021-0800
Contact	50351-8100	50079-8100
Crimping Tool	57295-5000	57177-5000

Connection Cable (Sold separately)

◇ Motor Connection Cable

Product Name	Length L [m]
LC2B06B	0.6
LC2B10B	1

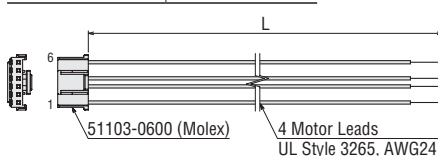

◇ Encoder Connection Cable

Product Name	Length L [m]
LCE08A-006	0.6

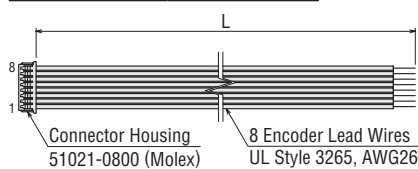

Inner Wiring Diagram of Motor

Wiring Diagram No.: Model B③

● See "Inner Wiring Diagram of Motor" page for the inner wiring diagram of the motor.

Standard Type with Encoder Frame Size 35 mm (Unipolar 6 lead wires) Connector Type

2-Phase
Motors
PKP

Features
Product
Line

Product
Number
Product Line

Standard
Type

High-
Resolution
Type

Flat
Type

SH Geared
Type

CS Geared
Type

Common
Specifications

Inner
Wiring
of Motor

5-Phase
Motors
PKP

Features
Product
Line

Product
Number
Product Line

Standard
Type

High-
Resolution
Type

TS Geared
Type

Common
Specifications

Motor
Pin
Arrangement

Drivers for
2-Phase/5-Phase
Motors

Peripheral
Equipment

Specifications

Product Name	Maximum Holding Torque [Nm]	Rotor Inertia J: kgm ²	Rated Current A/Phase	Voltage VDC	Winding Resistance Ω/Phase	Inductance mH/Phase	Basic Step Angle
PKP233U12A-R2EL	0.16	24 × 10 ⁻⁷	1.2	3.24	2.7	1.4	1.8°
PKP235U12A-R2EL	0.3	50 × 10 ⁻⁷		4.08	3.4	2	

● See "Common Specifications" page for encoder specifications.

*See "Drivers for 2-Phase / 5-Phase Motors" page for details on the recommended drivers.

Note

● Be sure to set the driver current at or below the motor rated current. If the motor rated current is exceeded, the product will be damaged.

Speed – Torque Characteristics (Reference values) fs: Max. Starting Frequency

PKP233U12A-R2EL

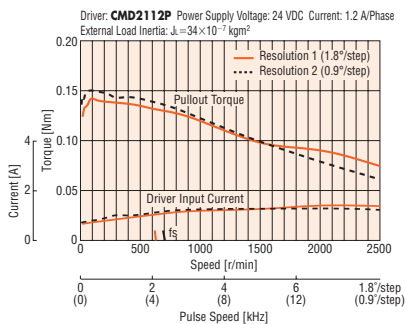

PKP235U12A-R2EL

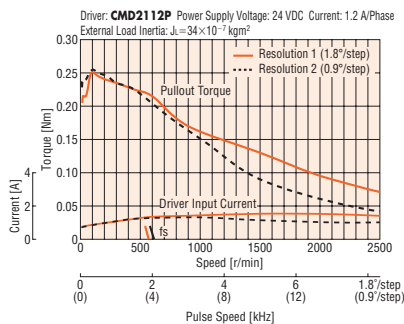

Note

● Data for the speed – torque characteristics is based on Oriental Motor's internal measurement conditions. If the conditions are changed, the characteristics may also change as a result.

● The data in the speed – torque characteristics represents the use of an external load inertia.

● Depending on the driving conditions, a considerable amount of heat may be generated by the motor. To protect the encoder, be sure to keep the motor case temperature at 85°C max.

Dimensions (Unit: mm)

Motor

Product Name	L	Mass [kg]
PKP233U12A-R2EL	50.5	0.19
PKP235U12A-R2EL	65.5	0.295

● Either **E** (200 P/R) or **F** (400 P/R) indicating the encoder resolution is entered where the box □ is located within the product name.

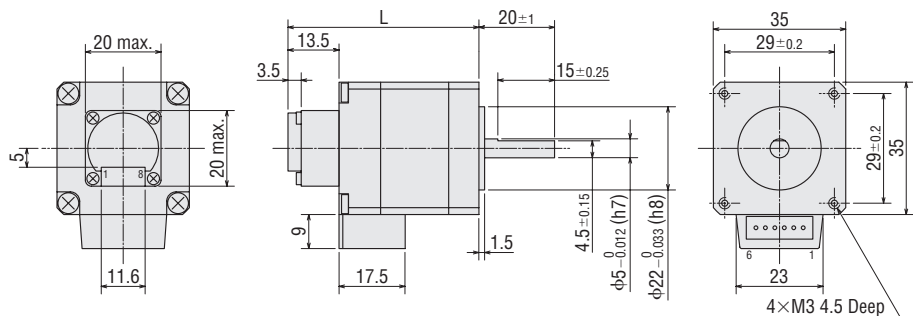

● Applicable Connector (Molex)

	Motor	Encoder
Connector Housing	51103-0600	51021-0800
Contact	50351-8100	50079-8100
Crimping Tool	57295-5000	57177-5000

Connection Cable (Sold separately)

Motor Connection Cable

Product Name	Length L [m]
LC2U06B	0.6
LC2U10B	1

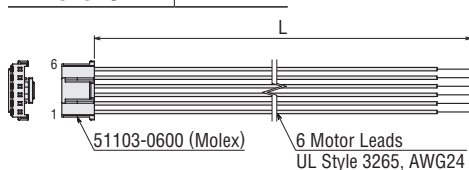

Encoder Connection Cable

Product Name	Length L [m]
LC08A-006	0.6

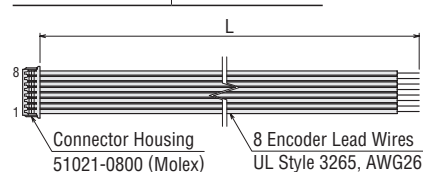

Inner Wiring Diagram of Motor

Wiring Diagram No.: Model B④

● See "Inner Wiring Diagram of Motor" page for the inner wiring diagram of the motor.

Standard Type with Electromagnetic Brake Frame Size 35 mm (Bipolar 4 lead wires)

Connector Type

13 mm

20 mm

28 mm

35 mm

42 mm

50 mm

51 mm

56.4 mm

60 mm

61 mm

85 mm

90 mm

Specifications

Product Name	Maximum Holding Torque [Nm]	Rotor Inertia J: kgm ²	Rated Current A/Phase	Voltage VDC	Winding Resistance Ω/Phase	Inductance mH/Phase	Basic Step Angle	Electromagnetic Brake Static Friction Torque [Nm]
PKP233D15M	0.2	36×10 ⁻⁷ *	1.5	2.43	1.62	1.5	1.8°	0.3
PKP235D15M	0.37	62×10 ⁻⁷ *		3.6	2.4	2.6		

● Refer to the common specification page for electromagnetic brake specifications.

* This value is including the electromagnetic brake inertia.

Note

● Be sure to set the driver current at or below the motor rated current. If the motor rated current is exceeded, the product will be damaged.

Speed – Torque Characteristics (Reference values) fs: Max. Starting Frequency

PKP233D15M

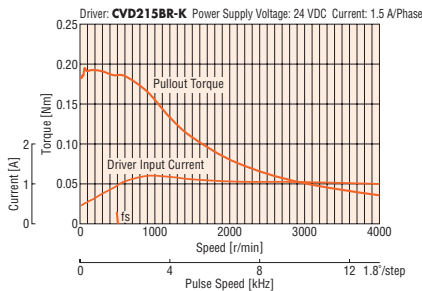

PKP235D15M

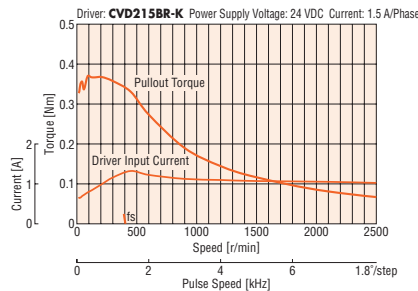

Note

● Data for the speed – torque characteristics is based on Oriental Motor's internal measurement conditions. If the conditions are changed, the characteristics may also change as a result.

● Depending on the driving conditions, a considerable amount of heat may be generated by the motor. Be sure to keep the motor case temperature at 100°C max.

● The characteristics are the same when RS-485 communication type driver is used in combination.

Dimensions (Unit: mm)

Motor

Product Name	L	Mass [kg]
PKP233D15M	71	0.285
PKP235D15M	86	0.39

● Applicable Connector (Molex)

Connector Housing: 51103-0600

Contact: 50351-8100

Crimp Tool: 57295-5000

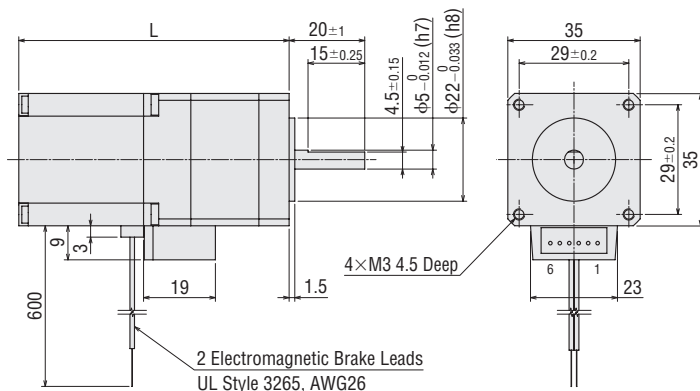

Inner Wiring Diagram of Motor

Wiring Diagram No.: Model B③

● See "Inner Wiring Diagram of Motor" page for the inner wiring diagram of the motor.

Connection Cable (Sold separately)

Motor Connection Cable

Product Name	Length L [m]
LC2B06B	0.6
LC2B10B	1

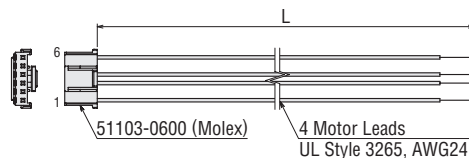

Standard Type with Electromagnetic Brake Frame Size 35 mm (Unipolar 6 lead wires) Connector Type

2-Phase
Motors
PKP

Features
Product
Line

Product
Number
Product Line

Standard
Type

High-
Resolution
Type

Flat
Type

SH Geared
Type

CS Geared
Type

Common
Specifications

Inner
Wiring
of Motor

5-Phase
Motors
PKP

Features
Product
Line

Product
Number
Product Line

Standard
Type

High-
Resolution
Type

TS Geared
Type

Common
Specifications

Motor
Pin
Arrangement

Drivers for
2-Phase/5-Phase
Motors

Peripheral
Equipment

Specifications

Product Name	Maximum Holding Torque [Nm]	Rotor Inertia J: kgm ²	Rated Current A/Phase	Voltage VDC	Winding Resistance Ω/Phase	Inductance mH/Phase	Basic Step Angle	Electromagnetic Brake Static Friction Torque [Nm]
PKP233U12M	0.16	36 × 10 ⁻⁷ *	1.2	3.24	2.7	1.4	1.8°	0.3
PKP235U12M	0.3	62 × 10 ⁻⁷ *		4.08	3.4	2		

● Refer to the common specification page for electromagnetic brake specifications.

*This value is including the electromagnetic brake inertia.

Note

● Be sure to set the driver current at or below the motor rated current. If the motor rated current is exceeded, the product will be damaged.

Speed – Torque Characteristics (Reference values) fs: Max. Starting Frequency

PKP233U12M

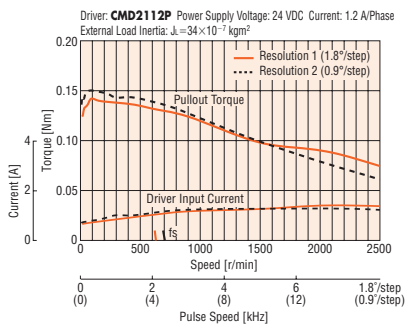

PKP235U12M

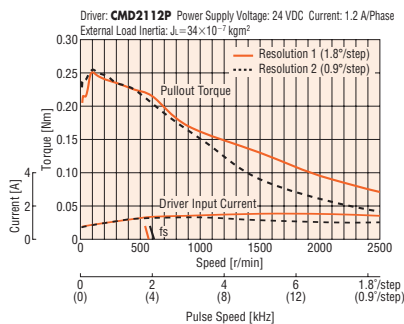

Note

● Data for the speed – torque characteristics is based on Oriental Motor's internal measurement conditions. If the conditions are changed, the characteristics may also change as a result.

● The data in the speed – torque characteristics represents the use of an external load inertia.

● Depending on the driving conditions, a considerable amount of heat may be generated by the motor. Be sure to keep the motor case temperature at 100°C max.

Dimensions (Unit: mm)

Motor

Product Name	L	Mass [kg]
PKP233U12M	71	0.285
PKP235U12M	86	0.39

● Applicable Connector (Molex)

Connector Housing: 51103-0600

Contact: 50351-8100

Crimp Tool: 57295-5000

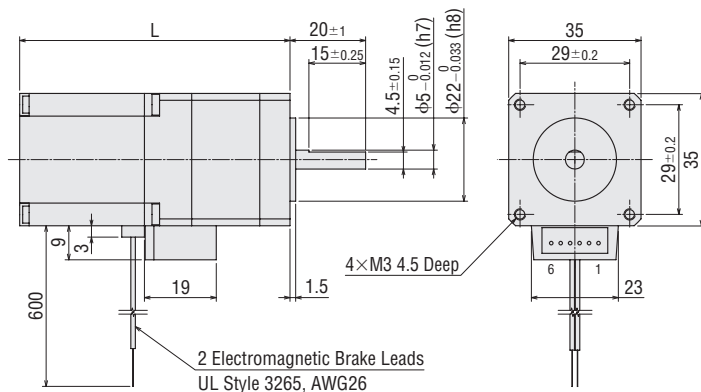

Inner Wiring Diagram of Motor

Wiring Diagram No.: Model B④

● See "Inner Wiring Diagram of Motor" page for the inner wiring diagram of the motor.

Connection Cable (Sold separately)

Motor Connection Cable

Product Name	Length L [m]
LC2U06B	0.6
LC2U10B	1

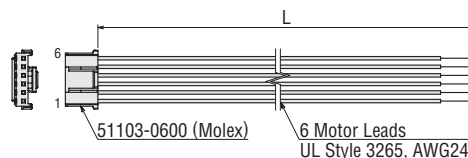

Standard Type Frame Size 42 mm (Bipolar 4 lead wires)

Mini-Connector Type

Specifications

Product Name	Maximum Holding Torque [Nm]	Rotor Inertia J: kgm ²	Rated Current A/Phase	Voltage VDC	Winding Resistance Ω/Phase	Inductance mH/Phase	Basic Step Angle	Recommended Driver Product Name*
PKP243D08□2	0.35	36×10 ⁻⁷	0.85	4.6	5.4	10	1.8°	CVD223FBR-K
PKP243D15□2			1.5	2.7	1.8	3.3		
PKP243D23□2			2.3	1.8	0.78	1.4		
PKP244D08□2	0.48	54×10 ⁻⁷	0.85	5.7	6.7	14		
PKP244D15□2			1.5	3.2	2.1	4.4		
PKP244D23□2			2.3	2.1	0.93	1.9		
PKP245D08□2	0.66	73×10 ⁻⁷	0.85	6	7.1	16		
PKP245D15□2			1.5	3.3	2.2	5.3		
PKP245D23□2			2.3	2.3	1	2.2		
PKP246D15□2	0.99	110×10 ⁻⁷	1.5	4.4	2.9	7.9		
PKP246D23□2			2.3	3.2	1.4	3.3		

● The box □ in the product name indicates the shaft **A** (single shaft) or **B** (double shaft).

*See "Drivers for 2-Phase / 5-Phase Motors" page for drivers that can be used in combination.

[Note]

● Be sure to set the driver current at or below the motor rated current. If the motor rated current is exceeded, the product will be damaged.

Speed – Torque Characteristics (Reference values) fs: Max. Starting Frequency

PKP243D08A2/ PKP243D08B2

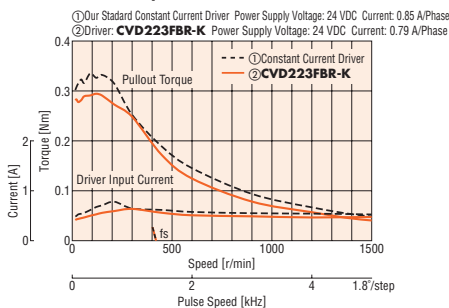

PKP243D15A2/ PKP243D15B2

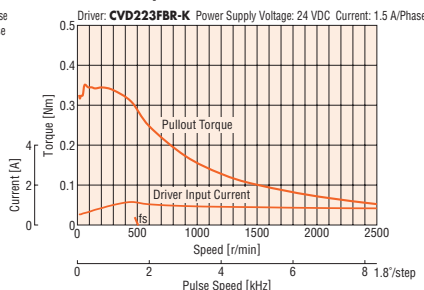

PKP243D23A2/ PKP243D23B2

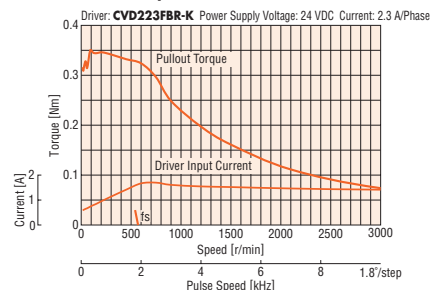

PKP244D08A2/ PKP244D08B2

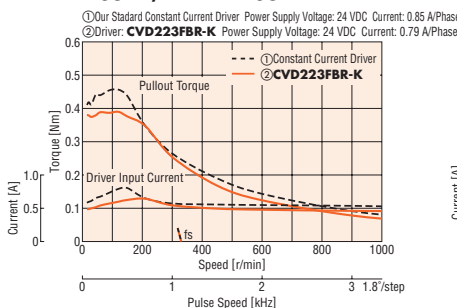

PKP244D15A2/ PKP244D15B2

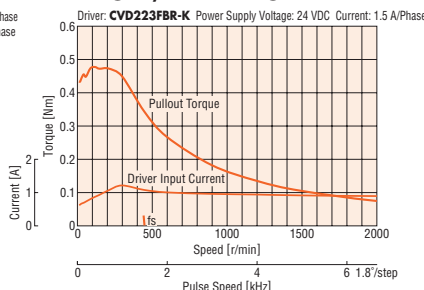

PKP244D23A2/ PKP244D23B2

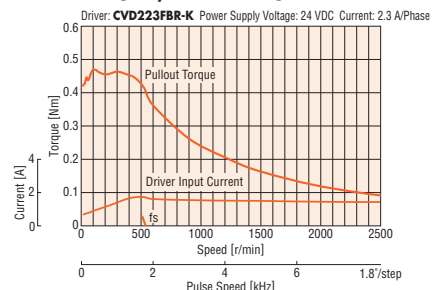

PKP245D08A2/ PKP245D08B2

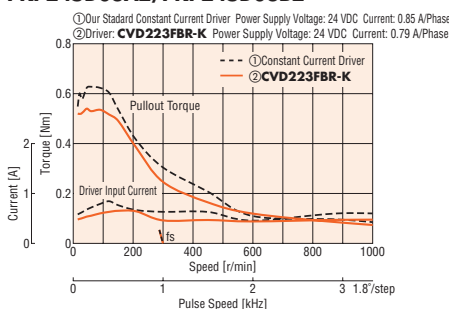

PKP245D15A2/ PKP245D15B2

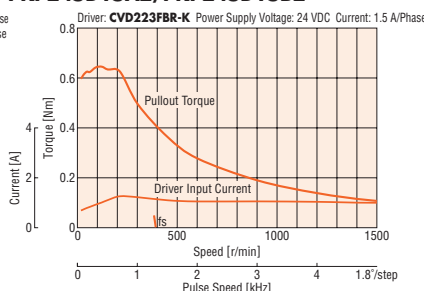

PKP245D23A2/ PKP245D23B2

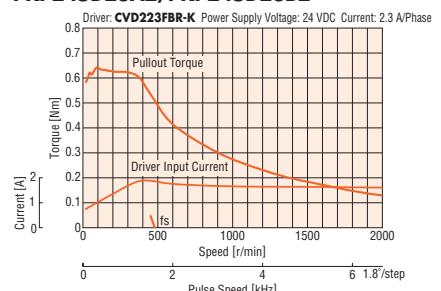

PKP246D15A2/ PKP246D15B2

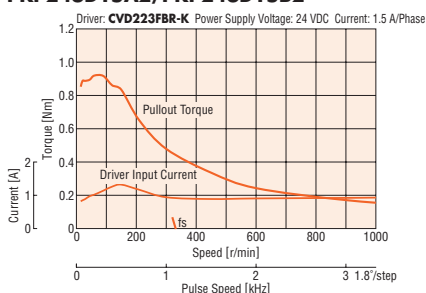

PKP246D23A2/ PKP246D23B2

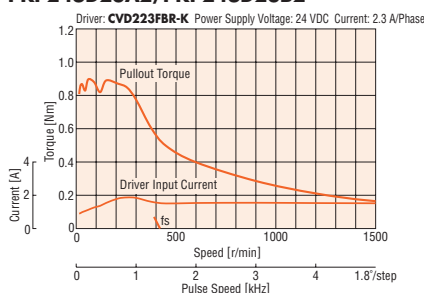

[Note]

● Data for the speed – torque characteristics is based on Oriental Motor's internal measurement conditions. If the conditions are changed, the characteristics may also change as a result.

● Depending on the driving conditions, a considerable amount of heat may be generated by the motor. Be sure to keep the motor case temperature at 100°C max.

● The characteristics are the same when RS-485 communication type driver is used in combination.

Dimensions (Unit: mm)

● Motor

Product Name	L1	L2	Mass [kg]
PKP243D08A2	33	—	0.23
PKP243D08B2		48	
PKP243D15A2		—	
PKP243D15B2		48	
PKP243D23A2		—	
PKP243D23B2	48	—	
PKP244D08A2	39	—	0.3
PKP244D08B2		54	
PKP244D15A2		—	
PKP244D15B2		54	
PKP244D23A2		—	
PKP244D23B2	54	—	
PKP245D08A2	47	—	0.37
PKP245D08B2		62	
PKP245D15A2		—	
PKP245D15B2		62	
PKP245D23A2		—	
PKP245D23B2	62	—	
PKP246D15A2	59	—	0.5
PKP246D15B2		74	
PKP246D23A2		—	
PKP246D23B2		74	

● Applicable Connector

Connector Housing: MDF97A-5S-3.5C (HIROSE ELECTRIC CO., LTD.)

Contact: MDF97-22SC (HIROSE ELECTRIC CO., LTD.)

Crimp Tool: HT801/MDF97-22S (HIROSE ELECTRIC CO., LTD.)

● Connection Cable (Sold separately)

◇ Motor Connection Cable

Product Name	Length L [m]
LC2B06E	0.6
LC2B10E	1

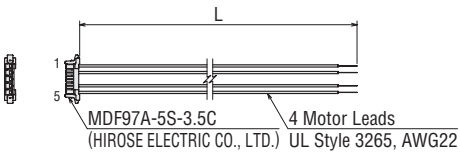

Inner Wiring Diagram of Motor

Wiring Diagram No.: Model A①

● See "Inner Wiring Diagram of Motor" page for the inner wiring diagram of the motor.

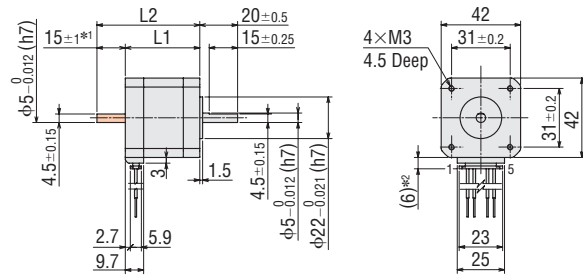

*1 The length of the shaft flat on the double shaft model is 15 ± 0.25 .

*2 With connection cable

● These dimensions are for double shaft motors.

For single shaft motors, ignore the shaded areas.

2-Phase
Motors
PKP

Features
Product
Line

Product
Number
Product Line

Standard
Type

High-
Resolution
Type

Flat
Type

SH Geared
Type

CS Geared
Type

Common
Specifications

Inner
Wiring
of Motor

5-Phase
Motors
PKP

Features
Product
Line

Product
Number
Product Line

Standard
Type

High-
Resolution
Type

TS Geared
Type

Common
Specifications

Motor
Pin
Arrangement

Drivers for
2-Phase/5-Phase
Motors

Peripheral
Equipment

Standard Type Frame Size 42 mm (Bipolar 4 lead wires)

Connector Type

Specifications

Product Name	Maximum Holding Torque [Nm]	Rotor Inertia J: kgm ²	Rated Current A/Phase	Voltage VDC	Winding Resistance Ω/Phase	Inductance mH/Phase	Basic Step Angle	Recommended Driver Product Name*
PKP243D15□	0.35	36×10 ⁻⁷	1.5	2.85	1.9	5	1.8°	CVD215BR-K
PKP243D23□			2.3	1.93	0.84	2.1		CVD223BR-K
PKP244D15□	0.48	57×10 ⁻⁷	1.5	3.9	2.6	4.9		CVD215BR-K
PKP244D23□			2.3	2.34	1.02	2.1		CVD223BR-K
PKP245D15□	0.58	83×10 ⁻⁷	1.5	3.6	2.4	6.6		CVD215BR-K
PKP245D23□			2.3	2.57	1.12	2.9		CVD223BR-K
PKP246D15□	0.93	114×10 ⁻⁷	1.5	5.8	3.87	8		CVD215BR-K
PKP246D23□			2.3	3.45	1.5	3.5		CVD223BR-K

● The box □ in the product name indicates the shaft **A** (single shaft) or **B** (double shaft).

*See "Drivers for 2-Phase / 5-Phase Motors" page for drivers that can be used in combination.

Note

● Be sure to set the driver current at or below the motor rated current. If the motor rated current is exceeded, the product will be damaged.

Speed – Torque Characteristics (Reference values) fs: Max. Starting Frequency

PKP243D15A/ PKP243D15B

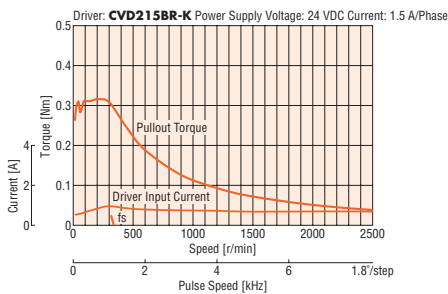

PKP243D23A/ PKP243D23B

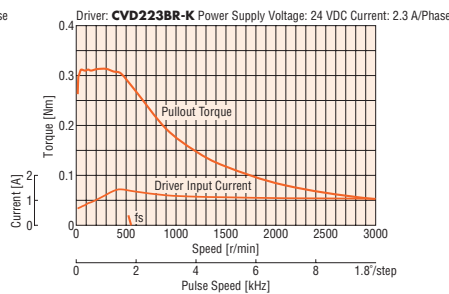

PKP244D15A/ PKP244D15B

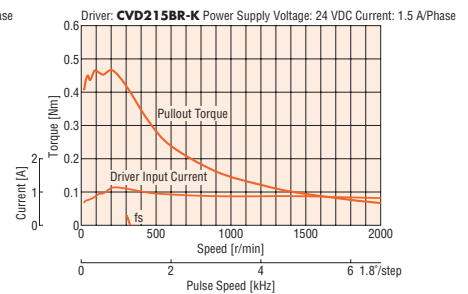

PKP244D23A/ PKP244D23B

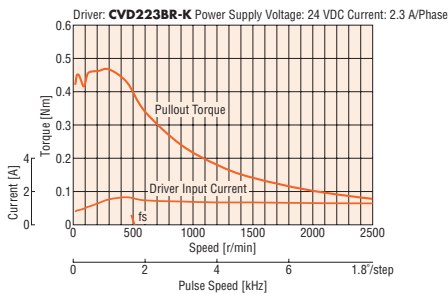

PKP245D15A/ PKP245D15B

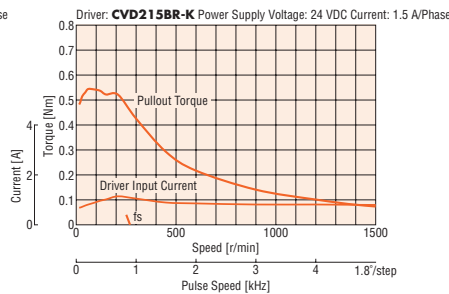

PKP245D23A/ PKP245D23B

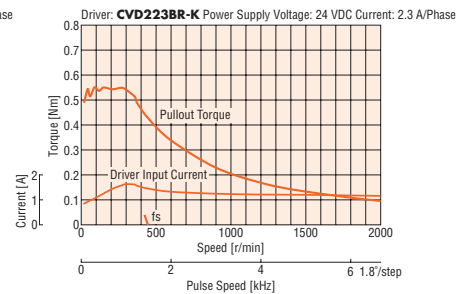

PKP246D15A/ PKP246D15B

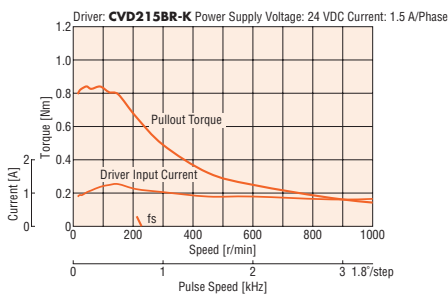

PKP246D23A/ PKP246D23B

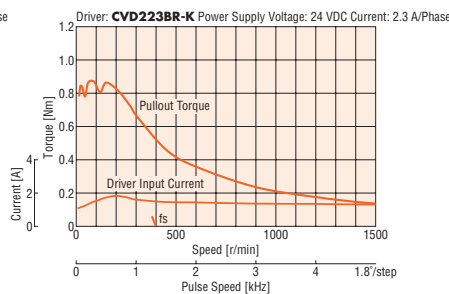

Note

- Data for the speed – torque characteristics is based on Oriental Motor's internal measurement conditions. If the conditions are changed, the characteristics may also change as a result.
- Depending on the driving conditions, a considerable amount of heat may be generated by the motor. Be sure to keep the motor case temperature at 100°C or less.
- The characteristics are the same if combined with an RS-485 communication type driver.

Dimensions (Unit: mm)

Motor

Product Name	L1	L2	Mass [kg]
PKP243D15A	33	—	0.25
PKP243D15B		48	
PKP243D23A		—	
PKP243D23B		48	
PKP244D15A	39	—	0.3
PKP244D15B		54	
PKP244D23A		—	
PKP244D23B		54	
PKP245D15A	47	—	0.39
PKP245D15B		62	
PKP245D23A		—	
PKP245D23B		62	
PKP246D15A	59	—	0.5
PKP246D15B		74	
PKP246D23A		—	
PKP246D23B		74	

- Applicable Connector (Molex)
Connector Housing: 51103-0600 (Molex)
Contact: 50351-8100 (Molex)
Crimp Tool: 57295-5000 (Molex)

Connection Cable (Sold separately)

Motor Connection Cable

Product Name	Length L [m]
LC2B06B	0.6
LC2B10B	1

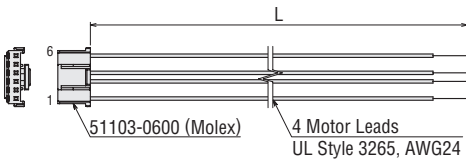

Inner Wiring Diagram of Motor

Wiring Diagram No.: Model B③

- Refer to the motor inner wiring page for an inner wiring diagram of the motor.

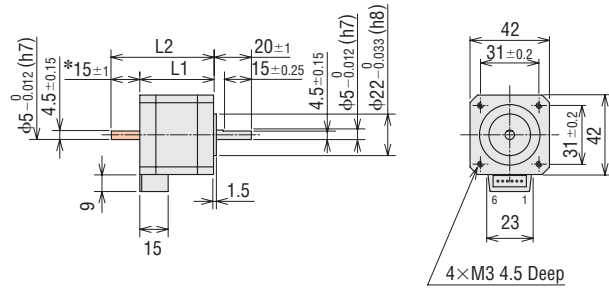

*The length of the shaft flat on the double shaft model is 15 ± 0.25 .

- These dimensions are for double shaft motors.

For single shaft motors, ignore the shaded areas.

2-Phase
Motors
PKP

Features
Product
Line

Product
Number
Product Line

Standard
Type

High-
Resolution
Type

Flat
Type

SH Geared
Type

CS Geared
Type

Common
Specifications

Inner
Wiring
of Motor

5-Phase
Motors
PKP

Features
Product
Line

Product
Number
Product Line

Standard
Type

High-
Resolution
Type

TS Geared
Type

Common
Specifications

Motor
Pin
Arrangement

Drivers for
2-Phase/5-Phase
Motors

Peripheral
Equipment

Standard Type Frame Size 42 mm (Unipolar 5 lead wires)

Mini-Connector Type

13 mm

20 mm

28 mm

35 mm

42 mm

50 mm

51 mm

56.4 mm

60 mm

61 mm

85 mm

90 mm

Specifications

Product Name	Maximum Holding Torque [Nm]	Rotor Inertia J: kgm ²	Rated Current A/Phase	Voltage VDC	Winding Resistance Ω/Phase	Inductance mH/Phase	Basic Step Angle
PKP243U08□2	0.26	36×10 ⁻⁷	0.8	5.3	6.6	5.3	1.8°
PKP243U09□2			0.95	4.5	4.7	3.7	
PKP243U12□2			1.2	3.2	2.7	2.4	
PKP244U08□2	0.39	54×10 ⁻⁷	0.8	7.1	8.9	8.4	
PKP244U12□2			1.2	4.8	4	3.7	
PKP245U08□2	0.49	73×10 ⁻⁷	0.8	6.4	8	8.3	
PKP245U12□2			1.2	3.8	3.2	3.7	
PKP246U12□2	0.75	110×10 ⁻⁷	1.2	6.1	5.1	6	
PKP246U16□2			1.6	4.5	2.8	3.3	

● The box □ in the product name indicates the shaft **A** (single shaft) or **B** (double shaft).

*See "Drivers for 2-Phase / 5-Phase Motors" page for details on the recommended drivers.

Note

● Be sure to set the driver current at or below the motor rated current. If the motor rated current is exceeded, the product will be damaged.

Speed – Torque Characteristics (Reference values) fs: Max. Starting Frequency

PKP243U08A2/ PKP243U08B2

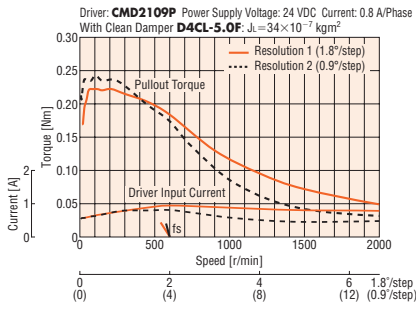

PKP243U09A2/ PKP243U09B2

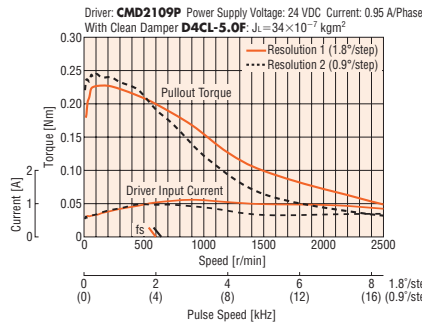

PKP243U12A2/ PKP243U12B2

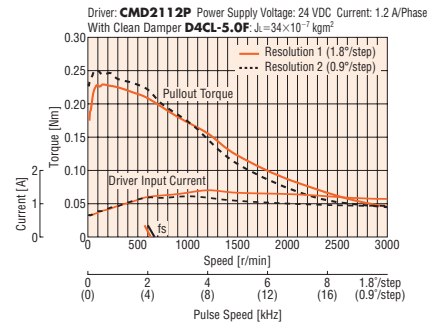

PKP244U08A2/ PKP244U08B2

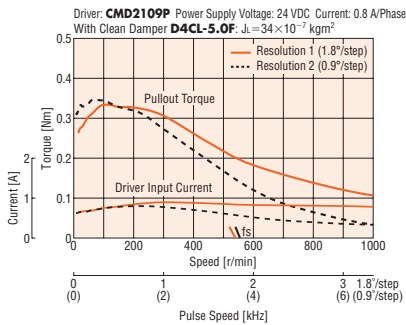

PKP244U12A2/ PKP244U12B2

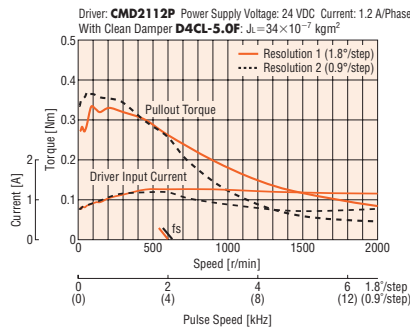

PKP245U08A2/ PKP245U08B2

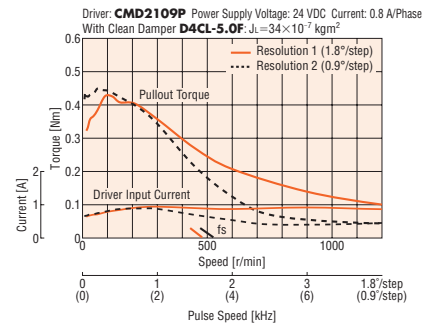

PKP245U12A2/ PKP245U12B2

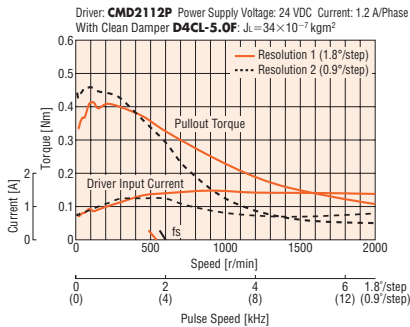

PKP246U12A2/ PKP246U12B2

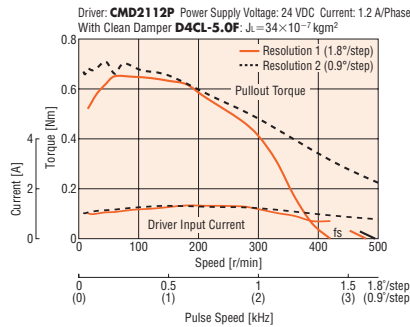

PKP246U16A2/ PKP246U16B2

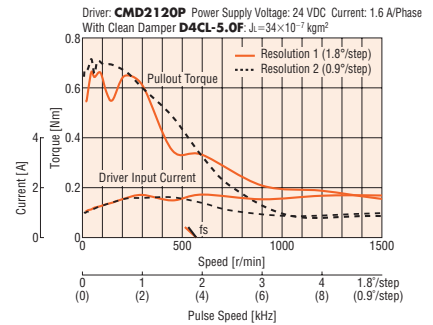

Note

● Data for the speed – torque characteristics is based on Oriental Motor's internal measurement conditions. If the conditions are changed, the characteristics may also change as a result.

● If there is a "clean damper" entry in the speed – torque characteristics, the data is for a double shaft motor when a clean damper is equipped.

● Depending on the driving conditions, a considerable amount of heat may be generated by the motor. Be sure to keep the motor case temperature at 100°C max.

Dimensions (Unit: mm)

● Motor

Product Name	L1	L2	Mass [kg]
PKP243U08A2	33	—	0.23
PKP243U08B2		48	
PKP243U09A2		—	
PKP243U09B2		48	
PKP243U12A2		—	
PKP243U12B2	48	0.3	
PKP244U08A2	39		—
PKP244U08B2			54
PKP244U12A2			—
PKP244U12B2			54
PKP245U08A2		47	—
PKP245U08B2	62		
PKP245U12A2	—		
PKP245U12B2	62		
PKP246U12A2	59		—
PKP246U12B2		74	
PKP246U16A2		—	
PKP246U16B2		74	

● Applicable Connector

Connector Housing: MDF97A-5S-3.5C (HIROSE ELECTRIC CO., LTD.)

Contact: MDF97-22SC (HIROSE ELECTRIC CO., LTD.)

Crimp Tool: HT801/MDF97-22S (HIROSE ELECTRIC CO., LTD.)

● Connection Cable (Sold separately)

◇ Motor Connection Cable

Product Name	Length L [m]
LC2U06E	0.6
LC2U10E	1

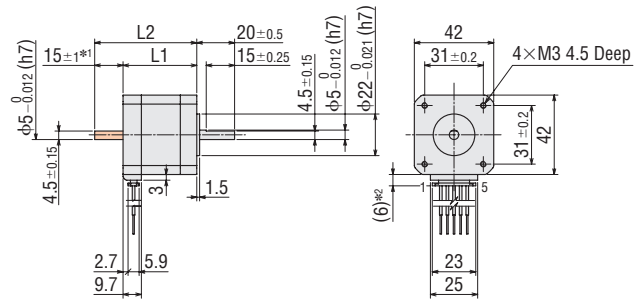
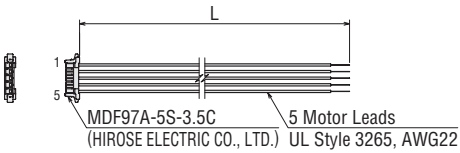

*1 The length of the shaft flat on the double shaft model is 15 ± 0.25 .

*2 With connection cable

● These dimensions are for double shaft motors.

For single shaft motors, ignore the shaded areas.

Inner Wiring Diagram of Motor

Wiring Diagram No.: Model A②

● See "Inner Wiring Diagram of Motor" page for the inner wiring diagram of the motor.

2-Phase
Motors
PKP

Features
Product
Line

Product
Number
Product Line

Standard
Type

High-
Resolution
Type

Flat
Type

SH Geared
Type

CS Geared
Type

Common
Specifications

Inner
Wiring
of Motor

5-Phase
Motors
PKP

Features
Product
Line

Product
Number
Product Line

Standard
Type

High-
Resolution
Type

TS Geared
Type

Common
Specifications

Motor
Pin
Arrangement

Drivers for
2-Phase/5-Phase
Motors

Peripheral
Equipment

Standard Type Frame Size 42 mm (Unipolar 6 lead wires)

Connector Type

Specifications

Product Name	Maximum Holding Torque [Nm]	Rotor Inertia J: kgm ²	Rated Current A/Phase	Voltage VDC	Winding Resistance Ω/Phase	Inductance mH/Phase	Basic Step Angle
PKP243U04□	0.25	36×10 ⁻⁷	0.4	12	30	33	1.8°
PKP243U06□			0.6	6.6	11	12.4	
PKP243U09□			0.95	4.47	4.7	5	
PKP244U04□	0.36	57×10 ⁻⁷	0.4	12	30	28.6	
PKP244U08□			0.8	5.76	7.2	7.6	
PKP244U12□			1.2	4.8	4	3.9	
PKP245U05□	0.45	83×10 ⁻⁷	0.5	12	24	33	
PKP245U08□			0.8	6.4	8	11.3	
PKP245U12□			1.2	4.56	3.8	5	
PKP246U12□	0.75	114×10 ⁻⁷	1.2	7.2	6	6.5	

● The box □ in the product name indicates the shaft **A** (single shaft) or **B** (double shaft).

*See "Drivers for 2-Phase / 5-Phase Motors" page for details on the recommended drivers.

Note

● Be sure to set the driver current at or below the motor rated current. If the motor rated current is exceeded, the product will be damaged.

Speed – Torque Characteristics (Reference values) fs: Max. Starting Frequency

PKP243U04A/PKP243U04B

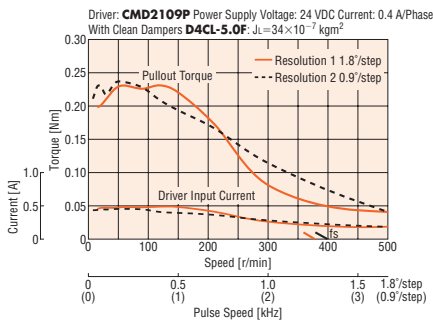

PKP243U06A/PKP243U06B

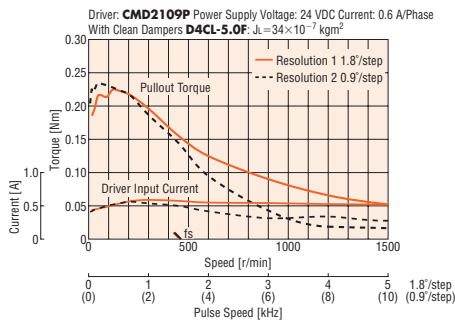

PKP243U09A/PKP243U09B

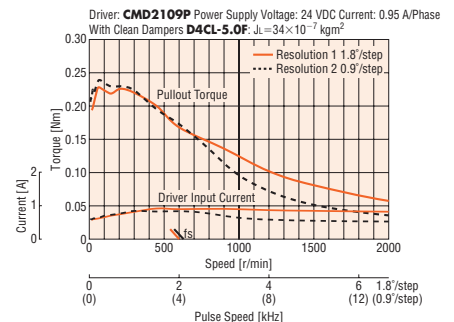

PKP244U04A/PKP244U04B

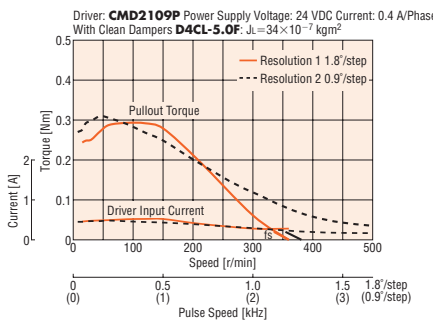

PKP244U08A/PKP244U08B

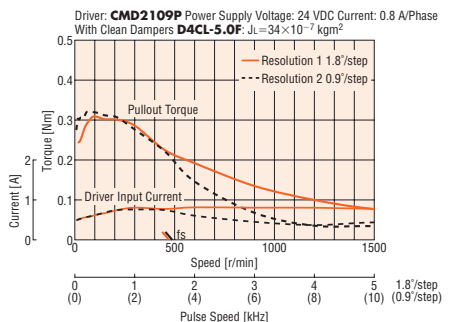

PKP244U12A/PKP244U12B

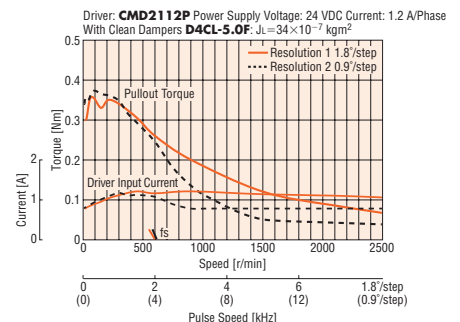

Note

- Data for the speed – torque characteristics is based on Oriental Motor's internal measurement conditions. If the conditions are changed, the characteristics may also change as a result.
- If there is a "clean damper" entry in the speed - torque characteristics, the data is for a double shaft motor when a clean damper is equipped.
- Depending on the driving conditions, a considerable amount of heat may be generated by the motor. Be sure to keep the motor case temperature at 100°C or less.

Speed – Torque Characteristics (Reference values) fs: Max. Starting Frequency

PKP245U05A/ PKP245U05B

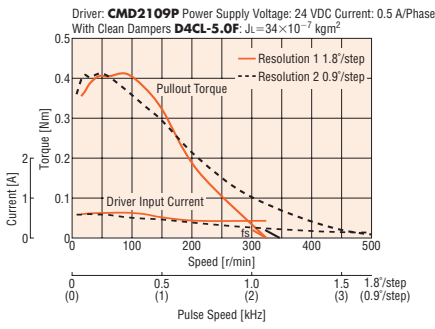

PKP245U08A/ PKP245U08B

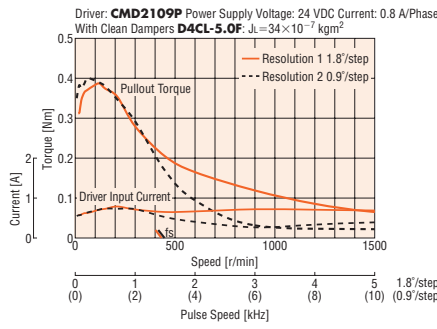

PKP245U12A/ PKP245U12B

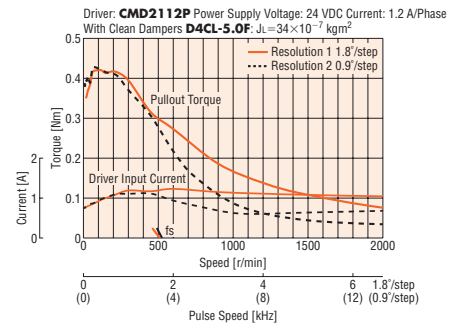

PKP246U12A/ PKP246U12B

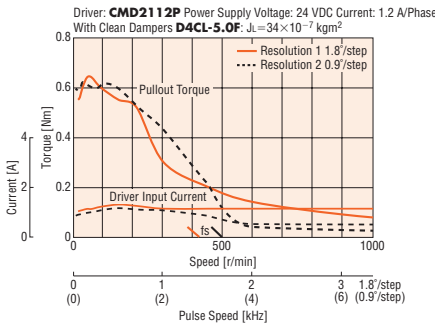

Note

- Data for the speed – torque characteristics is based on Oriental Motor's internal measurement conditions. If the conditions are changed, the characteristics may also change as a result.
- If there is a "clean damper" entry in the speed - torque characteristics, the data is for a double shaft motor when a clean damper is equipped.
- Depending on the driving conditions, a considerable amount of heat may be generated by the motor. Be sure to keep the motor case temperature at 100°C or less.

Dimensions (Unit: mm)

● Motor

Product Name	L1	L2	Mass [kg]
PKP243U04A	33	—	0.25
PKP243U04B		48	
PKP243U06A		—	
PKP243U06B		48	
PKP243U09A		—	
PKP243U09B		48	
PKP244U04A	39	—	0.3
PKP244U04B		54	
PKP244U08A		—	
PKP244U08B		54	
PKP244U12A		—	
PKP244U12B		54	
PKP245U05A	47	—	0.39
PKP245U05B		62	
PKP245U08A		—	
PKP245U08B		62	
PKP245U12A		—	
PKP245U12B		62	
PKP246U12A	59	—	0.5
PKP246U12B		74	

- Applicable Connector (Molex)
Connector Housing: 51103-0600 (Molex)
Contact: 50351-8100 (Molex)
Crimp Tool: 57295-5000 (Molex)

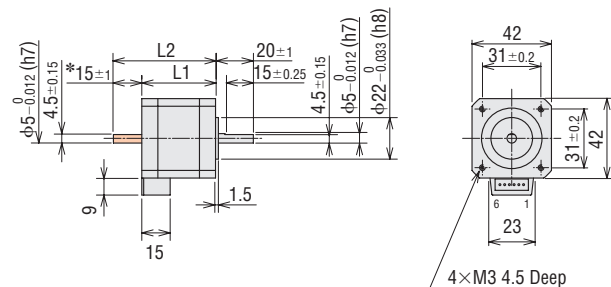

- *The length of the shaft flat on the double shaft model is 15±0.25.
- These dimensions are for double shaft motors.
For single shaft motors, ignore the shaded areas.

● Connection Cable (Sold separately)

◇ Motor Connection Cable

Product Name	Length L [m]
LC2U06B	0.6
LC2U10B	1

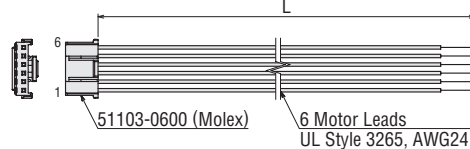

Inner Wiring Diagram of Motor

Wiring Diagram No.: Model B④

- Refer to the motor inner wiring page for an inner wiring diagram of the motor.

2-Phase
Motors
PKP

Features
Product
Line

Product
Number
Product Line

Standard
Type

High-
Resolution
Type

Flat
Type

SH Geared
Type

CS Geared
Type

Common
Specifications

Inner
Wiring
of Motor

5-Phase
Motors
PKP

Features
Product
Line

Product
Number
Product Line

Standard
Type

High-
Resolution
Type

TS Geared
Type

Common
Specifications

Motor
Pin
Arrangement

Drivers for
2-Phase/5-Phase
Motors

Peripheral
Equipment

Standard Type with Encoder Frame Size 42 mm (Bipolar 4 lead wires)

Mini-Connector Type

13 mm

20 mm

28 mm

35 mm

42 mm

50 mm

51 mm

56.4 mm

60 mm

61 mm

85 mm

90 mm

Specifications

Product Name	Maximum Holding Torque [Nm]	Rotor Inertia J: kgm ²	Rated Current A/Phase	Voltage VDC	Winding Resistance Ω/Phase	Inductance mH/Phase	Basic Step Angle	Recommended Driver Product Name*
PKP243D15A2-R2□L	0.35	36×10 ⁻⁷	1.5	2.7	1.8	3.3	1.8°	CVD223FBR-K
PKP243D23A2-R2□L			2.3	1.8	0.78	1.4		
PKP244D15A2-R2□L	0.48	54×10 ⁻⁷	1.5	3.2	2.1	4.4		
PKP244D23A2-R2□L			2.3	2.1	0.93	1.9		
PKP245D15A2-R2□L	0.66	73×10 ⁻⁷	1.5	3.3	2.2	5.3		
PKP245D23A2-R2□L			2.3	2.3	1	2.2		
PKP246D15A2-R2□L	0.99	110×10 ⁻⁷	1.5	4.4	2.9	7.9		
PKP246D23A2-R2□L			2.3	3.2	1.4	3.3		

● Either **E** (200 P/R) or **F** (400 P/R) indicating the encoder resolution is entered where the box □ is located within the product name.

● See "Common Specifications" page for encoder specifications.

*See "Drivers for 2-Phase / 5-Phase Motors" page for drivers that can be used in combination.

Note

● Be sure to set the driver current at or below the motor rated current. If the motor rated current is exceeded, the product will be damaged.

Speed – Torque Characteristics (Reference values) fs: Max. Starting Frequency

PKP243D15A2-R2EL/PKP243D15A2-R2FL

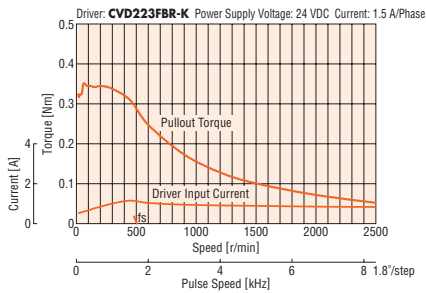

PKP243D23A2-R2EL/PKP243D23A2-R2FL

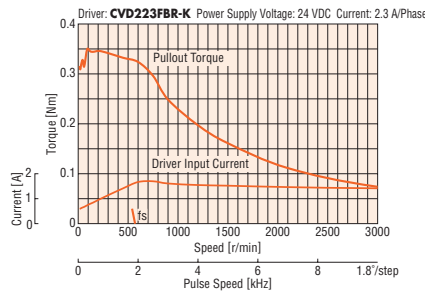

PKP244D15A2-R2EL/PKP244D15A2-R2FL

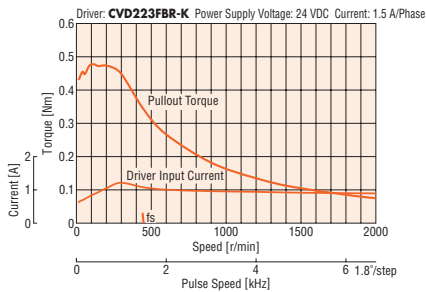

PKP244D23A2-R2EL/PKP244D23A2-R2FL

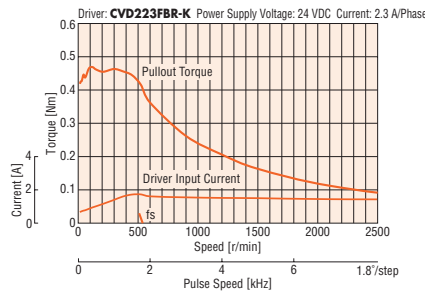

PKP245D15A2-R2EL/PKP245D15A2-R2FL

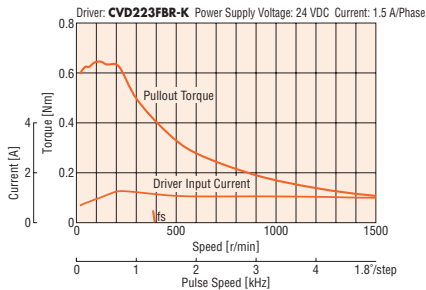

PKP245D23A2-R2EL/PKP245D23A2-R2FL

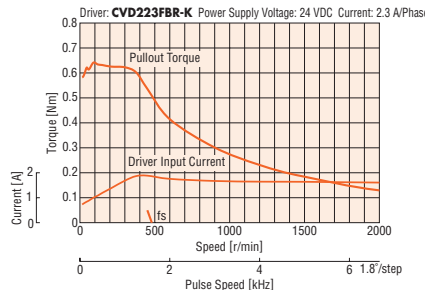

Note

● Data for the speed – torque characteristics is based on Oriental Motor's internal measurement conditions. If the conditions are changed, the characteristics may also change as a result.

● Depending on the driving conditions, a considerable amount of heat may be generated by the motor. To protect the encoder, be sure to keep the motor case temperature at 85°C max.

● The characteristics are the same when RS-485 communication type driver is used in combination.

Speed – Torque Characteristics (Reference values) fs: Max. Starting Frequency

PKP246D15A2-R2EL/ PKP246D15A2-R2FL

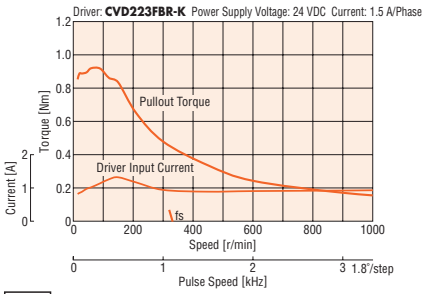

PKP246D23A2-R2EL/ PKP246D23A2-R2FL

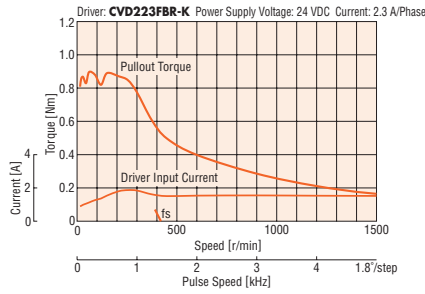

Note

- Data for the speed – torque characteristics is based on Oriental Motor's internal measurement conditions. If the conditions are changed, the characteristics may also change as a result.
- Depending on the driving conditions, a considerable amount of heat may be generated by the motor. To protect the encoder, be sure to keep the motor case temperature at 85°C max.
- The characteristics are the same when RS-485 communication type driver is used in combination.

Dimensions (Unit: mm)

Motor

Product Name	L	Mass [kg]
PKP243D15A2-R2□L	46.5	0.24
PKP243D23A2-R2□L		
PKP244D15A2-R2□L	52.5	0.31
PKP244D23A2-R2□L		
PKP245D15A2-R2□L	60.5	0.38
PKP245D23A2-R2□L		
PKP246D15A2-R2□L	72.5	0.51
PKP246D23A2-R2□L		

- Either **E** (200 P/R) or **F** (400 P/R) indicating the encoder resolution is entered where the box □ is located within the product name.

Applicable Connector

	Motor (HIROSE ELECTRIC CO., LTD.)	Encoder (Molex)
Connector Housing	MDF97A-5S-3.5C	51021-0800
Contact	MDF97-22SC	50079-8100
Crimping Tool	HT801/MDF97-22S	57177-5000

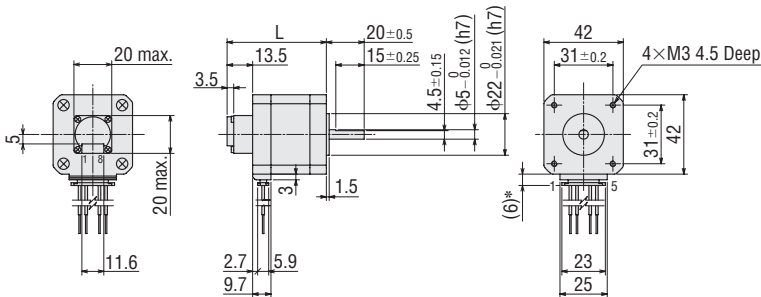

*With connection cable

Connection Cable (Sold separately)

Motor Connection Cable

Product Name	Length L [m]
LC2B06E	0.6
LC2B10E	1

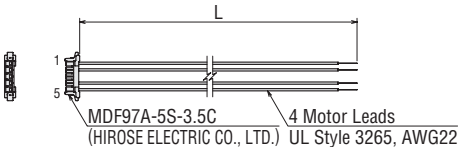

Encoder Connection Cable

Product Name	Length L [m]
LCE08A-006	0.6

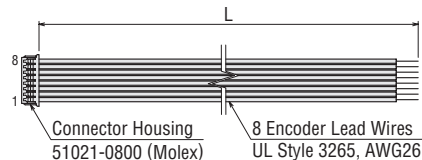

Inner Wiring Diagram of Motor

Wiring Diagram No.: Model A①

- See "Inner Wiring Diagram of Motor" page for the inner wiring diagram of the motor.

2-Phase
Motors
PKP

Features
Product
Line

Product
Number
Product Line

Standard
Type

High-
Resolution
Type

Flat
Type

SH Geared
Type

CS Geared
Type

Common
Specifications

Inner
Wiring
of Motor

5-Phase
Motors
PKP

Features
Product
Line

Product
Number
Product Line

Standard
Type

High-
Resolution
Type

TS Geared
Type

Common
Specifications

Motor
Pin
Arrangement

Drivers for
2-Phase/5-Phase
Motors

Peripheral
Equipment

Standard Type with Encoder Frame Size 42 mm (Unipolar 5 lead wires)

Mini-Connector Type

13 mm

20 mm

28 mm

35 mm

42 mm

50 mm

51 mm

56.4 mm

60 mm

61 mm

85 mm

90 mm

Specifications

Product Name	Maximum Holding Torque [Nm]	Rotor Inertia J: kgm ²	Rated Current A/Phase	Voltage VDC	Winding Resistance Ω/Phase	Inductance mH/Phase	Basic Step Angle
PKP243U09A2-R2□L	0.26	36×10 ⁻⁷	0.95	4.5	4.7	3.7	1.8°
PKP244U12A2-R2□L	0.39	54×10 ⁻⁷	1.2	4.8	4	3.7	
PKP245U12A2-R2□L	0.49	73×10 ⁻⁷	1.2	3.8	3.2	3.7	
PKP246U12A2-R2□L	0.75	110×10 ⁻⁷	1.2	6.1	5.1	6	

● Either **E** (200 P/R) or **F** (400 P/R) indicating the encoder resolution is entered where the box □ is located within the product name.

● See "Common Specifications" page for encoder specifications.

*See "Drivers for 2-Phase / 5-Phase Motors" page for details on the recommended drivers.

Note

● Be sure to set the driver current at or below the motor rated current. If the motor rated current is exceeded, the product will be damaged.

Speed – Torque Characteristics (Reference values) fs: Max. Starting Frequency

PKP243U09A2-R2EL/PKP243U09A2-R2FL

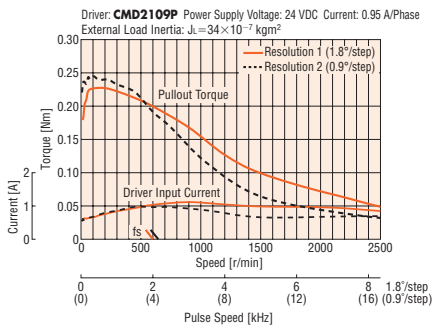

PKP244U12A2-R2EL/PKP244U12A2-R2FL

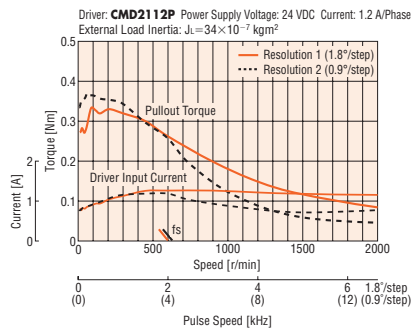

PKP245U12A2-R2EL/PKP245U12A2-R2FL

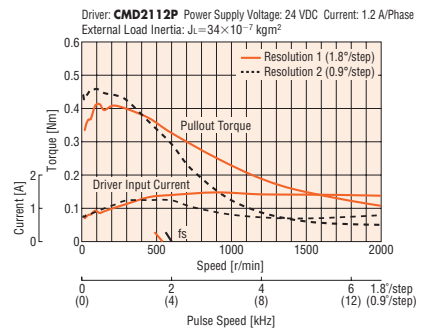

Note

● Data for the speed – torque characteristics is based on Oriental Motor's internal measurement conditions. If the conditions are changed, the characteristics may also change as a result.

● The data in the speed – torque characteristics represents the use of an external load inertia.

● Depending on the driving conditions, a considerable amount of heat may be generated by the motor. To protect the encoder, be sure to keep the motor case temperature at 85°C max.

Speed – Torque Characteristics (Reference values) fs: Max. Starting Frequency

PKP246U12A2-R2EL/PKP246U12A2-R2FL

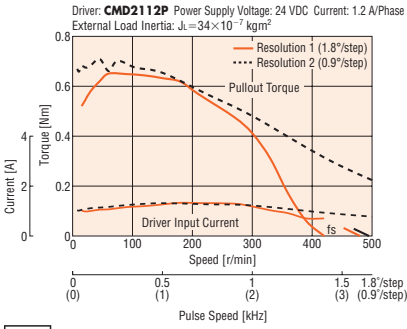

Note

- Data for the speed – torque characteristics is based on Oriental Motor's internal measurement conditions. If the conditions are changed, the characteristics may also change as a result.
- The data in the speed – torque characteristics represents the use of an external load inertia.
- Depending on the driving conditions, a considerable amount of heat may be generated by the motor. To protect the encoder, be sure to keep the motor case temperature at 85°C max.

Dimensions (Unit: mm)

● Motor

Product Name	L	Mass [kg]
PKP243U09A2-R2□L	46.5	0.24
PKP244U12A2-R2□L	52.5	0.31
PKP245U12A2-R2□L	60.5	0.38
PKP246U12A2-R2□L	72.5	0.51

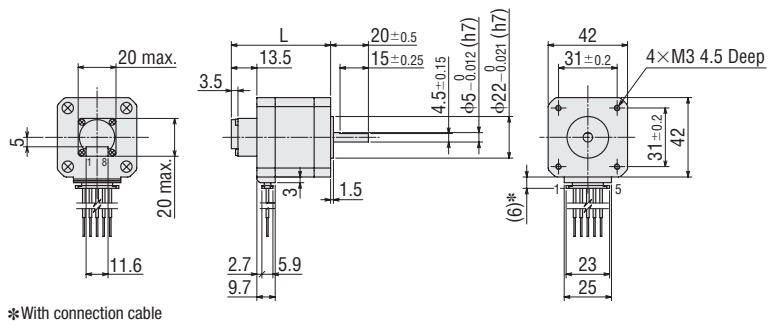

- Either **E** (200 P/R) or **F** (400 P/R) indicating the encoder resolution is entered where the box □ is located within the product name.

● Applicable Connector

	Motor (HIROSE ELECTRIC CO., LTD.)	Encoder (Molex)
Connector Housing	MDF97A-5S-3.5C	51021-0800
Contact	MDF97-22SC	50079-8100
Crimping Tool	HT801/MDF97-22S	57177-5000

● Connection Cable (Sold separately)

◇ Motor Connection Cable

Product Name	Length L [m]
LC2U06E	0.6
LC2U10E	1

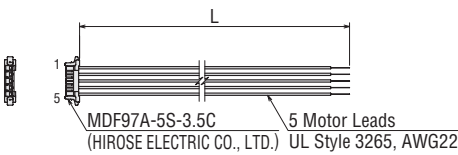

◇ Encoder Connection Cable

Product Name	Length L [m]
LCE08A-006	0.6

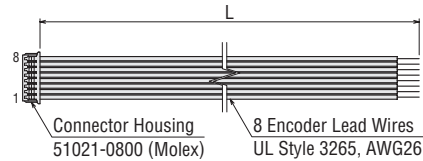

Inner Wiring Diagram of Motor

Wiring Diagram No.: Model A②

- See "Inner Wiring Diagram of Motor" page for the inner wiring diagram of the motor.

2-Phase
Motors
PKP

Features
Product
Line

Product
Number
Product Line

Standard
Type

High-
Resolution
Type

Flat
Type

SH Geared
Type

CS Geared
Type

Common
Specifications

Inner
Wiring
of Motor

5-Phase
Motors
PKP

Features
Product
Line

Product
Number
Product Line

Standard
Type

High-
Resolution
Type

TS Geared
Type

Common
Specifications

Motor
Pin
Arrangement

Drivers for
2-Phase/5-Phase
Motors

Peripheral
Equipment

Standard Type with Electromagnetic Brake Frame Size 42 mm (Bipolar 4 lead wires)

Mini-Connector Type

Specifications

Product Name	Maximum Holding Torque [Nm]	Rotor Inertia J: kg·m ²	Rated Current A/Phase	Voltage VDC	Winding Resistance Ω/Phase	Inductance mH/Phase	Basic Step Angle	Electromagnetic Brake Static Friction Torque [Nm]
PKP243D23M2	0.35	48×10 ⁻⁷ *	2.3	1.8	0.78	1.4	1.8°	0.3
PKP244D23M2	0.48	66×10 ⁻⁷ *		2.1	0.93	1.9		
PKP245D23M2	0.66	85×10 ⁻⁷ *		2.3	1	2.2		
PKP246D23M2	0.99	120×10 ⁻⁷ *		3.2	1.4	3.3		

● Refer to the common specification page for electromagnetic brake specifications.

*The Inertia of the electromagnetic brake is included in the value.

Note

● Be sure to set the driver current at or below the motor rated current. If the motor rated current is exceeded, the product will be damaged.

Speed – Torque Characteristics (Reference values) fs: Max. Starting Frequency

PKP243D23M2

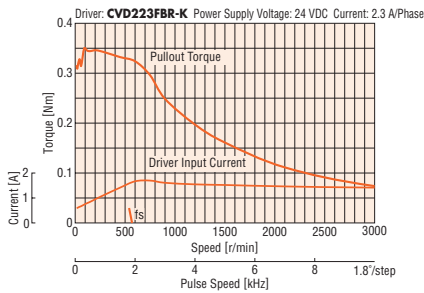

PKP244D23M2

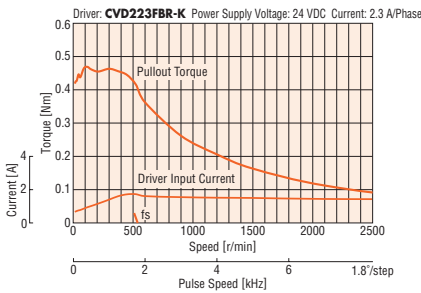

PKP245D23M2

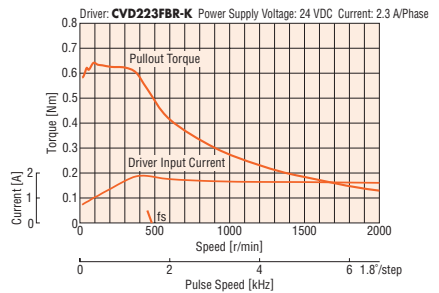

PKP246D23M2

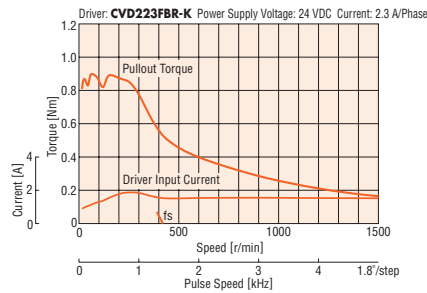

Note

- Data for the speed – torque characteristics is based on Oriental Motor's internal measurement conditions. If the conditions are changed, the characteristics may also change as a result.
- Depending on the driving conditions, a considerable amount of heat may be generated by the motor. Be sure to keep the motor case temperature at 100°C max.
- The characteristics are the same when RS-485 communication type driver is used in combination.

Dimensions (Unit: mm)

Motor

Product Name	L1	L2	Mass [kg]
PKP243D23M2	69	49	0.33
PKP244D23M2	75	55	0.40
PKP245D23M2	83	63	0.47
PKP246D23M2	95	75	0.60

● Applicable Connector

	Motor (HIROSE ELECTRIC CO., LTD.)	Electromagnetic Brake (HIROSE ELECTRIC CO., LTD.)
Connector Housing	MDF97A-5S-3.5C	DF62C-2S-2.2C
Contact	MDF97-22SC	DF62-22SCA
Crimping Tool	HT801/MDF97-22S	HT801/DF62-22(10)

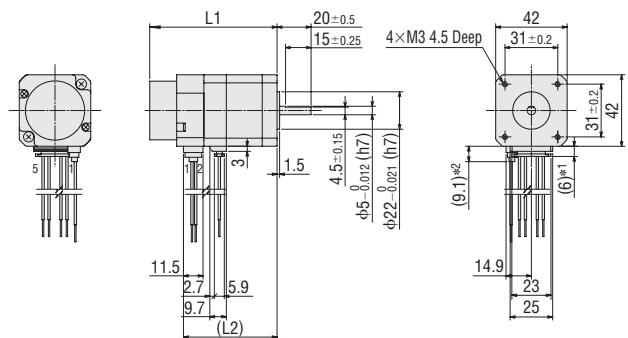

- *1 With connection cable
- *2 With electromagnetic brake connection cable

Connection Cable (Sold separately)

Motor Connection Cable

Product Name	Length L [m]
LC2B06E	0.6
LC2B10E	1

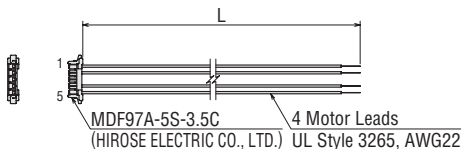

Electromagnetic Brake Connection Cable

Product Name	Length L [m]
LCM02A-006	0.6
LCM02A-010	1

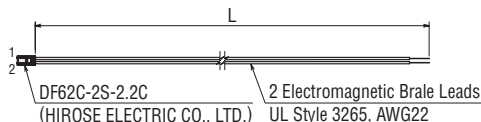

Inner Wiring Diagram of Motor

Wiring Diagram No.: Model A①

● See "Inner Wiring Diagram of Motor" page for the inner wiring diagram of the motor.

Standard Type with Electromagnetic Brake Frame Size 42 mm (Unipolar 6 lead wires) Connector Type

2-Phase
Motors
PKP

Features
Product
Line

Product
Number
Product Line

Standard
Type

High-
Resolution
Type

Flat
Type

SH Geared
Type

CS Geared
Type

Common
Specifications

Inner
Wiring
of Motor

5-Phase
Motors
PKP

Features
Product
Line

Product
Number
Product Line

Standard
Type

High-
Resolution
Type

TS Geared
Type

Common
Specifications

Motor
Pin
Arrangement

Drivers for
2-Phase/5-Phase
Motors

Peripheral
Equipment

Specifications

Product Name	Maximum Holding Torque [Nm]	Rotor Inertia J: kgm ²	Rated Current A/Phase	Voltage VDC	Winding Resistance Ω/Phase	Inductance mH/Phase	Basic Step Angle	Electromagnetic Brake Static Friction Torque [Nm]
PKP243U09M	0.25	48×10 ⁻⁷ *	0.95	4.47	4.7	5	1.8°	0.3
PKP244U12M	0.39	69×10 ⁻⁷ *	1.2	4.8	4	3.9		
PKP245U12M	0.45	95×10 ⁻⁷ *		4.56	3.8	5		
PKP246U12M	0.75	126×10 ⁻⁷ *	7.2	6	6.5			

● Refer to the common specification page for electromagnetic brake specifications.

*This value is including the electromagnetic brake inertia.

Note

● Be sure to set the driver current at or below the motor rated current. If the motor rated current is exceeded, the product will be damaged.

Speed – Torque Characteristics (Reference values) fs: Max. Starting Frequency

PKP243U09M

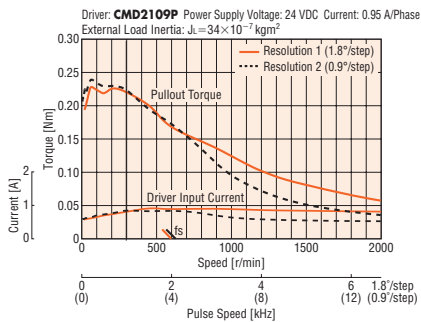

PKP244U12M

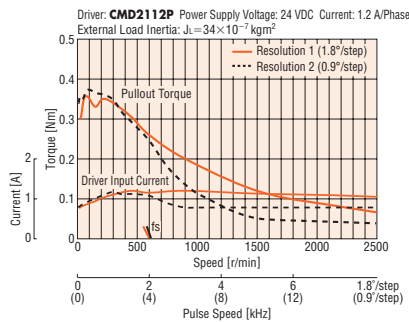

PKP245U12M

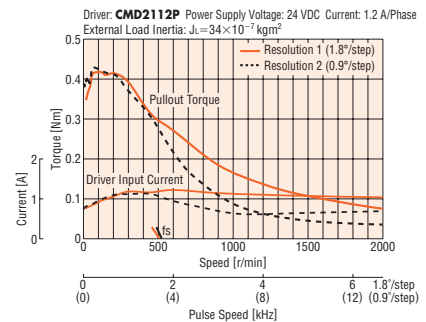

PKP246U12M

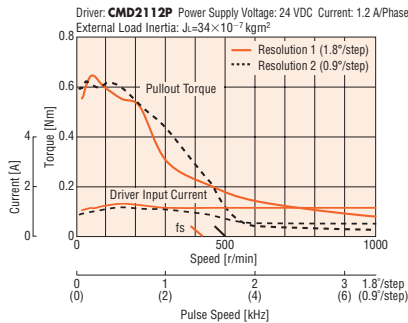

Note

● Data for the speed – torque characteristics is based on Oriental Motor's internal measurement conditions. If the conditions are changed, the characteristics may also change as a result.

● The data in the speed – torque characteristics represents the use of an external load inertia.

● Depending on the driving conditions, a considerable amount of heat may be generated by the motor. Be sure to keep the motor case temperature at 100°C max.

Dimensions (Unit: mm)

Motor

Product Name	L	Mass [kg]
PKP243U09M	67	0.36
PKP244U12M	73	0.41
PKP245U12M	81	0.5
PKP246U12M	93	0.61

● Applicable Connector (Molex)

Connector Housing: 51103-0600

Contact: 50351-8100

Crimp Tool: 57295-5000

Connection Cable (Sold separately)

Motor Connection Cable

Product Name	Length L [m]
LC2U06B	0.6
LC2U10B	1

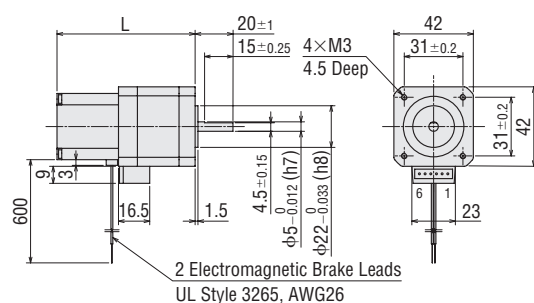
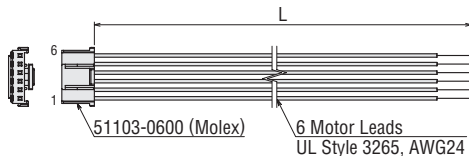

Inner Wiring Diagram of Motor

Wiring Diagram No.: Model B④

● See "Inner Wiring Diagram of Motor" page for the inner wiring diagram of the motor.

Standard Type Frame Size 56.4 mm (Bipolar 4 lead wires)

Mini-Connector Type

13 mm

20 mm

28 mm

35 mm

42 mm

50 mm

51 mm

56.4 mm

60 mm

61 mm

85 mm

90 mm

Specifications

Product Name	Maximum Holding Torque [Nm]	Rotor Inertia J: kgm ²	Rated Current A/Phase	Voltage VDC	Winding Resistance Ω/Phase	Inductance mH/Phase	Basic Step Angle	Recommended Driver Product Name*
PKP264D14□2	0.74	140×10 ⁻⁷	1.4	2.9	2.1	6	1.8°	CVD228BR-K
PKP264D28□2			2.8	1.6	0.57	1.5		CVD242BR-K
PKP264D42□2			4.2	1	0.24	0.65		CVD228BR-K
PKP266D14□2	1.4	270×10 ⁻⁷	1.4	4.6	3.3	12		CVD228BR-K
PKP266D28□2			2.8	2.4	0.86	2.9		CVD242BR-K
PKP266D42□2			4.2	1.6	0.38	1.3		CVD228BR-K
PKP268D14□2	2.5	500×10 ⁻⁷	1.4	6.6	4.7	18		CVD228BR-K
PKP268D28□2			2.8	3.4	1.2	4.6		CVD228BR-K
PKP268D42□2			4.2	2.2	0.53	2		CVD242BR-K

● The box □ in the product name indicates the shaft **A** (single shaft) or **B** (double shaft).

*See "Drivers for 2-Phase / 5-Phase Motors" page for drivers that can be used in combination.

Note

● Be sure to set the driver current at or below the motor rated current. If the motor rated current is exceeded, the product will be damaged.

Speed – Torque Characteristics (Reference values) fs: Max. Starting Frequency

PKP264D14A2/PKP264D14B2

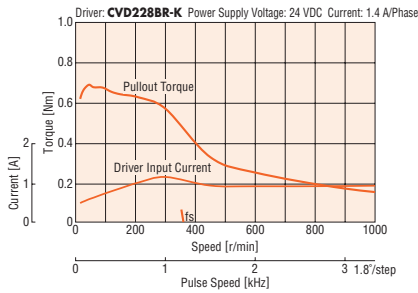

PKP264D28A2/PKP264D28B2

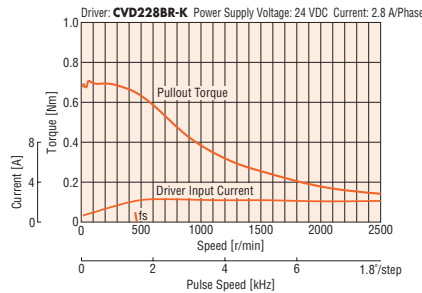

PKP264D42A2/PKP264D42B2

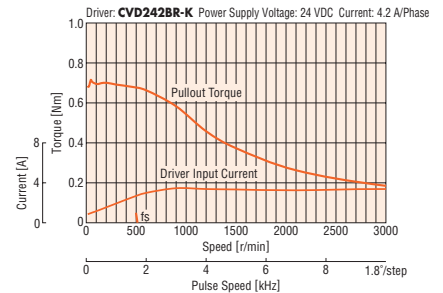

PKP266D14A2/PKP266D14B2

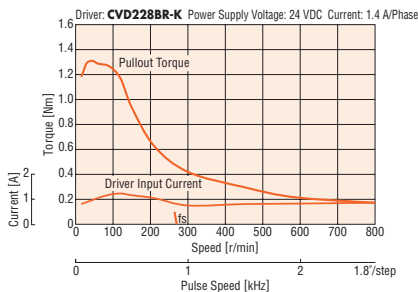

PKP266D28A2/PKP266D28B2

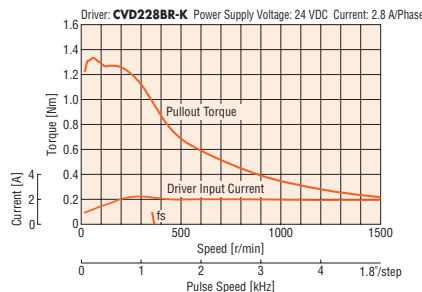

PKP266D42A2/PKP266D42B2

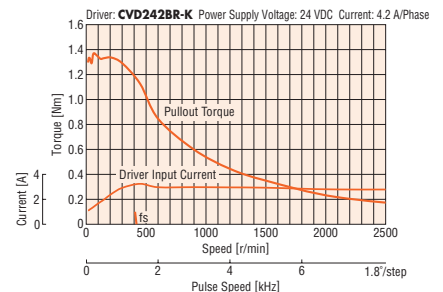

PKP268D14A2/PKP268D14B2

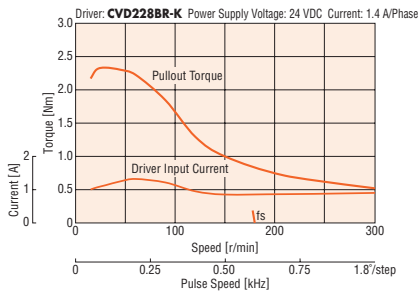

PKP268D28A2/PKP268D28B2

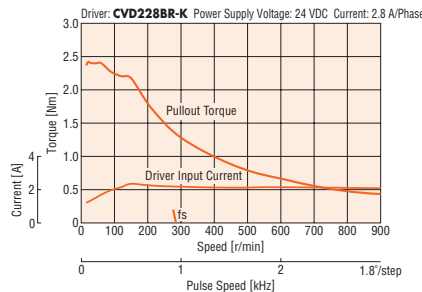

PKP268D42A2/PKP268D42B2

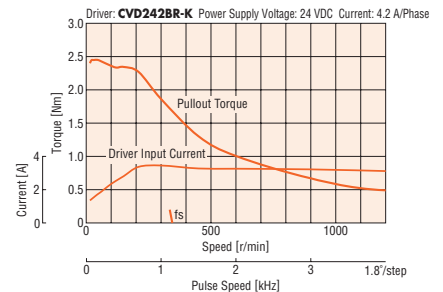

Note

● Data for the speed – torque characteristics is based on Oriental Motor's internal measurement conditions. If the conditions are changed, the characteristics may also change as a result.

● Depending on the driving conditions, a considerable amount of heat may be generated by the motor. Be sure to keep the motor case temperature at 100°C max.

● The characteristics are the same when RS-485 communication type driver is used in combination.

Dimensions (Unit: mm)

Motor

Product Name	L1	L2	Mass [kg]
PKP264D14A2	39	—	0.45
PKP264D14B2		62	
PKP264D28A2		—	
PKP264D28B2		62	
PKP264D42A2		—	
PKP264D42B2		62	
PKP266D14A2	54	—	0.7
PKP266D14B2		77	
PKP266D28A2		—	
PKP266D28B2		77	
PKP266D42A2		—	
PKP266D42B2		77	
PKP268D14A2	76	—	1.1
PKP268D14B2		99	
PKP268D28A2		—	
PKP268D28B2		99	
PKP268D42A2		—	
PKP268D42B2		99	

● Applicable Connector

Connector Housing: MDF97A-5S-3.5C (HIROSE ELECTRIC CO., LTD.)

Contact: MDF97-22SC (HIROSE ELECTRIC CO., LTD.)

Crimp Tool: HT801/MDF97-22S (HIROSE ELECTRIC CO., LTD.)

● Connection Cable (Sold separately)

◇ Motor Connection Cable

Product Name	Length L [m]
LC2B06E	0.6
LC2B10E	1

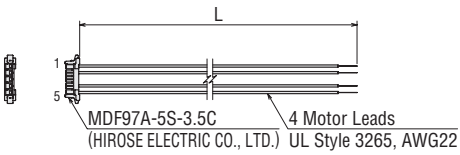

Inner Wiring Diagram of Motor

Wiring Diagram No.: Model A①

● See "Inner Wiring Diagram of Motor" page for the inner wiring diagram of the motor.

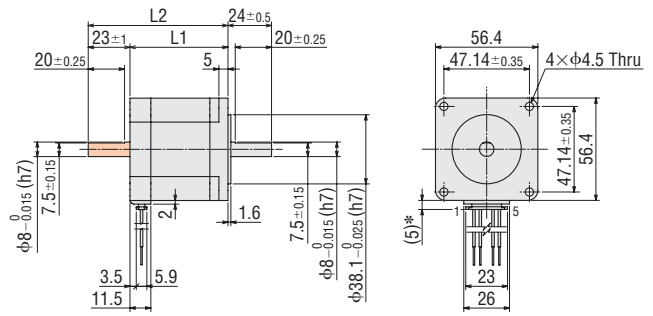

*With connection cable

● These dimensions are for double shaft motors.

For single shaft motors, ignore the shaded  areas.

2-Phase
Motors
PKP

Features
Product
Line

Product
Number
Product Line

Standard
Type

High-
Resolution
Type

Flat
Type

SH Geared
Type

CS Geared
Type

Common
Specifications

Inner
Wiring
of Motor

5-Phase
Motors
PKP

Features
Product
Line

Product
Number
Product Line

Standard
Type

High-
Resolution
Type

TS Geared
Type

Common
Specifications

Motor
Pin
Arrangement

Drivers for
2-Phase/5-Phase
Motors

Peripheral
Equipment

Standard Type Frame Size 56.4 mm (Bipolar 4 lead wires)

Connector Type

Specifications

Product Name	Maximum Holding Torque [Nm]	Rotor Inertia J: kgm ²	Rated Current A/Phase	Voltage VDC	Winding Resistance Ω/Phase	Inductance mH/Phase	Basic Step Angle	Recommended Driver Product Name*
PKP264D28□	0.6	120×10 ⁻⁷	2.8	2	0.73	1.8	1.8°	CVD228BR-K
PKP266D28□	1.4	290×10 ⁻⁷		2.8	1	2.9		
PKP268D28□	2.3	490×10 ⁻⁷		3.4	1.23	4.4		

● The box □ in the product name indicates the shaft **A** (single shaft) or **B** (double shaft).

*See "Drivers for 2-Phase / 5-Phase Motors" page for drivers that can be used in combination.

Note

● Be sure to set the driver current at or below the motor rated current. If the motor rated current is exceeded, the product will be damaged.

Speed – Torque Characteristics (Reference values) fs: Max. Starting Frequency

PKP264D28A/ PKP264D28B

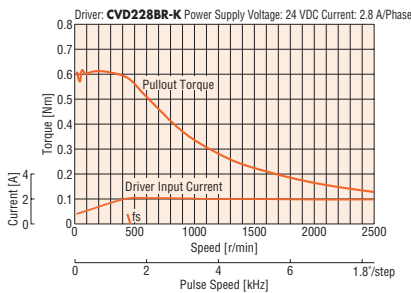

PKP266D28A/ PKP266D28B

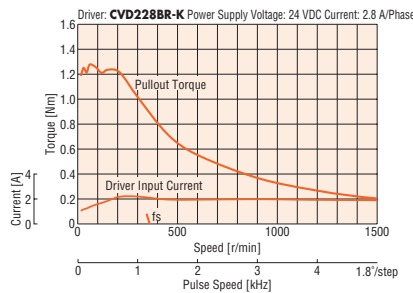

PKP268D28A/ PKP268D28B

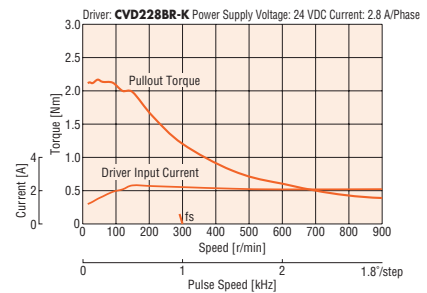

Note

- Data for the speed – torque characteristics is based on Oriental Motor's internal measurement conditions. If the conditions are changed, the characteristics may also change as a result.
- Depending on the driving conditions, a considerable amount of heat may be generated by the motor. Be sure to keep the motor case temperature at 100°C or less.
- The characteristics are the same if combined with an RS-485 communication type driver.

Dimensions (Unit: mm)

Motor

Product Name	L1	L2	Mass [kg]
PKP264D28A	39	—	0.46
PKP264D28B		62	
PKP266D28A	54	—	0.73
PKP266D28B		77	
PKP268D28A	76	—	1.1
PKP268D28B		99	

- Applicable Connector (Molex)
Connector Housing: 51067-0600 (Molex)
Contact: 50217-9101 (Molex)
Crimp Tool: 57189-5000 (Molex)
57190-5000 (Molex)

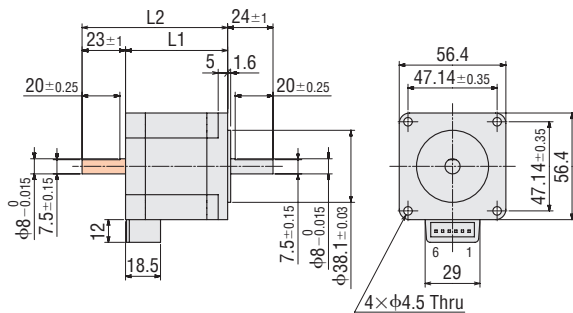

- These dimensions are for double shaft motors.
For single shaft motors, ignore the shaded areas.

Connection Cable (Sold separately)

◇ Motor Connection Cable

Product Name	Length L [m]
LC2B06C	0.6
LC2B10C	1

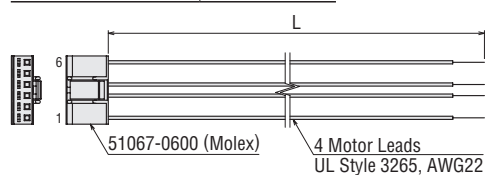

Inner Wiring Diagram of Motor

Wiring Diagram No.: Model B③

- Refer to the motor inner wiring page for an inner wiring diagram of the motor.

Standard Type Frame Size 56.4 mm (Unipolar 5 lead wires)

Mini-Connector Type

Specifications

Product Name	Maximum Holding Torque [Nm]	Rotor Inertia J: kgm ²	Rated Current A/Phase	Voltage VDC	Winding Resistance Ω/Phase	Inductance mH/Phase	Basic Step Angle
PKP264U10□2	0.58	140×10 ⁻⁷	1	4.4	4.4	6	1.8°
PKP264U20□2			2	2.2	1.1	1.5	
PKP266U10□2	1.1	270×10 ⁻⁷	1	6.9	6.9	11.6	
PKP266U20□2			2	3.4	1.7	2.9	
PKP268U10□2	2	500×10 ⁻⁷	1	9.9	9.9	18.4	
PKP268U20□2			2	4.8	2.4	4.6	

● The box □ in the product name indicates the shaft **A** (single shaft) or **B** (double shaft).

*See "Drivers for 2-Phase / 5-Phase Motors" page for details on the recommended drivers.

Note

● Be sure to set the driver current at or below the motor rated current. If the motor rated current is exceeded, the product will be damaged.

Speed – Torque Characteristics (Reference values) fs: Max. Starting Frequency

PKP264U10A2/PKP264U10B2

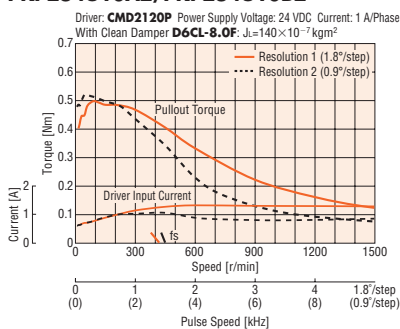

PKP266U10A2/PKP266U10B2

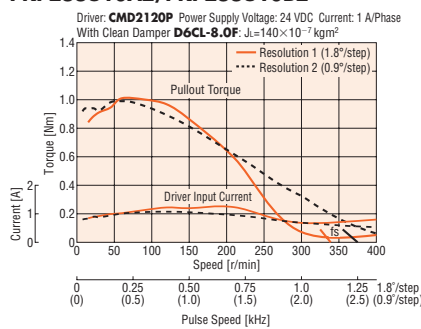

PKP268U10A2/PKP268U10B2

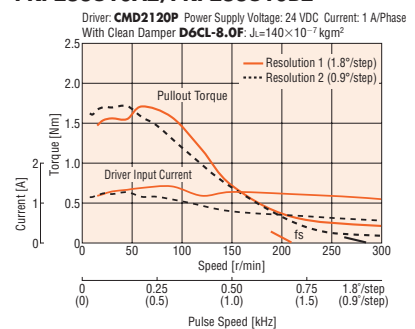

PKP264U20A2/PKP264U20B2

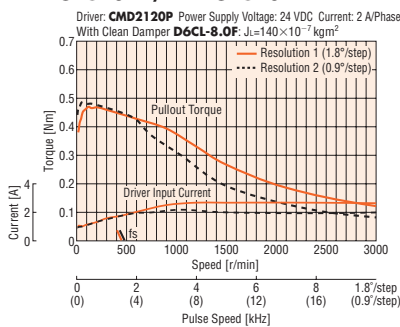

PKP266U20A2/PKP266U20B2

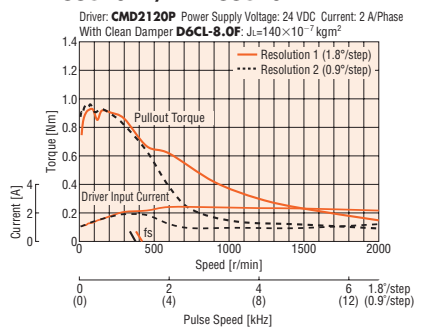

PKP268U20A2/PKP268U20B2

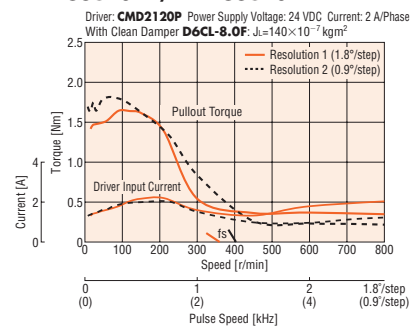

Note

● Data for the speed – torque characteristics is based on Oriental Motor's internal measurement conditions. If the conditions are changed, the characteristics may also change as a result.

● If there is a "clean damper" entry in the speed – torque characteristics, the data is for a double shaft motor when a clean damper is equipped.

● Depending on the driving conditions, a considerable amount of heat may be generated by the motor. Be sure to keep the motor case temperature at 100°C max.

Dimensions (Unit: mm)

Motor

Product Name	L1	L2	Mass [kg]
PKP264U10A2	39	—	0.45
PKP264U10B2		62	
PKP264U20A2		—	
PKP264U20B2	54	62	0.7
PKP266U10A2		—	
PKP266U10B2		77	
PKP266U20A2	76	—	1.1
PKP266U20B2		77	
PKP268U10A2		—	
PKP268U10B2	99	—	1.1
PKP268U20A2		—	
PKP268U20B2		99	

● Applicable Connector

Connector Housing: MDF97A-5S-3.5C (HIROSE ELECTRIC CO., LTD.)

Contact: MDF97-22SC (HIROSE ELECTRIC CO., LTD.)

Crimp Tool: HT801/MDF97-22S (HIROSE ELECTRIC CO., LTD.)

Inner Wiring Diagram of Motor

Wiring Diagram No.: Model A②

● See "Inner Wiring Diagram of Motor" page for the inner wiring diagram of the motor.

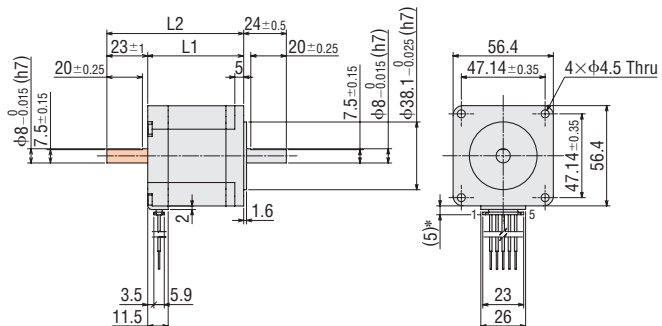

*With connection cable

● These dimensions are for double shaft motors.

For single shaft motors, ignore the shaded areas.

Connection Cable (Sold separately)

Motor Connection Cable

Product Name	Length L [m]
LC2U06E	0.6
LC2U10E	1

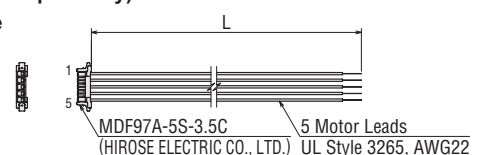

2-Phase Motors PKP

Features Product Line

Product Number Product Line

Standard Type

High-Resolution Type

Flat Type

SH Geared Type

CS Geared Type

Common Specifications

Inner Wiring of Motor

5-Phase Motors PKP

Features Product Line

Product Number Product Line

Standard Type

High-Resolution Type

TS Geared Type

Common Specifications

Motor Pin Arrangement

Drivers for 2-Phase/5-Phase Motors

Peripheral Equipment

Standard Type Frame Size 56.4 mm (Unipolar 6 lead wires)

Connector Type

Specifications

Product Name	Maximum Holding Torque [Nm]	Rotor Inertia J: kgm ²	Rated Current A/Phase	Voltage VDC	Winding Resistance Ω/Phase	Inductance mH/Phase	Basic Step Angle
PKP264U10□	0.51	120×10 ⁻⁷	1	5.87	5.87	7.2	1.8°
PKP264U20□			2	2.9	1.45	1.8	
PKP264U30□			3	1.95	0.65	0.8	
PKP266U10□	1.1	290×10 ⁻⁷	1	8.1	8.1	11.6	
PKP266U20□			2	4	2	2.9	
PKP266U30□			3	2.76	0.92	1.33	
PKP268U10□	1.75	490×10 ⁻⁷	1	9.32	9.32	17.6	
PKP268U20□			2	4.9	2.45	4.4	
PKP268U30□			3	3.15	1.05	1.96	

● The box □ in the product name indicates the shaft **A** (single shaft) or **B** (double shaft).

*See "Drivers for 2-Phase / 5-Phase Motors" page for details on the recommended drivers.

Note

● Be sure to set the driver current at or below the motor rated current. If the motor rated current is exceeded, the product will be damaged.

Speed – Torque Characteristics (Reference values) fs: Max. Starting Frequency

PKP264U10A/PKP264U10B

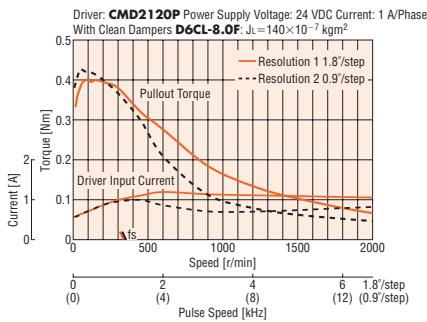

PKP264U20A/PKP264U20B

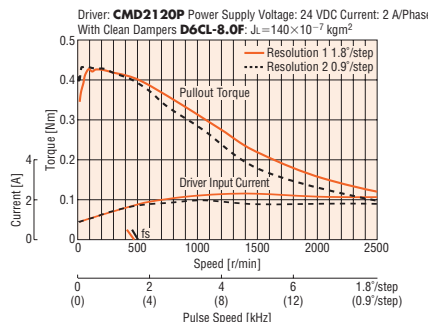

PKP264U30A/PKP264U30B

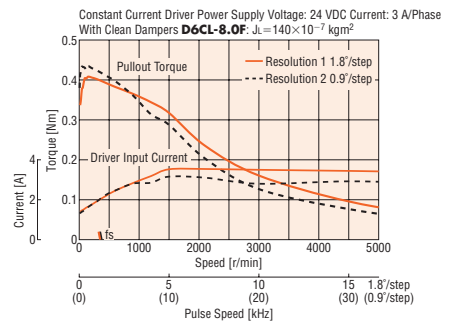

PKP266U10A/PKP266U10B

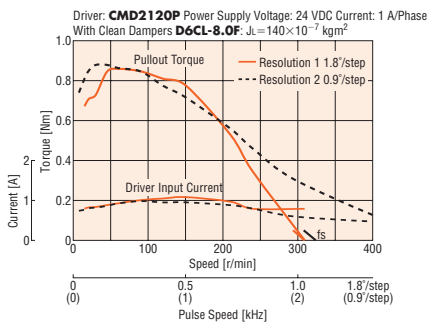

PKP266U20A/PKP266U20B

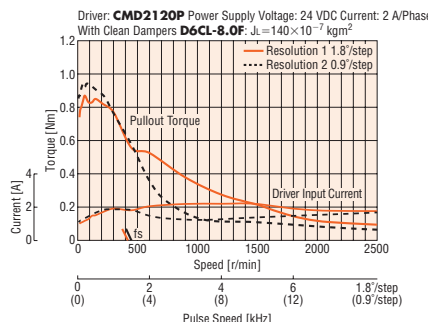

PKP266U30A/PKP266U30B

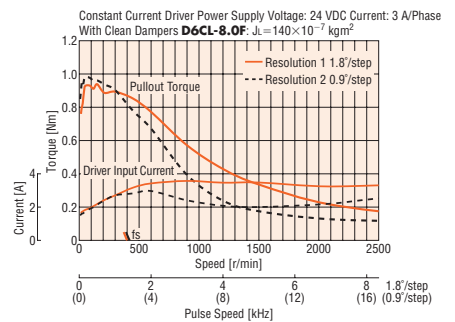

PKP268U10A/PKP268U10B

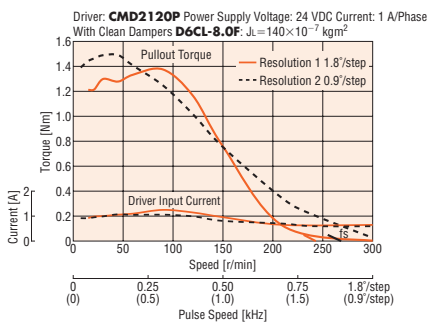

PKP268U20A/PKP268U20B

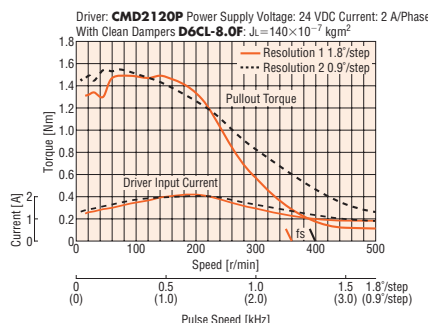

PKP268U30A/PKP268U30B

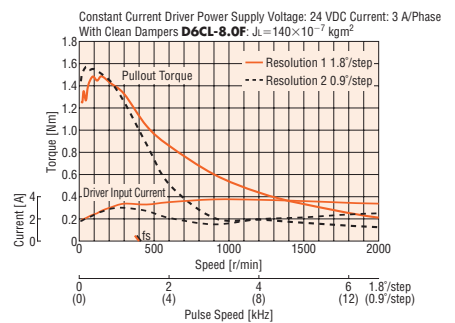

Note

● Data for the speed – torque characteristics is based on Oriental Motor's internal measurement conditions. If the conditions are changed, the characteristics may also change as a result.

● If there is a "clean damper" entry in the speed – torque characteristics, the data is for a double shaft motor when a clean damper is equipped.

● Depending on the driving conditions, a considerable amount of heat may be generated by the motor. Be sure to keep the motor case temperature at 100°C or less.

Dimensions (Unit: mm)

Motor

Product Name	L1	L2	Mass [kg]
PKP264U10A	39	—	0.46
PKP264U10B		62	
PKP264U20A		—	
PKP264U20B		62	
PKP264U30A		—	
PKP264U30B		62	
PKP266U10A	54	—	0.73
PKP266U10B		77	
PKP266U20A		—	
PKP266U20B		77	
PKP266U30A		—	
PKP266U30B		77	
PKP268U10A	76	—	1.1
PKP268U10B		99	
PKP268U20A		—	
PKP268U20B		99	
PKP268U30A		—	
PKP268U30B		99	

- Applicable Connector (Molex)
Connector Housing: 51067-0600 (Molex)
Contact: 50217-9101 (Molex)
Crimp Tool: 57189-5000 (Molex)
57190-5000 (Molex)

Connection Cable (Sold separately)

Motor Connection Cable

Product Name	Length L [m]
LC2U06C	0.6
LC2U10C	1

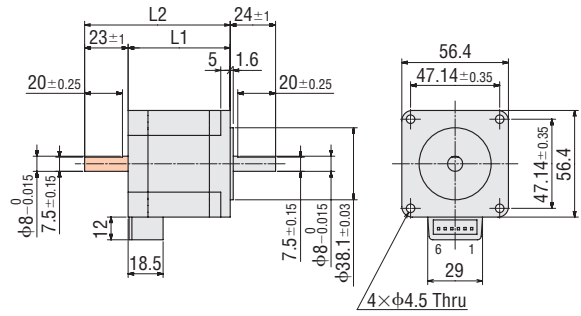
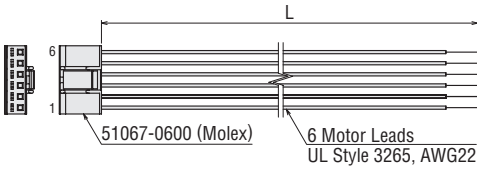

- These dimensions are for double shaft motors.
For single shaft motors, ignore the shaded areas.

Inner Wiring Diagram of Motor

Wiring Diagram No.: Model B④

- Refer to the motor inner wiring page for an inner wiring diagram of the motor.

2-Phase
Motors
PKP

Features
Product
Line

Product
Number
Product Line

Standard
Type

High-
Resolution
Type

Flat
Type

SH Geared
Type

CS Geared
Type

Common
Specifications

Inner
Wiring
of Motor

5-Phase
Motors
PKP

Features
Product
Line

Product
Number
Product Line

Standard
Type

High-
Resolution
Type

TS Geared
Type

Common
Specifications

Motor
Pin
Arrangement

Drivers for
2-Phase/5-Phase
Motors

Peripheral
Equipment

Standard Type with Encoder Frame Size 56.4 mm (Bipolar 4 lead wires)

Mini-Connector Type

□13 mm

□20 mm

□28 mm

□35 mm

□42 mm

□50 mm

□51 mm

□56.4 mm

□60 mm

□61 mm

□85 mm

□90 mm

Specifications

Product Name	Maximum Holding Torque [Nm]	Rotor Inertia J: kgm ²	Rated Current A/Phase	Voltage VDC	Winding Resistance Ω/Phase	Inductance mH/Phase	Basic Step Angle	Recommended Driver Product Name*
PKP264D14A2-R2L□	0.74	140×10 ⁻⁷	1.4	2.9	2.1	6	1.8°	CVD228BR-K
PKP264D28A2-R2L□			2.8	1.6	0.57	1.5		CVD242BR-K
PKP264D42A2-R2L□			4.2	1	0.24	0.65		CVD228BR-K
PKP266D14A2-R2L□	1.4	270×10 ⁻⁷	1.4	4.6	3.3	12		CVD228BR-K
PKP266D28A2-R2L□			2.8	2.4	0.86	2.9		CVD242BR-K
PKP266D42A2-R2L□			4.2	1.6	0.38	1.3		CVD228BR-K
PKP268D14A2-R2L□	2.5	500×10 ⁻⁷	1.4	6.6	4.7	18		CVD228BR-K
PKP268D28A2-R2L□			2.8	3.4	1.2	4.6		CVD242BR-K
PKP268D42A2-R2L□			4.2	2.2	0.53	2		CVD228BR-K

● Either **E** (200 P/R) or **F** (400 P/R) indicating the encoder resolution is entered where the box □ is located within the product name.

● See "Common Specifications" page for encoder specifications.

*See "Drivers for 2-Phase / 5-Phase Motors" page for drivers that can be used in combination.

Note

● Be sure to set the driver current at or below the motor rated current. If the motor rated current is exceeded, the product will be damaged.

Speed – Torque Characteristics (Reference values) fs: Max. Starting Frequency

PKP264D14A2-R2EL/ PKP264D14A2-R2FL

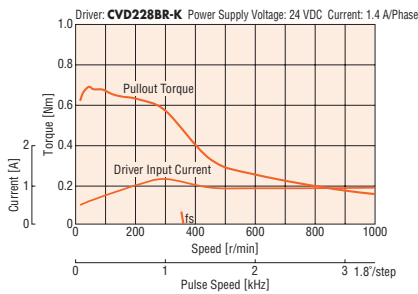

PKP264D28A2-R2EL/ PKP264D28A2-R2FL

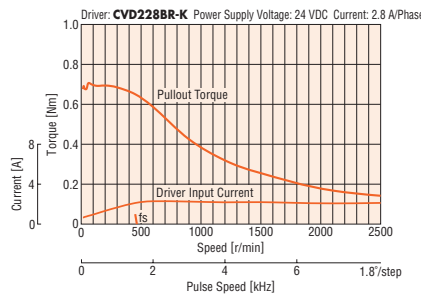

PKP264D42A2-R2EL/ PKP264D42A2-R2FL

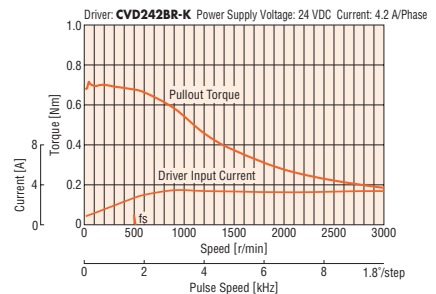

PKP266D14A2-R2EL/ PKP266D14A2-R2FL

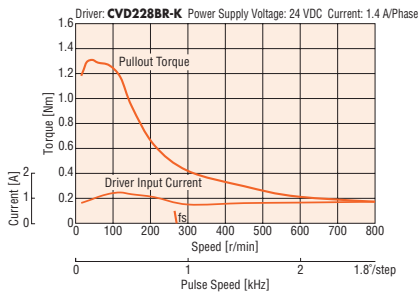

PKP266D28A2-R2EL/ PKP266D28A2-R2FL

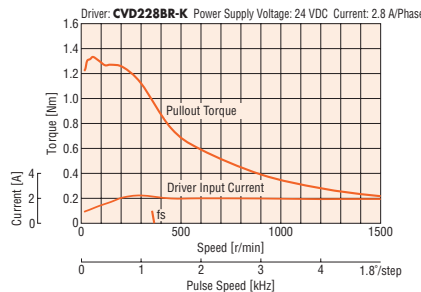

PKP266D42A2-R2EL/ PKP266D42A2-R2FL

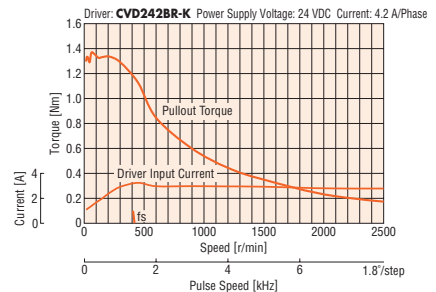

PKP268D14A2-R2EL/ PKP268D14A2-R2FL

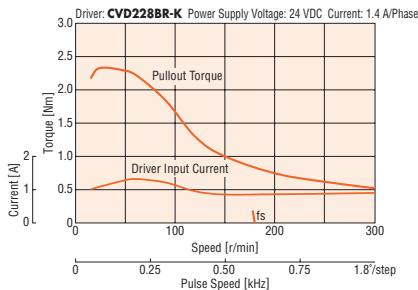

PKP268D28A2-R2EL/ PKP268D28A2-R2FL

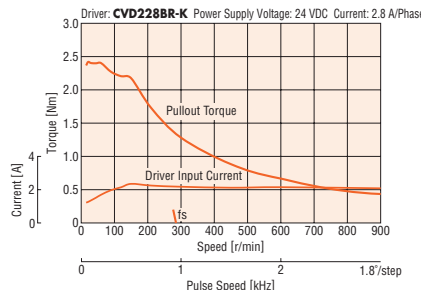

PKP268D42A2-R2EL/ PKP268D42A2-R2FL

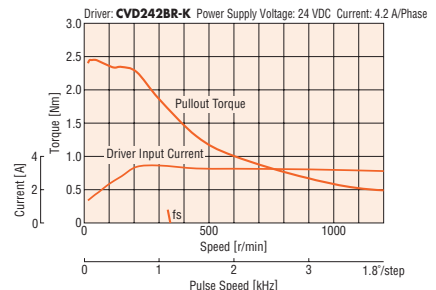

Note

● Data for the speed – torque characteristics is based on Oriental Motor's internal measurement conditions. If the conditions are changed, the characteristics may also change as a result.

● Depending on the driving conditions, a considerable amount of heat may be generated by the motor. To protect the encoder, be sure to keep the motor case temperature at 85°C max.

● The characteristics are the same when RS-485 communication type driver is used in combination.

Dimensions (Unit: mm)

● Motor

Product Name	L	Mass [kg]
PKP264D14A2-R2□L	55.5	0.45
PKP264D28A2-R2□L		
PKP264D42A2-R2□L		
PKP266D14A2-R2□L	70.5	0.7
PKP266D28A2-R2□L		
PKP266D42A2-R2□L		
PKP268D14A2-R2□L	92.5	1.1
PKP268D28A2-R2□L		
PKP268D42A2-R2□L		

● Either **E** (200 P/R) or **F** (400 P/R) indicating the encoder resolution is entered where the box □ is located within the product name.

● Applicable Connector

	Motor (HIROSE ELECTRIC CO., LTD.)	Encoder (Molex)
Connector Housing	MDF97A-5S-3.5C	51021-0800
Contact	MDF97-22SC	50079-8100
Crimping Tool	HT801/MDF97-22S	57177-5000

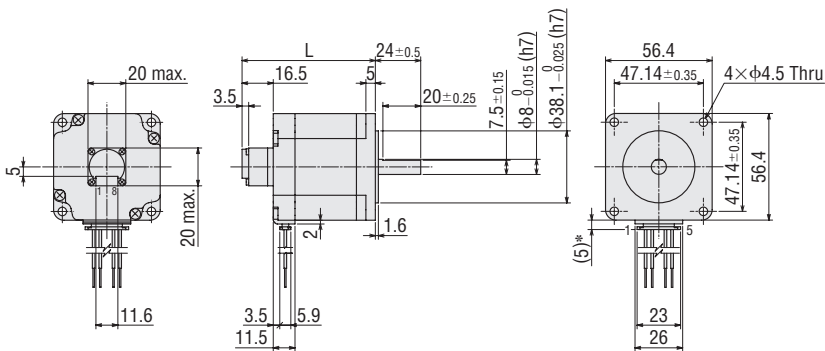

*With connection cable

● Connection Cable (Sold separately)

◇ Motor Connection Cable

Product Name	Length L [m]
LC2B06E	0.6
LC2B10E	1

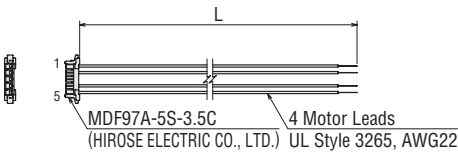

◇ Encoder Connection Cable

Product Name	Length L [m]
LCE08A-006	0.6

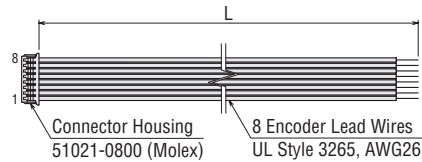

Inner Wiring Diagram of Motor

Wiring Diagram No.: Model A①

● See "Inner Wiring Diagram of Motor" page for the inner wiring diagram of the motor.

Standard Type with Encoder Frame Size 56.4 mm (Unipolar 5 lead wires)

Mini-Connector Type

13 mm

20 mm

28 mm

35 mm

42 mm

50 mm

51 mm

56.4 mm

60 mm

61 mm

85 mm

90 mm

Specifications

Product Name	Maximum Holding Torque [Nm]	Rotor Inertia J: kgm ²	Rated Current A/Phase	Voltage VDC	Winding Resistance Ω/Phase	Inductance mH/Phase	Basic Step Angle
PKP264U10A2-R2□L	0.58	140×10 ⁻⁷	1	4.4	4.4	6	1.8°
PKP264U20A2-R2□L			2	2.2	1.1	1.5	
PKP266U10A2-R2□L	1.1	270×10 ⁻⁷	1	6.9	6.9	11.6	
PKP266U20A2-R2□L			2	3.4	1.7	2.9	
PKP268U10A2-R2□L	2	500×10 ⁻⁷	1	9.9	9.9	18.4	
PKP268U20A2-R2□L			2	4.8	2.4	4.6	

● Either **E** (200 P/R) or **F** (400 P/R) indicating the encoder resolution is entered where the box □ is located within the product name.

● See "Common Specifications" page for encoder specifications.

*See "Drivers for 2-Phase / 5-Phase Motors" page for details on the recommended drivers.

Note

● Be sure to set the driver current at or below the motor rated current. If the motor rated current is exceeded, the product will be damaged.

Speed – Torque Characteristics (Reference values) fs: Max. Starting Frequency

PKP264U10A2-R2EL/PKP264U10A2-R2FL

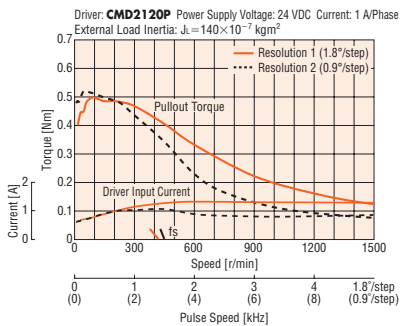

PKP266U10A2-R2EL/PKP266U10A2-R2FL

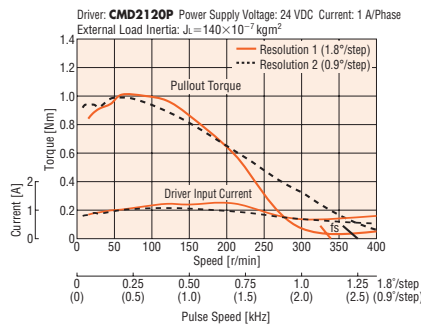

PKP268U10A2-R2EL/PKP268U10A2-R2FL

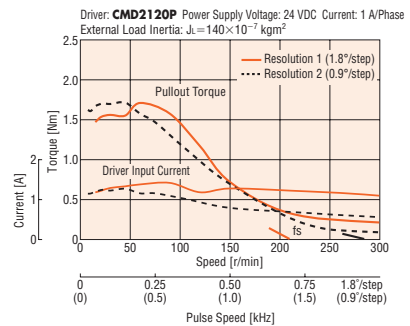

PKP264U20A2-R2EL/PKP264U20A2-R2FL

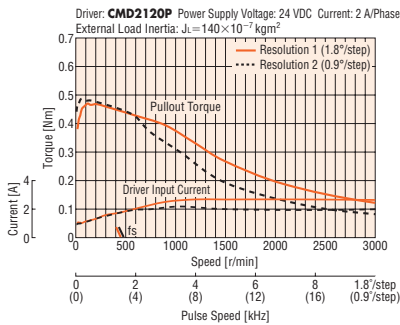

PKP266U20A2-R2EL/PKP266U20A2-R2FL

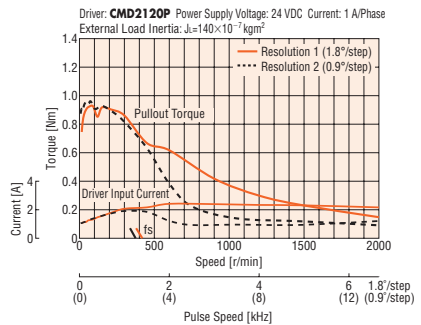

PKP268U20A2-R2EL/PKP268U20A2-R2FL

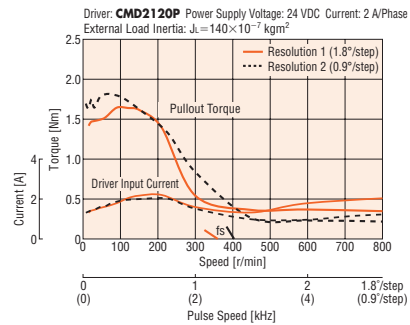

Note

● Data for the speed – torque characteristics is based on Oriental Motor's internal measurement conditions. If the conditions are changed, the characteristics may also change as a result.

● The data in the speed – torque characteristics represents the use of an external load inertia.

● Depending on the driving conditions, a considerable amount of heat may be generated by the motor. To protect the encoder, be sure to keep the motor case temperature at 85°C max.

Dimensions (Unit: mm)

● Motor

Product Name	L	Mass [kg]
PKP264U10A2-R2□L	55.5	0.45
PKP264U20A2-R2□L		
PKP266U10A2-R2□L	70.5	0.7
PKP266U20A2-R2□L		
PKP268U10A2-R2□L	92.5	1.1
PKP268U20A2-R2□L		

● Either **E** (200 P/R) or **F** (400 P/R) indicating the encoder resolution is entered where the box □ is located within the product name.

● Applicable Connector

	Motor (HIROSE ELECTRIC CO., LTD.)	Encoder (Molex)
Connector Housing	MDF97A-5S-3.5C	51021-0800
Contact	MDF97-22SC	50079-8100
Crimping Tool	HT801/MDF97-22S	57177-5000

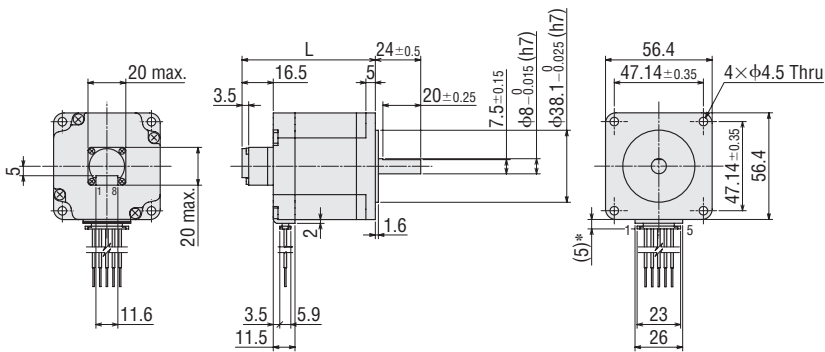

*With connection cable

● Connection Cable (Sold separately)

◇ Motor Connection Cable

Product Name	Length L [m]
LC2U06E	0.6
LC2U10E	1

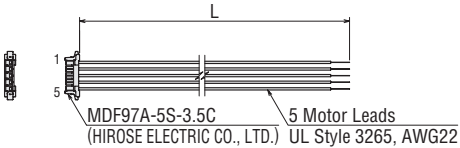

◇ Encoder Connection Cable

Product Name	Length L [m]
LCE08A-006	0.6

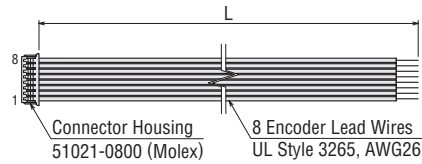

Inner Wiring Diagram of Motor

Wiring Diagram No.: Model A②

● See "Inner Wiring Diagram of Motor" page for the inner wiring diagram of the motor.

2-Phase
Motors
PKP

Features
Product
Line

Product
Number
Product Line

Standard
Type

High-
Resolution
Type

Flat
Type

SH Geared
Type

CS Geared
Type

Common
Specifications

Inner
Wiring
of Motor

5-Phase
Motors
PKP

Features
Product
Line

Product
Number
Product Line

Standard
Type

High-
Resolution
Type

TS Geared
Type

Common
Specifications

Motor
Pin
Arrangement

Drivers for
2-Phase/5-Phase
Motors

Peripheral
Equipment

Standard Type with Electromagnetic Brake Frame Size 56.4 mm (Bipolar 4 lead wires)

Mini-Connector Type

□13 mm

□20 mm

□28 mm

□35 mm

□42 mm

□50 mm

□51 mm

□56.4 mm

□60 mm

□61 mm

□85 mm

□90 mm

Specifications

Product Name	Maximum Holding Torque [Nm]	Rotor Inertia J: kgm ²	Rated Current A/Phase	Voltage VDC	Winding Resistance Ω/Phase	Inductance mH/Phase	Basic Step Angle	Electromagnetic Brake Static Friction Torque [Nm]
PKP264D28M2	0.74	270×10 ⁻⁷ *	2.8	1.6	0.57	1.5	1.8°	0.8
PKP266D28M2	1.4	400×10 ⁻⁷ *		2.4	0.86	2.9		
PKP268D28M2	2.5	630×10 ⁻⁷ *		3.4	1.2	4.6		

● Refer to the common specification page for electromagnetic brake specifications.

* This value is including the electromagnetic brake inertia.

Note

● Be sure to set the driver current at or below the motor rated current. If the motor rated current is exceeded, the product will be damaged.

Speed – Torque Characteristics (Reference values) fs: Max. Starting Frequency

PKP264D28M2

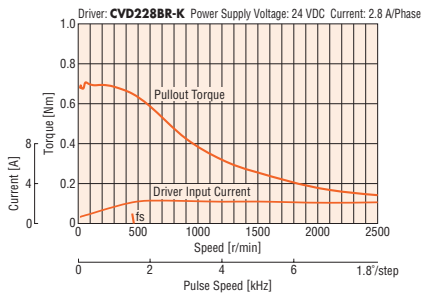

PKP266D28M2

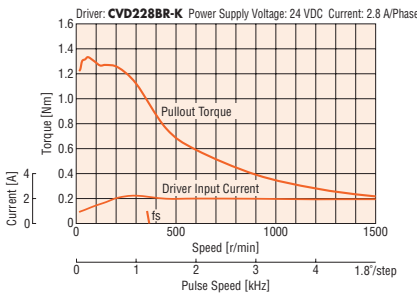

PKP268D28M2

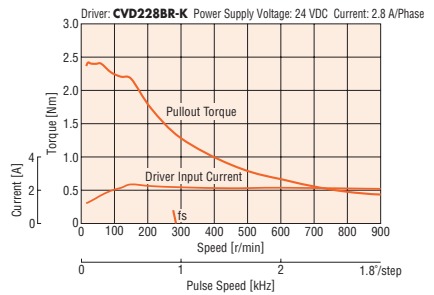

Note

● Data for the speed – torque characteristics is based on Oriental Motor's internal measurement conditions. If the conditions are changed, the characteristics may also change as a result.

● Depending on the driving conditions, a considerable amount of heat may be generated by the motor. Be sure to keep the motor case temperature at 100°C max.

● The characteristics are the same when RS-485 communication type driver is used in combination.

Dimensions (Unit: mm)

Motor

Product Name	L1	L2	Mass [kg]
PKP264D28M2	73.5	55.3	0.65
PKP266D28M2	88.5	70.3	0.9
PKP268D28M2	110.5	92.3	1.3

● Applicable Connector

	Motor (HIROSE ELECTRIC CO., LTD.)	Electromagnetic Brake (HIROSE ELECTRIC CO., LTD.)
Connector Housing	MDF97A-5S-3.5C	DF62C-2S-2.2C
Contact	MDF97-22SC	DF62-22SCA
Crimping Tool	HT801/MDF97-22S	HT801/DF62-22(10)

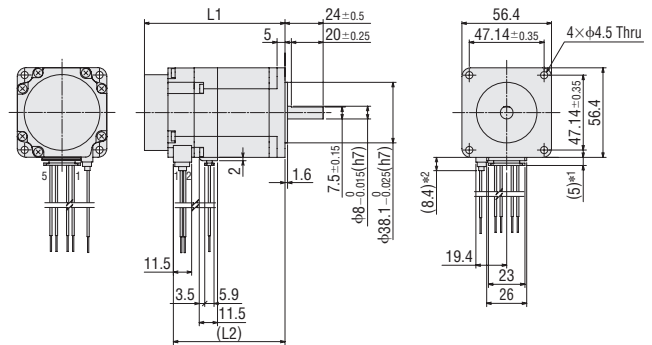

*1 With connection cable

*2 With electromagnetic brake connection cable

Connection Cable (Sold separately)

◇ Motor Connection Cable

Product Name	Length L [m]
LC2B06E	0.6
LC2B10E	1

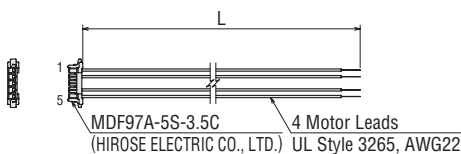

◇ Electromagnetic Brake Connection Cable

Product Name	Length L [m]
LCM02A-006	0.6
LCM02A-010	1

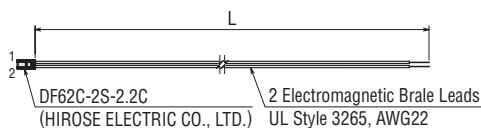

Inner Wiring Diagram of Motor

Wiring Diagram No.: Model A①

● See "Inner Wiring Diagram of Motor" page for the inner wiring diagram of the motor.

Standard Type with Electromagnetic Brake Frame Size 56.4 mm (Unipolar 6 lead wires)

Connector Type

Specifications

Product Name	Maximum Holding Torque [Nm]	Rotor Inertia J: kgm ²	Rated Current A/Phase	Voltage VDC	Winding Resistance Ω/Phase	Inductance mH/Phase	Basic Step Angle	Electromagnetic Brake Static Friction Torque [Nm]
PKP264U20M	0.51	270×10 ⁻⁷ *	2	2.9	1.45	1.8	1.8°	1.5
PKP266U20M	1.1	440×10 ⁻⁷ *		4	2	2.9		
PKP268U20M	1.75	640×10 ⁻⁷ *		4.9	2.45	4.4		

● Refer to the common specification page for electromagnetic brake specifications.

* This value is including the electromagnetic brake inertia.

Note

● Be sure to set the driver current at or below the motor rated current. If the motor rated current is exceeded, the product will be damaged.

Speed – Torque Characteristics (Reference values) fs: Max. Starting Frequency

PKP264U20M

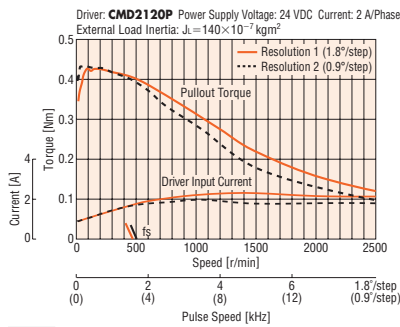

PKP266U20M

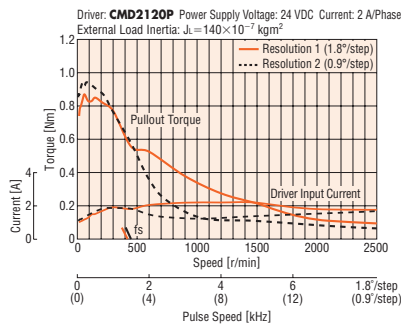

PKP268U20M

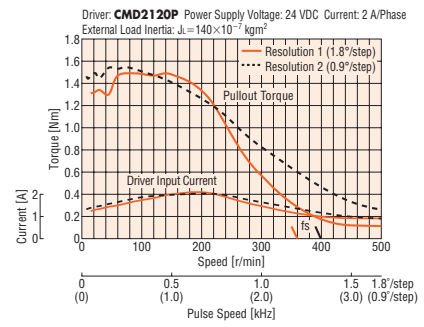

Note

● Data for the speed – torque characteristics is based on Oriental Motor's internal measurement conditions. If the conditions are changed, the characteristics may also change as a result.

● The data in the speed – torque characteristics represents the use of an external load inertia.

● Depending on the driving conditions, a considerable amount of heat may be generated by the motor. Be sure to keep the motor case temperature at 100°C max.

Dimensions (Unit: mm)

Motor

Product Name	L	Mass [kg]
PKP264U20M	75.5	0.76
PKP266U20M	90.5	1.03
PKP268U20M	112.5	1.4

● Applicable Connector (Molex)

Connector Housing: 51067-0600
Contact: 50217-9101
Crimp Tool: 57189-5000
57190-5000

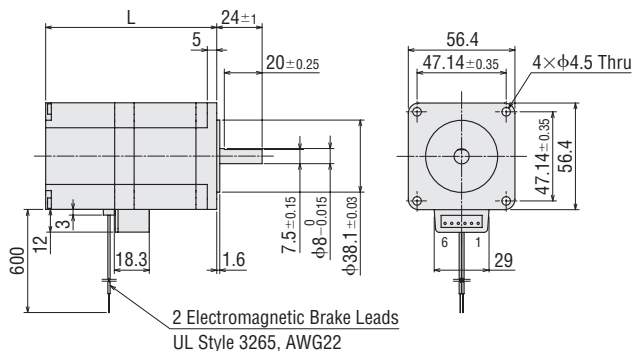

Inner Wiring Diagram of Motor

Wiring Diagram No.: Model B④

● See "Inner Wiring Diagram of Motor" page for the inner wiring diagram of the motor.

Connection Cable (Sold separately)

Motor Connection Cable

Product Name	Length L [m]
LC2U06C	0.6
LC2U10C	1

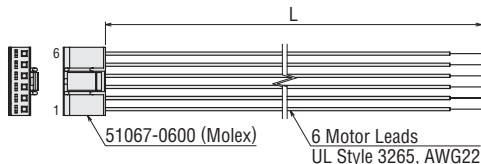

2-Phase Motors PKP

Features Product Line

Product Number Product Line

Standard Type

High-Resolution Type

Flat Type

SH Geared Type

CS Geared Type

Common Specifications

Inner Wiring of Motor

5-Phase Motors PKP

Features Product Line

Product Number Product Line

Standard Type

High-Resolution Type

TS Geared Type

Common Specifications

Motor Pin Arrangement

Drivers for 2-Phase/5-Phase Motors

Peripheral Equipment

Standard Type Frame Size 60 mm (Bipolar 4 lead wires)

Lead Wire Type

13 mm

20 mm

28 mm

35 mm

42 mm

50 mm

51 mm

56.4 mm

60 mm

61 mm

85 mm

90 mm

Specifications

Product Name	Maximum Holding Torque [Nm]	Rotor Inertia J: kgm ²	Rated Current A/Phase	Voltage VDC	Winding Resistance Ω/Phase	Inductance mH/Phase	Basic Step Angle
PK264JD□	1.06	280×10 ⁻⁷	2.8	2.1	0.73	1.8	1.8°
PK266JD□	1.75	450×10 ⁻⁷		2.8	1	3.05	
PK267JD□	2.2	570×10 ⁻⁷		3.4	1.2	3.54	
PK269JD□	3.1	900×10 ⁻⁷		4.2	1.49	5.7	

● The box □ in the product name indicates the shaft **A** (single shaft) or **B** (double shaft).

Note

● Be sure to set the driver current at or below the motor rated current. If the motor rated current is exceeded, the product will be damaged.

Speed – Torque Characteristics (Reference values) fs: Max. Starting Frequency

PK264JDA/PK264JDB

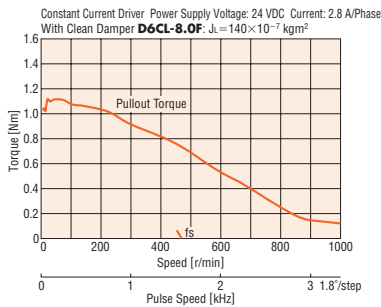

PK266JDA/PK266JDB

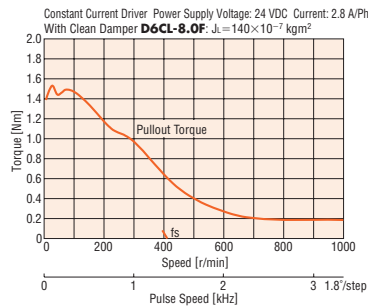

PK267JDA/PK267JDB

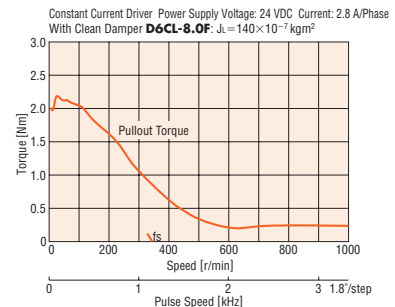

PK269JDA/PK269JDB

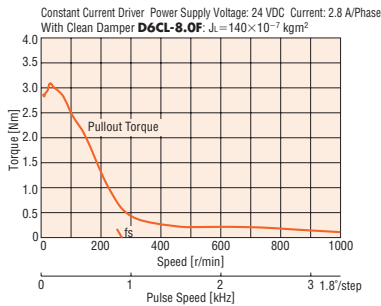

Note

- Data for the speed – torque characteristics is based on Oriental Motor's internal measurement conditions. If the conditions are changed, the characteristics may also change as a result.
- If there is a "clean damper" entry in the speed – torque characteristics, the data is for a double shaft motor when a clean damper is equipped.
- Depending on the driving conditions, a considerable amount of heat may be generated by the motor. Be sure to keep the motor case temperature at 100°C max.

Dimensions (Unit: mm)

Motor

Product Name	L1	L2	Mass [kg]
PK264JDA	43.5	—	0.6
PK264JDB		66.5	
PK266JDA	54	—	0.83
PK266JDB		77	
PK267JDA	65	—	1.02
PK267JDB		88	
PK269JDA	85	—	1.43
PK269JDB		108	

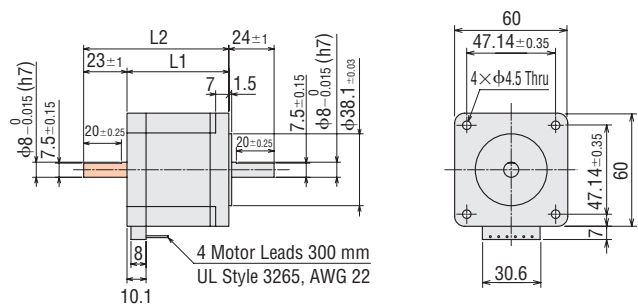

- These dimensions are for double shaft motors. For single shaft motors, ignore the shaded areas.

Inner Wiring Diagram of Motor

Wiring Diagram No.: Model C⑤

- See "Inner Wiring Diagram of Motor" page for the inner wiring diagram of the motor.

Standard Type Frame Size 60 mm (Unipolar 6 lead wires)

Lead Wire Type

Specifications

Product Name	Maximum Holding Torque [Nm]	Rotor Inertia J: kgm ²	Rated Current A/Phase	Voltage VDC	Winding Resistance Ω/Phase	Inductance mH/Phase	Basic Step Angle
PK264J□	0.75	280×10 ⁻⁷	2	2.9	1.46	1.8	1.8°
PK266J□	1.35	450×10 ⁻⁷		4	2	3.05	
PK267J□	1.7	570×10 ⁻⁷		4.8	2.4	3.54	
PK269J□	2.2	900×10 ⁻⁷		6	2.98	5.7	

● The box □ in the product name indicates the shaft **A** (single shaft) or **B** (double shaft).

Note

● Be sure to set the driver current at or below the motor rated current. If the motor rated current is exceeded, the product will be damaged.

Speed – Torque Characteristics (Reference values) fs: Max. Starting Frequency

PK264JA/PK264JB

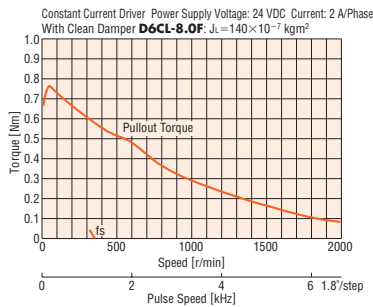

PK266JA/PK266JB

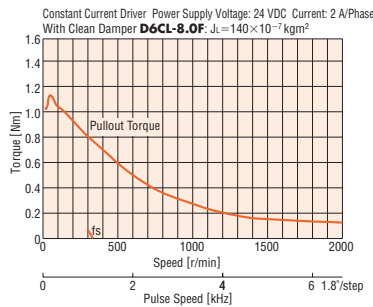

PK267JA/PK267JB

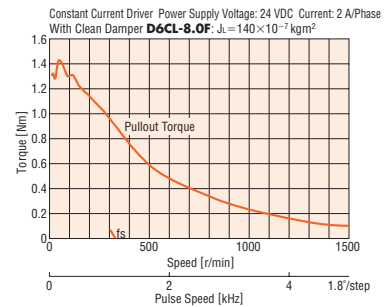

PK269JA/PK269JB

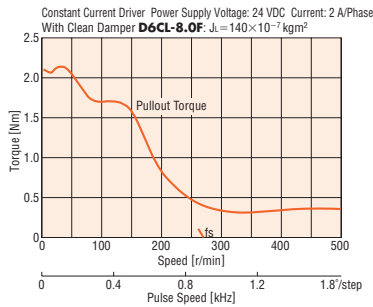

Note

- Data for the speed – torque characteristics is based on Oriental Motor's internal measurement conditions. If the conditions are changed, the characteristics may also change as a result.
- If there is a "clean damper" entry in the speed – torque characteristics, the data is for a double shaft motor when a clean damper is equipped.
- Depending on the driving conditions, a considerable amount of heat may be generated by the motor. Be sure to keep the motor case temperature at 100°C max.

Dimensions (Unit: mm)

Motor

Product Name	L1	L2	Mass [kg]
PK264JA	43.5	—	0.6
PK264JB		66.5	
PK266JA	54	—	0.83
PK266JB		77	
PK267JA	65	—	1.02
PK267JB		88	
PK269JA	85	—	1.43
PK269JB		108	

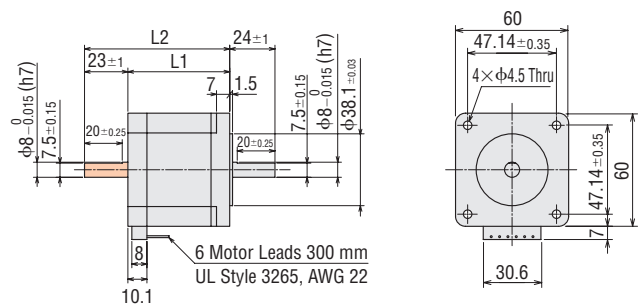

- These dimensions are for double shaft motors.
For single shaft motors, ignore the shaded areas.

Inner Wiring Diagram of Motor

Wiring Diagram No.: Model C⑦

- See "Inner Wiring Diagram of Motor" page for the inner wiring diagram of the motor.

2-Phase Motors PKP

Features Product Line

Product Number Product Line

Standard Type

High-Resolution Type

Flat Type

SH Geared Type

CS Geared Type

Common Specifications

Inner Wiring of Motor

5-Phase Motors PKP

Features Product Line

Product Number Product Line

Standard Type

High-Resolution Type

TS Geared Type

Common Specifications

Motor Pin Arrangement

Drivers for 2-Phase/5-Phase Motors

Peripheral Equipment

- Motor Frame Size
- 13 mm
- 20 mm
- 28 mm
- 35 mm
- 42 mm
- 50 mm
- 51 mm
- 56.4 mm
- 60 mm
- 61 mm
- 85 mm
- 90 mm

Standard Type Frame Size 85 mm (Bipolar 4 lead wires)

Lead Wire Type

Specifications

Product Name	Maximum Holding Torque [Nm]	Rotor Inertia J: kgm ²	Rated Current A/Phase	Voltage VDC	Winding Resistance Ω/Phase	Inductance mH/Phase	Basic Step Angle	Recommended Driver Product Name*
PKP296D45□	3.3	1100×10 ⁻⁷	4.5	1.9	0.42	3.1	1.8°	CVD245BR-K
PKP296D63□			6.3	1.4	0.23	1.6		-
PKP299D45□	6.4	2200×10 ⁻⁷	4.5	2.7	0.6	5.4		CVD245BR-K
PKP299D63□			6.3	2	0.32	2.6		-
PKP2913D45□	9.5	3400×10 ⁻⁷	4.5	3.5	0.78	6.9		CVD245BR-K
PKP2913D56□			5.6	2.6	0.47	4.4		-

● The box □ in the product name indicates the shaft **A** (single shaft) or **B** (double shaft).

*See "Drivers for 2-Phase / 5-Phase Motors" page for drivers that can be used in combination.

Note

● Be sure to set the driver current at or below the motor rated current. If the motor rated current is exceeded, the product will be damaged.

Speed – Torque Characteristics (Reference values) fs: Max. Starting Frequency

PKP296D45A/PKP296D45B

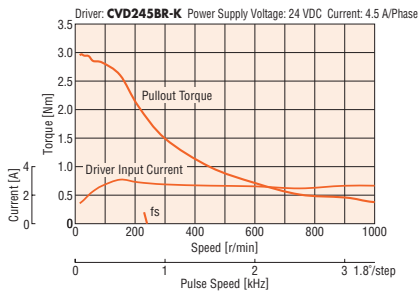

PKP299D45A/PKP299D45B

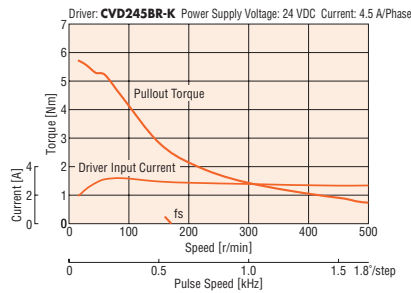

PKP2913D45A/PKP2913D45B

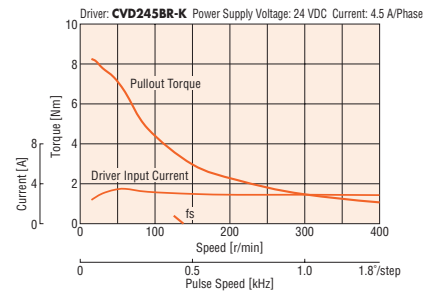

PKP296D63A/PKP296D63B

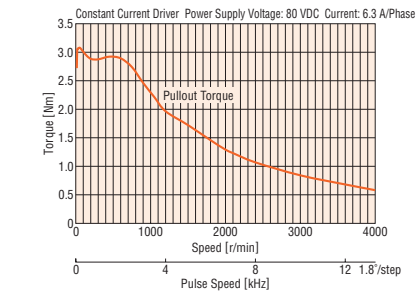

PKP299D63A/PKP299D63B

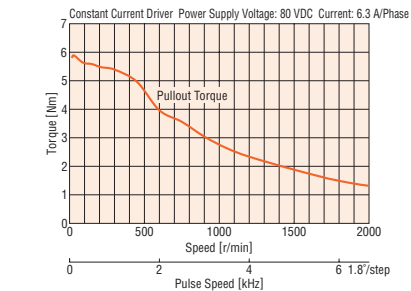

PKP2913D56A/PKP2913D56B

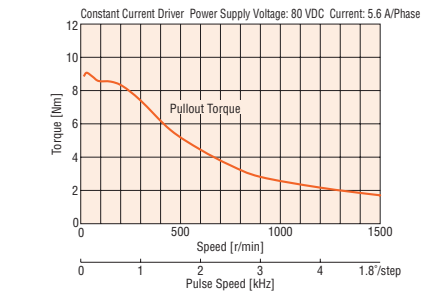

Note

- Data for the speed – torque characteristics is based on Oriental Motor's internal measurement conditions. If the conditions are changed, the characteristics may also change as a result.
- Depending on the driving conditions, a considerable amount of heat may be generated by the motor. Be sure to keep the motor case temperature at 100°C max.

Dimensions (Unit: mm)

Motor

Product Name	L1	L2	Mass [kg]
PKP296D45A	66	-	1.8
PKP296D45B		100	
PKP296D63A		-	
PKP296D63B	100		
PKP299D45A	96	-	2.9
PKP299D45B		130	
PKP299D63A		-	
PKP299D63B	130		
PKP2913D45A	126	-	4
PKP2913D45B		160	
PKP2913D56A		-	
PKP2913D56B	160		

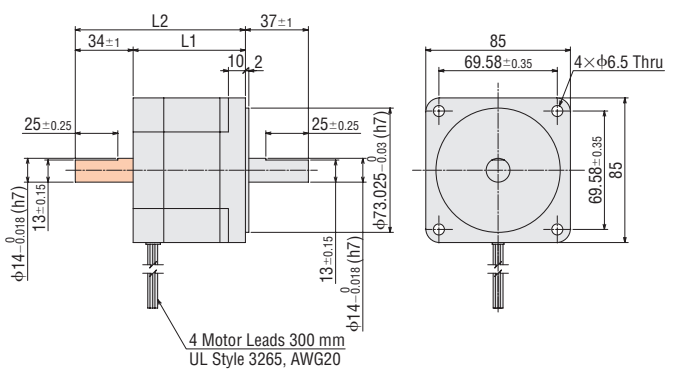

● These dimensions are for double shaft motors.
For single shaft motors, ignore the shaded areas.

Inner Wiring Diagram of Motor

Wiring Diagram No.: Model C⑤

● See "Inner Wiring Diagram of Motor" page for the inner wiring diagram of the motor.

Standard Type Frame Size 85 mm (Unipolar 6 lead wires)

Lead Wire Type

Specifications

Product Name	Maximum Holding Torque [Nm]	Rotor Inertia J: kgm ²	Rated Current A/Phase	Voltage VDC	Winding Resistance Ω/Phase	Inductance mH/Phase	Basic Step Angle
PKP296U20□	2.6	1100×10 ⁻⁷	2	4.4	2.2	7.8	1.8°
PKP296U30□			3	3	1.0	3.5	
PKP296U45□			4.5	2	0.45	1.6	
PKP299U20□	5.0	2200×10 ⁻⁷	2	6.4	3.2	13.2	
PKP299U30□			3	4.5	1.5	6	
PKP299U45□			4.5	2.8	0.63	2.6	
PKP2913U20□	7.3	3400×10 ⁻⁷	2	7.6	3.8	18	
PKP2913U40□			4	3.8	0.94	4.4	

● The box □ in the product name indicates the shaft **A** (single shaft) or **B** (double shaft).

Note

● Be sure to set the driver current at or below the motor rated current. If the motor rated current is exceeded, the product will be damaged.

Speed – Torque Characteristics (Reference values) fs: Max. Starting Frequency

PKP296U20A/PKP296U20B

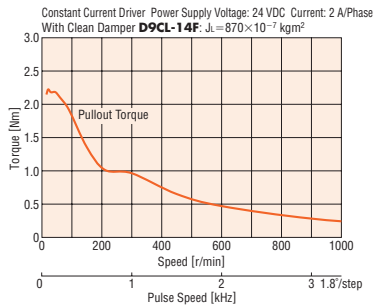

PKP299U20A/PKP299U20B

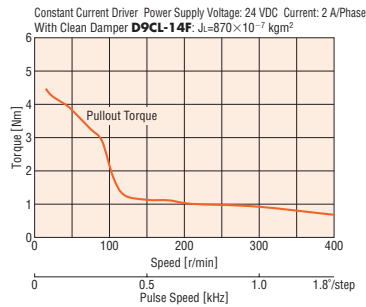

PKP2913U20A/PKP2913U20B

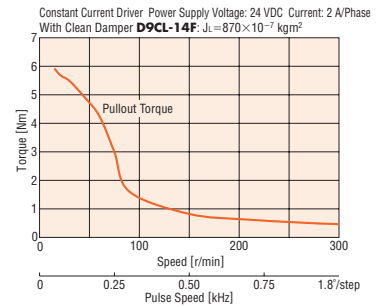

PKP296U30A/PKP296U30B

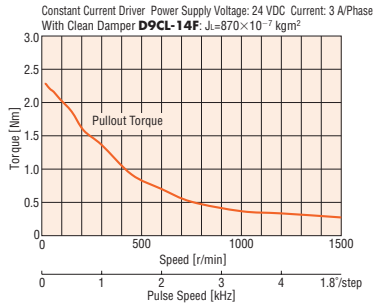

PKP299U30A/PKP299U30B

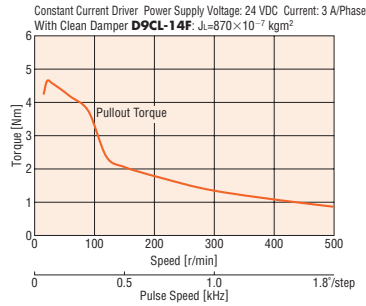

PKP2913U40A/PKP2913U40B

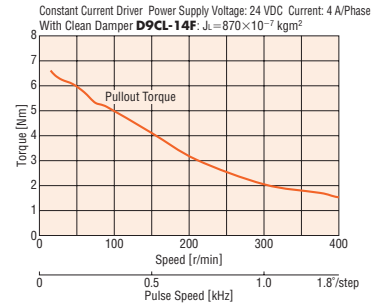

PKP296U45A/PKP296U45B

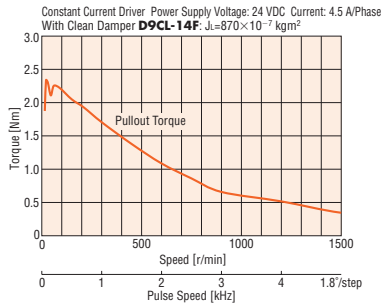

PKP299U45A/PKP299U45B

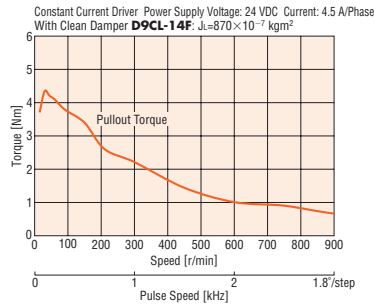

Note

- Data for the speed – torque characteristics is based on Oriental Motor's internal measurement conditions. If the conditions are changed, the characteristics may also change as a result.
- If there is a "clean damper" entry in the speed – torque characteristics, the data is for a double shaft motor when a clean damper is equipped.
- Depending on the driving conditions, a considerable amount of heat may be generated by the motor. Be sure to keep the motor case temperature at 100°C max.

2-Phase Motors PKP

Features Product Line

Product Number Product Line

Standard Type

High-Resolution Type

Flat Type

SH Geared Type

CS Geared Type

Common Specifications

Inner Wiring of Motor

5-Phase Motors PKP

Features Product Line

Product Number Product Line

Standard Type

High-Resolution Type

TS Geared Type

Common Specifications

Motor Pin Arrangement

Drivers for 2-Phase/5-Phase Motors

Peripheral Equipment

- Motor Frame Size
- 13 mm
 - 20 mm
 - 28 mm
 - 35 mm
 - 42 mm
 - 50 mm
 - 51 mm
 - 56.4 mm
 - 60 mm
 - 61 mm
 - 85 mm
 - 90 mm

Dimensions (Unit: mm)

Motor

Product Name	L1	L2	Mass [kg]
PKP296U20A	66	-	1.8
PKP296U20B		100	
PKP296U30A		-	
PKP296U30B		100	
PKP296U45A		-	
PKP296U45B	100		
PKP299U20A	96	-	2.9
PKP299U20B		130	
PKP299U30A		-	
PKP299U30B		130	
PKP299U45A		-	
PKP299U45B	130		
PKP2913U20A	126	-	4
PKP2913U20B		160	
PKP2913U40A		-	
PKP2913U40B		160	

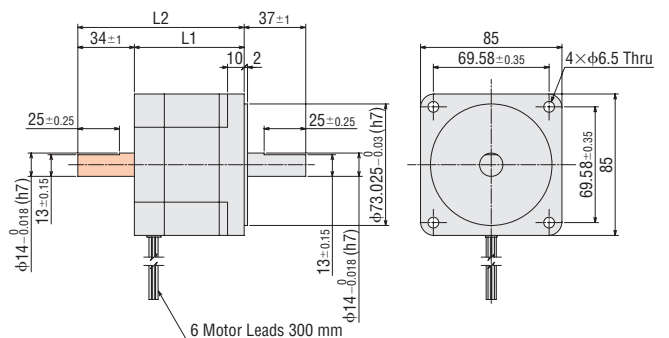

● These dimensions are for double shaft motors.
For single shaft motors, ignore the shaded areas.

Inner Wiring Diagram of Motor

Wiring Diagram No.: Model C⑦

● See "Inner Wiring Diagram of Motor" page for the inner wiring diagram of the motor.

2-Phase
Motors
PKP

Features
Product
Line

Product
Number
Product Line

Standard
Type

High-
Resolution
Type

Flat
Type

SH Geared
Type

CS Geared
Type

Common
Specifications

Inner
Wiring
of Motor

5-Phase
Motors
PKP

Features
Product
Line

Product
Number
Product Line

Standard
Type

High-
Resolution
Type

TS Geared
Type

Common
Specifications

Motor
Pin
Arrangement

Drivers for
2-Phase/5-Phase
Motors

Peripheral
Equipment

High-Resolution Type Frame Size 28 mm (Bipolar 4 lead wires)

Connector Type

13 mm

20 mm

28 mm

35 mm

42 mm

50 mm

51 mm

56.4 mm

60 mm

61 mm

85 mm

90 mm

Specifications

Product Name	Maximum Holding Torque [Nm]	Rotor Inertia J: kgm ²	Rated Current A/Phase	Voltage VDC	Winding Resistance Ω/Phase	Inductance mH/Phase	Basic Step Angle
PKP223MD15□	0.086	8.6×10 ⁻⁷	1.5	1.77	1.18	1.3	0.9°
PKP225MD15□	0.165	17×10 ⁻⁷		3	2	2.7	

● The box □ in the product name indicates the shaft **A** (single shaft) or **B** (double shaft).

*See "Drivers for 2-Phase / 5-Phase Motors" page for drivers that can be used in combination.

Note

● Set the current of the driver so that it does not exceed the rated current of the motor. If the current of the driver exceeds the rated current of the motor, it may cause damage to the product.

Speed – Torque Characteristics (Reference values) fs: Max. Starting Frequency

PKP223MD15A/PKP223MD15B

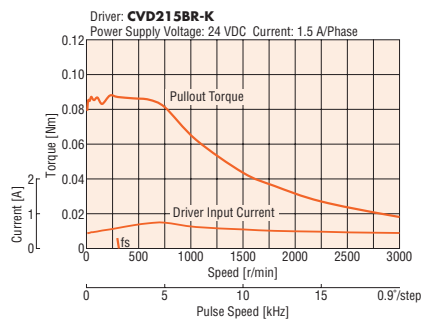

PKP225MD15A/PKP225MD15B

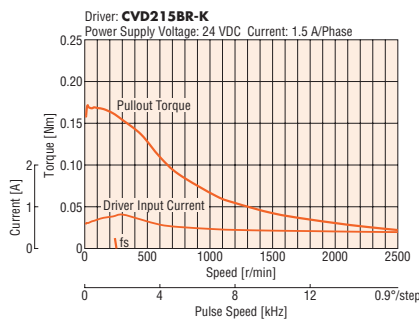

Note

● Data for the speed – torque characteristics is based on Oriental Motor's internal measurement conditions. If the conditions are changed, the characteristics may also change as a result.

● Depending on the driving conditions, a considerable amount of heat may be generated by the motor. Be sure to keep the motor case temperature at 100°C or less.

● The characteristics are the same when RS-485 communication type driver is used in combination.

Dimensions (Unit: mm)

Motors

Product Name	L1	L2	Mass [kg]
PKP223MD15A	32	—	0.11
PKP223MD15B		42	
PKP225MD15A	51.5	—	0.2
PKP225MD15B		61.5	

Applicable Connectors

Connector Housing: 51065-0600 (Molex)

Contact: 50212-8100 (Molex)

Crimp Tool: 57176-5000 (Molex)

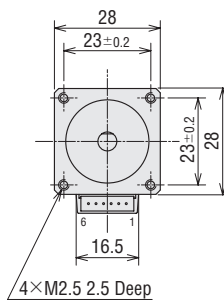
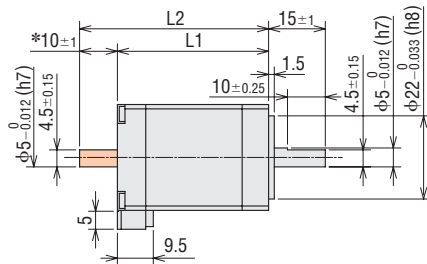

*The length of the shaft flat on the double shaft model is 10±0.25.

● These dimensions are for double shaft motors.

For single shaft motors, ignore the shaded areas.

Connection Cables (Sold separately)

Motor Connection Cable

Product Name	Length L [m]
LC2B06A	0.6
LC2B10A	1

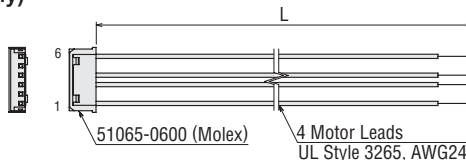

Inner Wiring Diagram of Motor

Wiring Diagram No.: Model B③

● See "Inner Wiring Diagram of Motor" page for the inner wiring diagram of the motor.

High-Resolution Type Frame Size 28 mm (Unipolar 6 lead wires) Connector Type

Specifications

Product Name	Maximum Holding Torque [Nm]	Rotor Inertia J: kgm ²	Rated Current A/Phase	Voltage VDC	Winding Resistance Ω/Phase	Inductance mH/Phase	Basic Step Angle
PKP223MU09□	0.07	8.6×10 ⁻⁷	0.95	2.95	3.11	1.9	0.9°
PKP225MU09□	0.124	17×10 ⁻⁷		4.4	4.6	3.2	

● The box □ in the product name indicates the shaft **A** (single shaft) or **B** (double shaft).

*See "Drivers for 2-Phase / 5-Phase Motors" page for details on the recommended drivers.

Note

● Set the current of the driver so that it does not exceed the rated current of the motor. If the current of the driver exceeds the rated current of the motor, it may cause damage to the product.

Speed – Torque Characteristics (Reference values) fs: Max. Starting Frequency

PKP223MU09A/PKP223MU09B

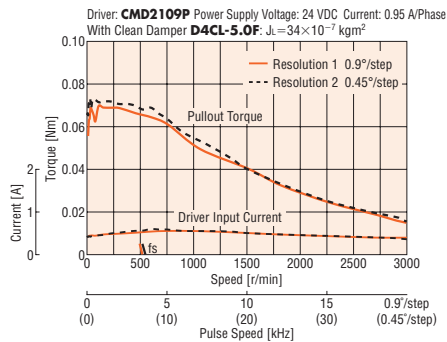

PKP225MU09A/PKP225MU09B

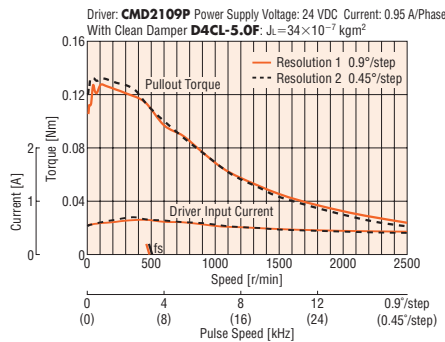

Note

● Data for the speed – torque characteristics is based on Oriental Motor's internal measurement conditions. If the conditions are changed, the characteristics may also change as a result.

● If there is a "clean damper" entry in the speed – torque characteristics, the data is for a double shaft motor when a clean damper is equipped.

● Depending on the driving conditions, a considerable amount of heat may be generated by the motor. Be sure to keep the motor case temperature at 100°C or less.

Dimensions (Unit: mm)

Motors

Product Name	L1	L2	Mass [kg]
PKP223MU09A	32	–	0.11
PKP223MU09B		42	
PKP225MU09A	51.5	–	0.2
PKP225MU09B		61.5	

Applicable Connectors

Connector Housing: 51065-0600 (Molex)

Contact: 50212-8100 (Molex)

Crimp Tool: 57176-5000 (Molex)

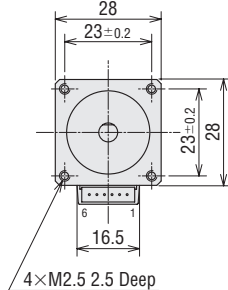
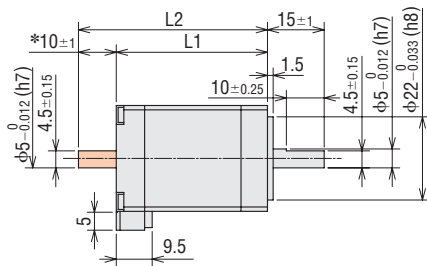

*The length of the shaft flat on the double shaft model is 10±0.25.

● These dimensions are for double shaft motors.

For single shaft motors, ignore the shaded areas.

Connection Cables (Sold separately)

◇ Motor Connection Cable

Product Name	Length L [m]
LC2U06A	0.6
LC2U10A	1

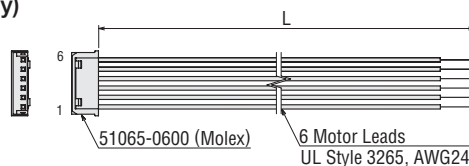

Inner Wiring Diagram of Motor

Wiring Diagram No.: Model B④

● See "Inner Wiring Diagram of Motor" page for the inner wiring diagram of the motor.

2-Phase
Motors
PKP

Features
Product
Line

Product
Number
Product Line

Standard
Type

High-
Resolution
Type

Flat
Type

SH Geared
Type

CS Geared
Type

Common
Specifications

Inner
Wiring
of Motor

5-Phase
Motors
PKP

Features
Product
Line

Product
Number
Product Line

Standard
Type

High-
Resolution
Type

TS Geared
Type

Common
Specifications

Motor
Pin
Arrangement

Drivers for
2-Phase/5-Phase
Motors

Peripheral
Equipment

High-Resolution Type Frame Size 42 mm (Bipolar 4 lead wires)

Mini-Connector Type

Specifications

Product Name	Maximum Holding Torque [Nm]	Rotor Inertia J: kgm ²	Rated Current A/Phase	Voltage VDC	Winding Resistance Ω/Phase	Inductance mH/Phase	Basic Step Angle	Recommended Driver Product Name*
PKP243MD15□2	0.32	39×10 ⁻⁷	1.5	2.7	1.8	5.1	0.9°	CVD223FBR-K
PKP244MD15□2	0.42	58×10 ⁻⁷		3.2	2.1	6		
PKP245MD15□2	0.61	78×10 ⁻⁷		3	2	6.6		
PKP246MD15□2	0.82	116×10 ⁻⁷		3.9	2.6	9		

● The box □ in the product name indicates the shaft **A** (single shaft) or **B** (double shaft).

*See "Drivers for 2-Phase / 5-Phase Motors" page for drivers that can be used in combination.

Note

● Be sure to set the driver current at or below the motor rated current. If the motor rated current is exceeded, the product will be damaged.

Speed – Torque Characteristics (Reference values) fs: Max. Starting Frequency

PKP243MD15A2/ PKP243MD15B2

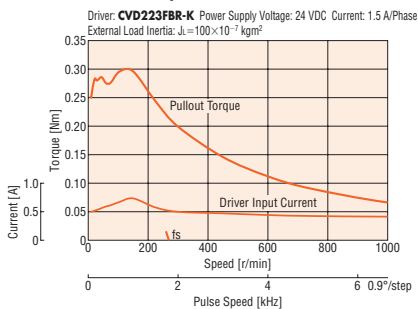

PKP244MD15A2/ PKP244MD15B2

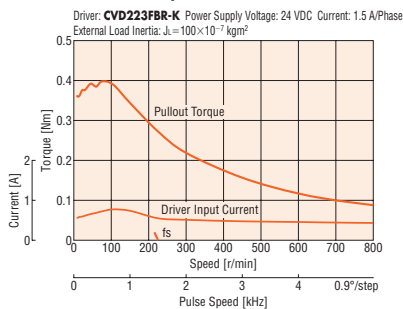

PKP245MD15A2/ PKP245MD15B2

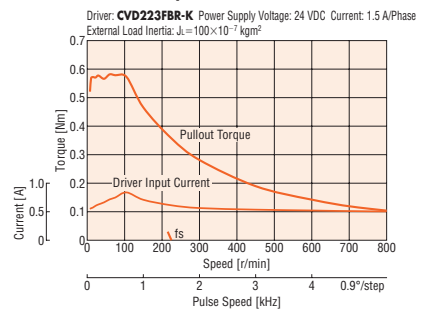

PKP246MD15A2/ PKP246MD15B2

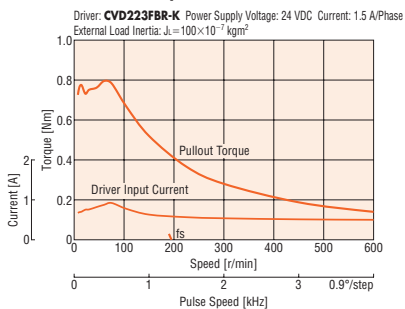

Note

- Data for the speed – torque characteristics is based on Oriental Motor's internal measurement conditions. If the conditions are changed, the characteristics may also change as a result.
- The data in the speed – torque characteristics represents the use of an external load inertia.
- Depending on the driving conditions, a considerable amount of heat may be generated by the motor. Be sure to keep the motor case temperature at 100°C or less.
- The characteristics are the same when RS-485 communication type driver is used in combination.

Dimensions (Unit: mm)

Motors

Product Name	L1	L2	Mass [kg]
PKP243MD15A2	33	—	0.23
PKP243MD15B2		48	
PKP244MD15A2	39	—	0.3
PKP244MD15B2		54	
PKP245MD15A2	47	—	0.37
PKP245MD15B2		62	
PKP246MD15A2	59	—	0.5
PKP246MD15B2		74	

Applicable Connectors

Connector Housing: MDF97A-5S-3.5C (HIROSE ELECTRIC CO., LTD.)

Contact: MDF97-22SC (HIROSE ELECTRIC CO., LTD.)

Crimp Tool: HT801/MDF97-22S (HIROSE ELECTRIC CO., LTD.)

Connection Cables (Sold separately)

Motor Connection Cable

Product Name	Length L [m]
LC2B06E	0.6
LC2B10E	1

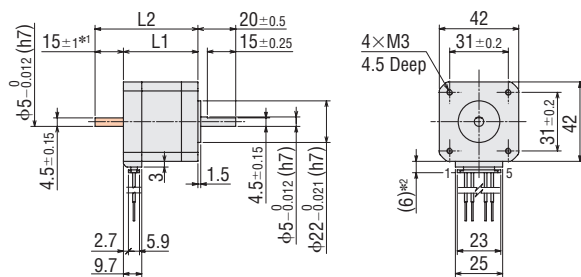
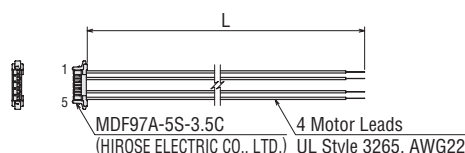

*1 The length of the shaft flat on the double shaft model is 15±0.25.

*2 With connection cable

● These dimensions are for double shaft motors.

For single shaft motors, ignore the shaded areas.

Inner Wiring Diagram of Motor

Wiring Diagram No.: Model A①

● See "Inner Wiring Diagram of Motor" page for the inner wiring diagram of the motor.

High-Resolution Type Frame Size 42 mm (Bipolar 4 lead wires)

Connector Type

Specifications

Product Name	Maximum Holding Torque [Nm]	Rotor Inertia J: kgm ²	Rated Current A/Phase	Voltage VDC	Winding Resistance Ω/Phase	Inductance mH/Phase	Basic Step Angle	Recommended Driver Product Name*
PKP243MD15□	0.30	36×10 ⁻⁷	1.5	2.85	1.9	6.6	0.9°	CVD215BR-K
PKP244MD15□	0.42	57×10 ⁻⁷		3.9	2.6	7.6		

● The box □ in the product name indicates the shaft **A** (single shaft) or **B** (double shaft).

*See "Drivers for 2-Phase / 5-Phase Motors" page for drivers that can be used in combination.

Note

● Be sure to set the driver current at or below the motor rated current. If the motor rated current is exceeded, the product will be damaged.

Speed – Torque Characteristics (Reference values) fs: Max. Starting Frequency

PKP243MD15A/PKP243MD15B

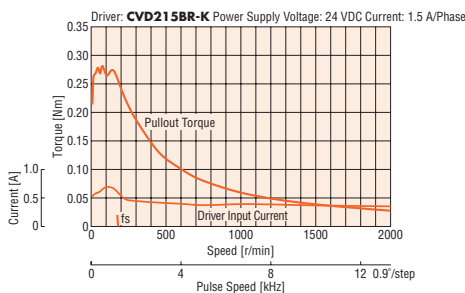

PKP244MD15A/PKP244MD15B

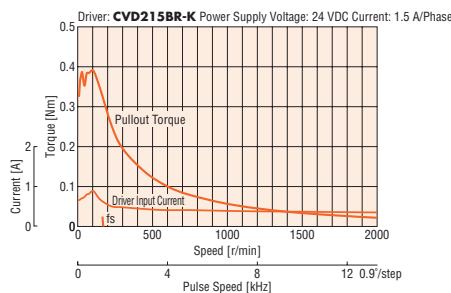

Note

● Data for the speed – torque characteristics is based on Oriental Motor's internal measurement conditions. If the conditions are changed, the characteristics may also change as a result.

● Depending on the driving conditions, a considerable amount of heat may be generated by the motor. Be sure to keep the motor case temperature at 100°C or less.

● The characteristics are the same if combined with an RS-485 communication type driver.

Dimensions (Unit: mm)

Motors

Product Name	L1	L2	Mass [kg]
PKP243MD15A	33	—	0.25
PKP243MD15B		48	
PKP244MD15A	39	—	0.3
PKP244MD15B		54	

● Applicable Connectors

Connector Housing: 51103-0600 (Molex)

Contact: 50351-8100 (Molex)

Crimp Tool: 57295-5000 (Molex)

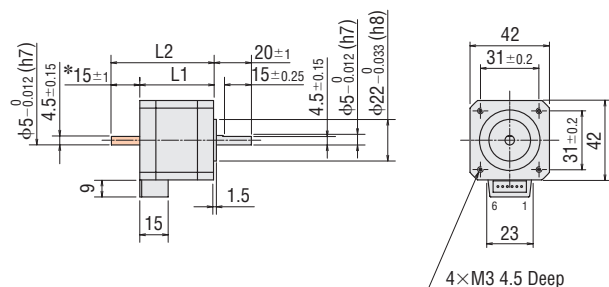

*The length of the shaft flat on the double shaft model is 15±0.25.

● These dimensions are for double shaft motors.

For single shaft motors, ignore the shaded areas.

Connection Cable (Sold separately)

Motor Connection Cable

Product Name	Length L [m]
LC2B06B	0.6
LC2B10B	1

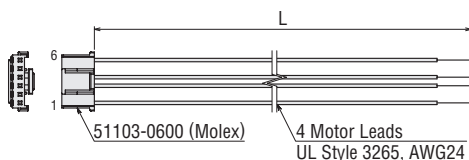

Inner Wiring Diagram of Motor

Wiring Diagram No.: Model B③

● Refer to the motor inner wiring page for an inner wiring diagram of the motor.

2-Phase Motors PKP

Features Product Line

Product Number Product Line

Standard Type

High-Resolution Type

Flat Type

SH Geared Type

CS Geared Type

Common Specifications

Inner Wiring of Motor

5-Phase Motors PKP

Features Product Line

Product Number Product Line

Standard Type

High-Resolution Type

TS Geared Type

Common Specifications

Motor Pin Arrangement

Drivers for 2-Phase/5-Phase Motors

Peripheral Equipment

High-Resolution Type Frame Size 42 mm (Unipolar 5 lead wires)

Mini-Connector Type

Specifications

Product Name	Maximum Holding Torque [Nm]	Rotor Inertia J: kgm ²	Rated Current A/Phase	Voltage VDC	Winding Resistance Ω/Phase	Inductance mH/Phase	Basic Step Angle
PKP243MU12A2	0.26	39×10 ⁻⁷	1.2	3.2	2.7	3.5	0.9°
PKP243MU12B2	0.35	58×10 ⁻⁷		4.9	4.1	5	
PKP245MU12A2	0.5	78×10 ⁻⁷		3.8	3.2	5.3	
PKP246MU12A2	0.65	116×10 ⁻⁷		4.9	4.1	6.7	

● The box □ in the product name indicates the shaft **A** (single shaft) or **B** (double shaft).

*See "Drivers for 2-Phase / 5-Phase Motors" page for details on the recommended drivers.

Note

● Be sure to set the driver current at or below the motor rated current. If the motor rated current is exceeded, the product will be damaged.

Speed – Torque Characteristics (Reference values) fs: Max. Starting Frequency

PKP243MU12A2/ PKP243MU12B2

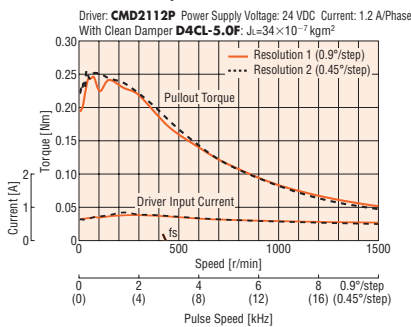

PKP244MU12A2/ PKP244MU12B2

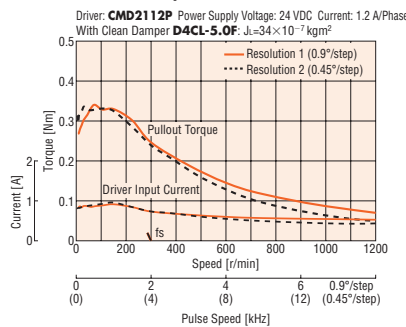

PKP245MU12A2/ PKP245MU12B2

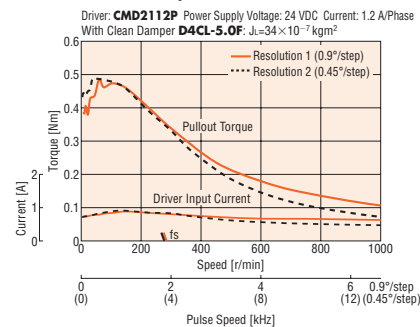

PKP246MU12A2/ PKP246MU12B2

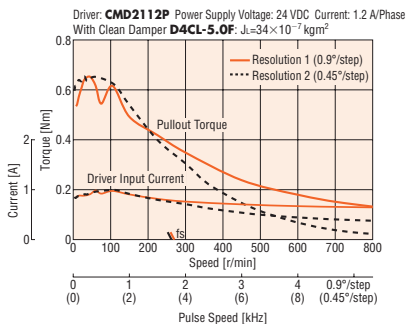

Note

- Data for the speed – torque characteristics is based on Oriental Motor's internal measurement conditions. If the conditions are changed, the characteristics may also change as a result.
- If there is a "clean damper" entry in the speed – torque characteristics, the data is for a double shaft motor when a clean damper is equipped.
- Depending on the driving conditions, a considerable amount of heat may be generated by the motor. Be sure to keep the motor case temperature at 100°C or less.

Dimensions (Unit: mm)

● Motors

Product Name	L1	L2	Mass [kg]
PKP243MU12A2	33	—	0.23
PKP243MU12B2		48	
PKP244MU12A2	39	—	0.3
PKP244MU12B2		54	
PKP245MU12A2	47	—	0.37
PKP245MU12B2		62	
PKP246MU12A2	59	—	0.5
PKP246MU12B2		74	

● Applicable Connectors

Connector Housing: MDF97A-5S-3.5C (HIROSE ELECTRIC CO., LTD.)

Contact: MDF97-22SC (HIROSE ELECTRIC CO., LTD.)

Crimp Tool: HT801/MDF97-22S (HIROSE ELECTRIC CO., LTD.)

● Connection Cables (Sold separately)

◇ Motor Connection Cable

Product Name	Length L [m]
LC2U06E	0.6
LC2U10E	1

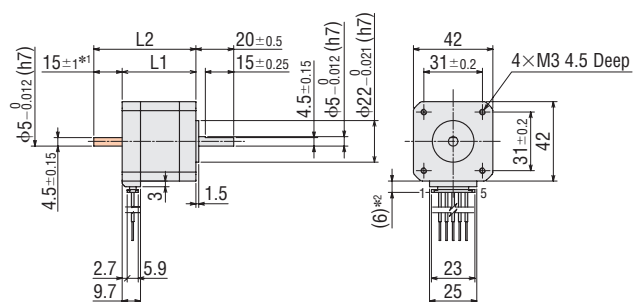
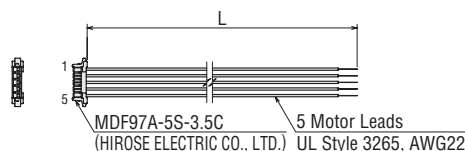

*1 The length of the shaft flat on the double shaft model is 15±0.25.

*2 With connection cable

● These dimensions are for double shaft motors.

For single shaft motors, ignore the shaded areas.

Inner Wiring Diagram of Motor

Wiring Diagram No.: Model A②

● See "Inner Wiring Diagram of Motor" page for the inner wiring diagram of the motor.

High-Resolution Type Frame Size 42 mm (Unipolar 6 lead wires)

Connector Type

Specifications

Product Name	Maximum Holding Torque [Nm]	Rotor Inertia J: kgm ²	Rated Current A/Phase	Voltage VDC	Winding Resistance Ω/Phase	Inductance mH/Phase	Basic Step Angle
PKP243MU09□	0.25	36×10^{-7}	0.95	4.47	4.7	6.6	0.9°
PKP244MU12□	0.35	57×10^{-7}	1.2	4.8	4	6	

● The box □ in the product name indicates the shaft **A** (single shaft) or **B** (double shaft).

*See "Drivers for 2-Phase / 5-Phase Motors" page for details on the recommended drivers.

Note

● Be sure to set the driver current at or below the motor rated current. If the motor rated current is exceeded, the product will be damaged.

Speed – Torque Characteristics (Reference values) *f_s*: Max. Starting Frequency

PKP243MU09A/PKP243MU09B

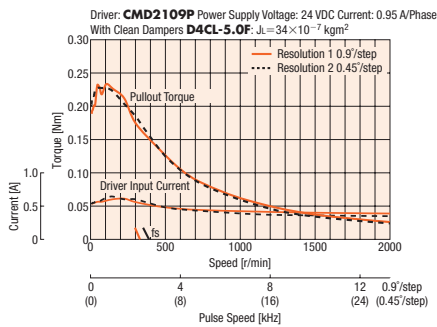

PKP244MU12A/PKP244MU12B

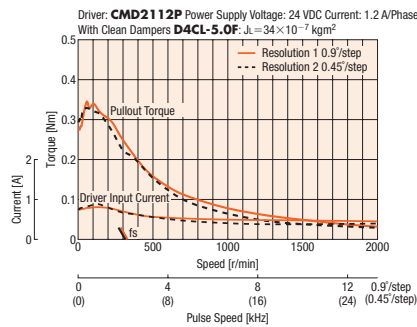

Note

● Data for the speed – torque characteristics is based on Oriental Motor's internal measurement conditions. If the conditions are changed, the characteristics may also change as a result.

● If there is a "clean damper" entry in the speed – torque characteristics, the data is for a double shaft motor when a clean damper is equipped.

● Depending on the driving conditions, a considerable amount of heat may be generated by the motor. Be sure to keep the motor case temperature at 100°C or less.

Dimensions (Unit: mm)

● Motors

Product Name	L1	L2	Mass [kg]
PKP243MU09A	33	—	0.25
PKP243MU09B		48	
PKP244MU12A	39	—	0.3
PKP244MU12B		54	

● Applicable Connectors

Connector Housing: 51103-0600 (Molex)

Contact: 50351-8100 (Molex)

Crimp Tool: 57295-5000 (Molex)

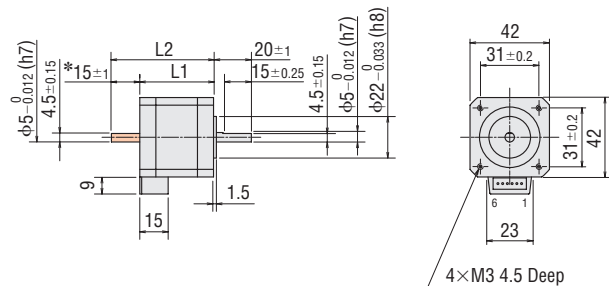

*The length of the shaft flat on the double shaft model is 15 ± 0.25 .

● These dimensions are for double shaft motors.

For single shaft motors, ignore the shaded areas.

● Connection Cable (Sold separately)

◇ Motor Connection Cable

Product Name	Length L [m]
LC2U06B	0.6
LC2U10B	1

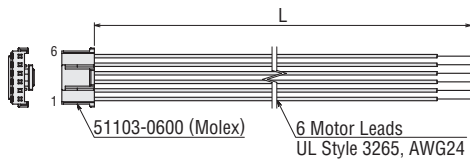

Inner Wiring Diagram of Motor

Wiring Diagram No.: Model B④

● Refer to the motor inner wiring page for an inner wiring diagram of the motor.

2-Phase Motors
PKP

Features Product Line

Product Number Product Line

Standard Type

High-Resolution Type

Flat Type

SH Geared Type

CS Geared Type

Common Specifications

Inner Wiring of Motor

5-Phase Motors
PKP

Features Product Line

Product Number Product Line

Standard Type

High-Resolution Type

TS Geared Type

Common Specifications

Motor Pin Arrangement

Drivers for 2-Phase/5-Phase Motors

Peripheral Equipment

High-Resolution Type with Electromagnetic Brake Frame Size 42 mm (Bipolar 4 lead wires)

Connector Type

13 mm

20 mm

28 mm

35 mm

42 mm

50 mm

51 mm

56.4 mm

60 mm

61 mm

85 mm

90 mm

Specifications

Product Name	Maximum Holding Torque [Nm]	Rotor Inertia J: kgm ²	Rated Current A/Phase	Voltage VDC	Winding Resistance Ω/Phase	Inductance mH/Phase	Basic Step Angle	Electromagnetic Brake Static Friction Torque [Nm]
PKP243MD15M	0.30	48×10 ⁻⁷ *	1.5	2.85	1.9	6.6	0.9°	0.3
PKP244MD15M	0.42	69×10 ⁻⁷ *		3.9	2.6	7.6		

● Refer to the common specification page for electromagnetic brake specifications.

* This value is including the electromagnetic brake inertia.

Note

● Be sure to set the driver current at or below the motor rated current. If the motor rated current is exceeded, the product will be damaged.

Speed – Torque Characteristics (Reference values) fs: Max. Starting Frequency

PKP243MD15M

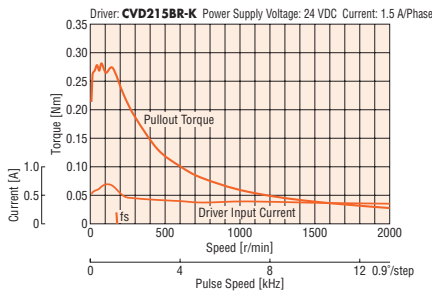

PKP244MD15M

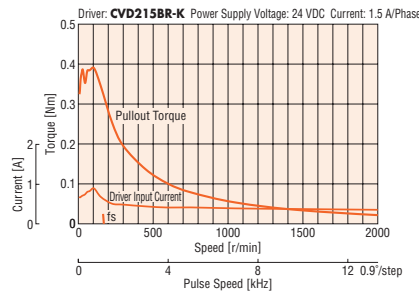

Note

● Data for the speed – torque characteristics is based on Oriental Motor's internal measurement conditions. If the conditions are changed, the characteristics may also change as a result.

● Depending on the driving conditions, a considerable amount of heat may be generated by the motor. Be sure to keep the motor case temperature at 100°C or less.

● The characteristics are the same when RS-485 communication type driver is used in combination.

Dimensions (Unit: mm)

Motors

Product Name	L	Mass [kg]
PKP243MD15M	67	0.36
PKP244MD15M	73	0.41

● Applicable Connector (Molex)

Connector Housing: 51103-0600

Contact: 50351-8100

Crimp Tool: 57295-5000

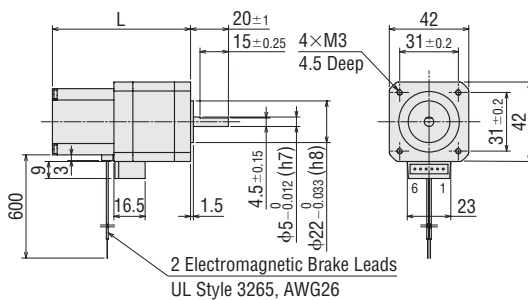

Connection Cables (Sold separately)

◇ Motor Connection Cable

Product Name	Length L [m]
LC2B06B	0.6
LC2B10B	1

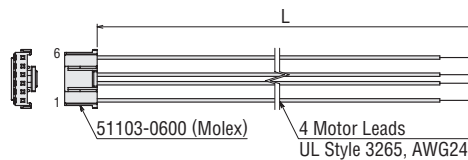

Inner Wiring Diagram of Motor

Wiring Diagram No.: Model B③

● See "Inner Wiring Diagram of Motor" page for the inner wiring diagram of the motor.

High-Resolution Type with Electromagnetic Brake Frame Size 42 mm (Unipolar 6 lead wires) Connector Type

2-Phase
Motors
PKP

Features
Product
Line

Product
Number
Product Line

Standard
Type

High-
Resolution
Type

Flat
Type

SH Geared
Type

CS Geared
Type

Common
Specifications

Inner
Wiring
of Motor

5-Phase
Motors
PKP

Features
Product
Line

Product
Number
Product Line

Standard
Type

High-
Resolution
Type

TS Geared
Type

Common
Specifications

Motor
Pin
Arrangement

Drivers for
2-Phase/5-Phase
Motors

Peripheral
Equipment

Specifications

Product Name	Maximum Holding Torque [Nm]	Rotor Inertia J: kgm ²	Rated Current A/Phase	Voltage VDC	Winding Resistance Ω/Phase	Inductance mH/Phase	Basic Step Angle	Electromagnetic Brake Static Friction Torque [Nm]
PKP243MU09M	0.25	48×10 ⁻⁷ *	0.95	4.47	4.7	6.6	0.9°	0.3
PKP244MU12M	0.35	69×10 ⁻⁷ *	1.2	4.8	4	6		

● Refer to the common specification page for electromagnetic brake specifications.

*The Inertia of the electromagnetic brake is included in the value.

Note

● Be sure to set the driver current at or below the motor rated current. If the motor rated current is exceeded, the product will be damaged.

Speed – Torque Characteristics (Reference values) fs: Max. Starting Frequency

PKP243MU09M

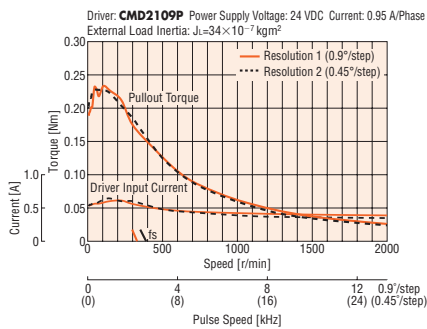

PKP244MU12M

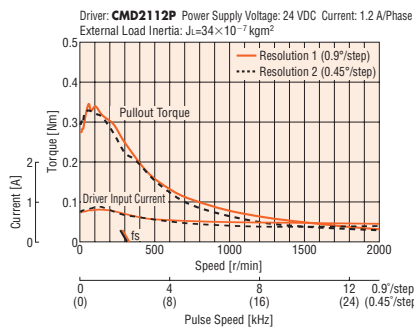

Note

● Data for the speed – torque characteristics is based on Oriental Motor's internal measurement conditions. If the conditions are changed, the characteristics may also change as a result.

● The data in the speed – torque characteristics represents the use of an external load inertia.

● Depending on the driving conditions, a considerable amount of heat may be generated by the motor. Be sure to keep the motor case temperature at 100°C or less.

Dimensions (Unit: mm)

Motors

Product Name	L	Mass [kg]
PKP243MU09M	67	0.36
PKP244MU12M	73	0.41

● Applicable Connector (Molex)

Connector Housing: 51103-0600

Contact: 50351-8100

Crimp Tool: 57295-5000

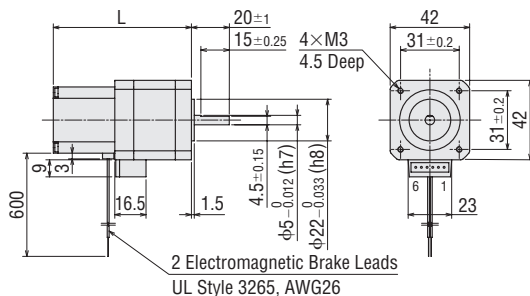

Connection Cable (Sold separately)

◇ Motor Connection Cable

Product Name	Length L [m]
LC2U06B	0.6
LC2U10B	1

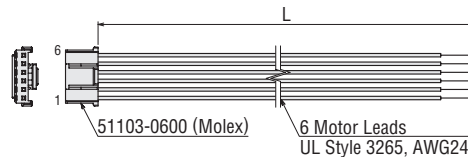

Inner Wiring Diagram of Motor

iring Diagram No.: Model B④

● Refer to the motor inner wiring page for an inner wiring diagram of the motor.

High-Resolution Type Frame Size 56.4 mm (Bipolar 4 lead wires) Mini-Connector Type

□13 mm

□20 mm

□28 mm

□35 mm

□42 mm

□50 mm

□51 mm

□56.4 mm

□60 mm

□61 mm

□85 mm

□90 mm

Specifications

Product Name	Maximum Holding Torque [Nm]	Rotor Inertia J: kgm ²	Rated Current A/Phase	Voltage VDC	Winding Resistance Ω/Phase	Inductance mH/Phase	Basic Step Angle	Recommended Driver Product Name*
PKP264MD28□2	0.7	150×10 ⁻⁷	2.8	2	0.73	2.1	0.9°	CVD228BR-K
PKP266MD28□2	1.4	310×10 ⁻⁷		1.8	0.65	3		
PKP268MD28□2	2.3	520×10 ⁻⁷		2.7	0.97	4.7		

● The box □ in the product name indicates the shaft **A** (single shaft) or **B** (double shaft).

*See "Drivers for 2-Phase / 5-Phase Motors" page for drivers that can be used in combination.

Note

● Be sure to set the driver current at or below the motor rated current. If the motor rated current is exceeded, the product will be damaged.

Speed – Torque Characteristics (Reference values) fs: Max. Starting Frequency

PKP264MD28A2/ PKP264MD28B2

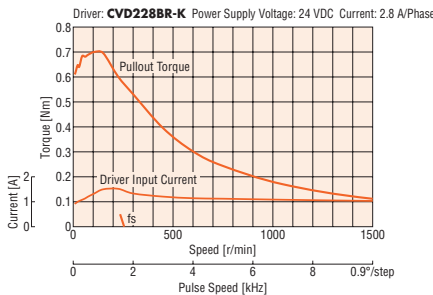

PKP266MD28A2/ PKP266MD28B2

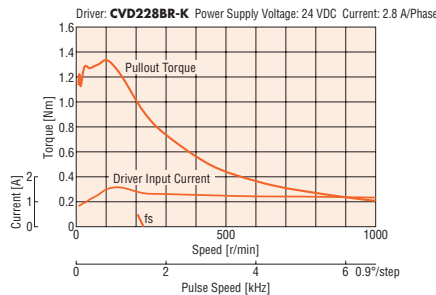

PKP268MD28A2/ PKP268MD28B2

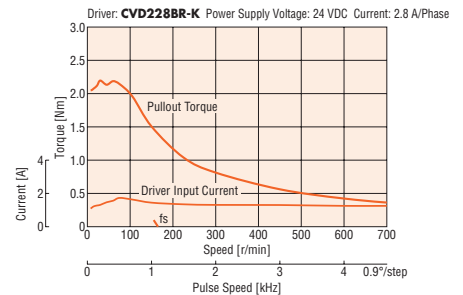

Note

● Data for the speed – torque characteristics is based on Oriental Motor's internal measurement conditions. If the conditions are changed, the characteristics may also change as a result.

● Depending on the driving conditions, a considerable amount of heat may be generated by the motor. Be sure to keep the motor case temperature at 100°C or less.

● The characteristics are the same when RS-485 communication type driver is used in combination.

Dimensions (Unit: mm)

● Motors

Product Name	L1	L2	Mass [kg]
PKP264MD28A2	39	—	0.45
PKP264MD28B2		62	
PKP266MD28A2	54	—	0.7
PKP266MD28B2		77	
PKP268MD28A2	76	—	1.1
PKP268MD28B2		99	

● Applicable Connectors

Connector Housing: MDF97A-5S-3.5C (HIROSE ELECTRIC CO., LTD.)

Contact: MDF97-22SC (HIROSE ELECTRIC CO., LTD.)

Crimp Tool: HT801/MDF97-22S (HIROSE ELECTRIC CO., LTD.)

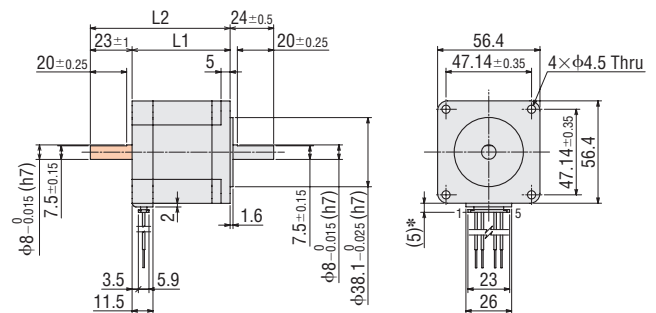

*With connection cable

● These dimensions are for double shaft motors.

For single shaft motors, ignore the shaded areas.

● Connection Cables (Sold separately)

◇ Motor Connection Cable

Product Name	Length L [m]
LC2B06E	0.6
LC2B10E	1

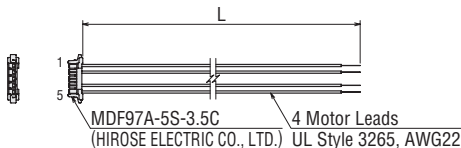

Inner Wiring Diagram of Motor

Wiring Diagram No.: Model A①

● See "Inner Wiring Diagram of Motor" page for the inner wiring diagram of the motor.

High-Resolution Type Frame Size 56.4 mm (Bipolar 4 lead wires)

Connector Type

Specifications

Product Name	Maximum Holding Torque [Nm]	Rotor Inertia J: kgm ²	Rated Current A/Phase	Voltage VDC	Winding Resistance Ω/Phase	Inductance mH/Phase	Basic Step Angle	Recommended Driver Product Name*
PKP264MD28□	0.6	120×10 ⁻⁷	2.8	2	0.73	2.1	0.9°	CVD228BR-K
PKP266MD28□	1.32	290×10 ⁻⁷		2.8	1	3.9		
PKP268MD28□	2.23	490×10 ⁻⁷		3.4	1.23	5.6		

● The box □ in the product name indicates the shaft **A** (single shaft) or **B** (double shaft).

*See "Drivers for 2-Phase / 5-Phase Motors" page for drivers that can be used in combination.

Note

● Be sure to set the driver current at or below the motor rated current. If the motor rated current is exceeded, the product will be damaged.

Speed – Torque Characteristics (Reference values) fs: Max. Starting Frequency

PKP264MD28A/PKP264MD28B

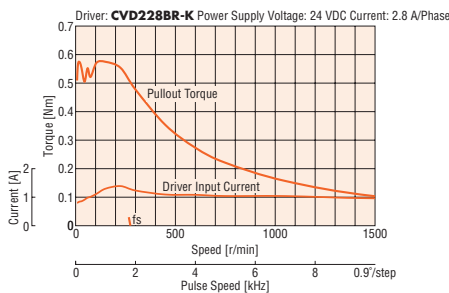

PKP266MD28A/PKP266MD28B

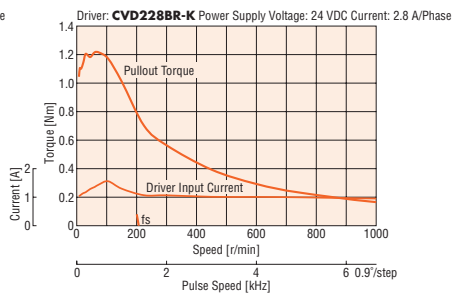

PKP268MD28A/PKP268MD28B

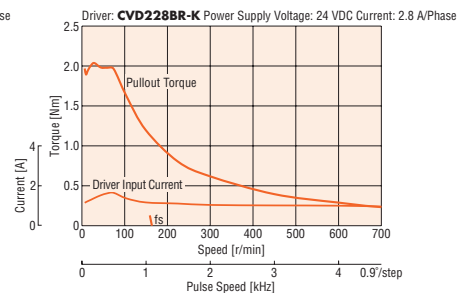

Note

● Data for the speed – torque characteristics is based on Oriental Motor's internal measurement conditions. If the conditions are changed, the characteristics may also change as a result.

● Depending on the driving conditions, a considerable amount of heat may be generated by the motor. Be sure to keep the motor case temperature at 100°C or less.

● The characteristics are the same if combined with an RS-485 communication type driver.

Dimensions (Unit: mm)

● Motors

Product Name	L1	L2	Mass [kg]
PKP264MD28A	39	—	0.46
PKP264MD28B		62	
PKP266MD28A	54	—	0.73
PKP266MD28B		77	
PKP268MD28A	76	—	1.1
PKP268MD28B		99	

● Applicable Connectors

Connector Housing: 51067-0600 (Molex)

Contact: 50217-9101 (Molex)

Crimp Tool: 57189-5000 (Molex)

57190-5000 (Molex)

● Connection Cable (Sold separately)

◇ Motor Connection Cable

Product Name	Length L [m]
LC2B06C	0.6
LC2B10C	1

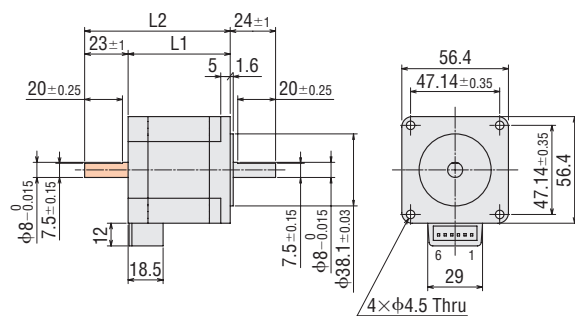
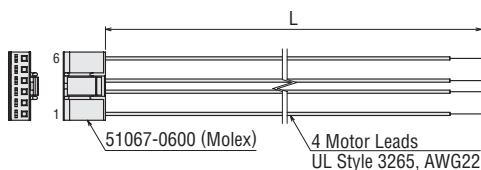

● These dimensions are for double shaft motors.

For single shaft motors, ignore the shaded areas.

Inner Wiring Diagram of Motor

Wiring Diagram No.: Model B③

● Refer to the motor inner wiring page for an inner wiring diagram of the motor.

2-Phase Motors PKP

Features Product Line

Product Number Product Line

Standard Type

High-Resolution Type

Flat Type

SH Geared Type

CS Geared Type

Common Specifications

Inner Wiring of Motor

5-Phase Motors PKP

Features Product Line

Product Number Product Line

Standard Type

High-Resolution Type

TS Geared Type

Common Specifications

Motor Pin Arrangement

Drivers for 2-Phase/5-Phase Motors

Peripheral Equipment

High-Resolution Type Frame Size 56.4 mm (Unipolar 5 lead wires)

Mini-Connector Type

Specifications

Product Name	Maximum Holding Torque [Nm]	Rotor Inertia J: kgm ²	Rated Current A/Phase	Voltage VDC	Winding Resistance Ω/Phase	Inductance mH/Phase	Basic Step Angle
PKP264MU20□2	0.55	150×10 ⁻⁷	2	2.9	1.45	2.1	0.9°
PKP266MU20□2	1.2	310×10 ⁻⁷		2.8	1.39	3.5	
PKP268MU20□2	1.8	520×10 ⁻⁷		3.6	1.81	4.3	

● The box □ in the product name indicates the shaft **A** (single shaft) or **B** (double shaft).

*See "Drivers for 2-Phase / 5-Phase Motors" page for details on the recommended drivers.

Note

● Be sure to set the driver current at or below the motor rated current. If the motor rated current is exceeded, the product will be damaged.

Speed – Torque Characteristics (Reference values) fs: Max. Starting Frequency

PKP264MU20A2/ PKP264MU20B2

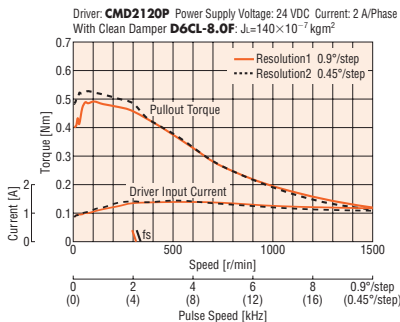

PKP266MU20A2/ PKP266MU20B2

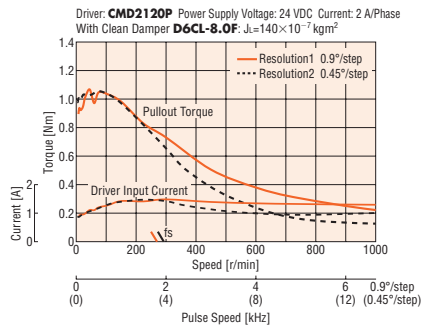

PKP268MU20A2/ PKP268MU20B2

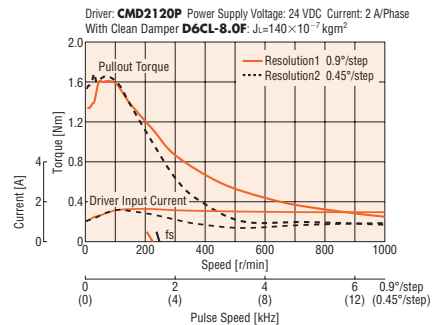

Note

- Data for the speed – torque characteristics is based on Oriental Motor's internal measurement conditions. If the conditions are changed, the characteristics may also change as a result.
- If there is a "clean damper" entry in the speed – torque characteristics, the data is for a double shaft motor when a clean damper is equipped.
- Depending on the driving conditions, a considerable amount of heat may be generated by the motor. Be sure to keep the motor case temperature at 100°C or less.

Dimensions (Unit: mm)

● Motors

Product Name	L1	L2	Mass [kg]
PKP264MU20A2	39	—	0.45
PKP264MU20B2		62	
PKP266MU20A2	54	—	0.7
PKP266MU20B2		77	
PKP268MU20A2	76	—	1.1
PKP268MU20B2		99	

● Applicable Connectors

Connector Housing: MDF97A-5S-3.5C (HIROSE ELECTRIC CO., LTD.)

Contact: MDF97-22SC (HIROSE ELECTRIC CO., LTD.)

Crimp Tool: HT801/MDF97-22S (HIROSE ELECTRIC CO., LTD.)

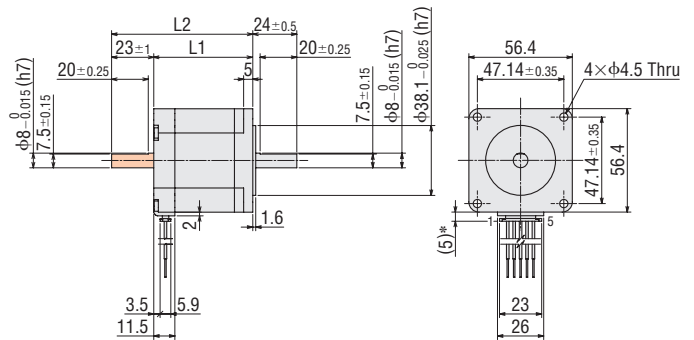

*With connection cable

● These dimensions are for double shaft motors.

For single shaft motors, ignore the shaded areas.

● Connection Cables (Sold separately)

◇ Motor Connection Cable

Product Name	Length L [m]
LC2U06E	0.6
LC2U10E	1

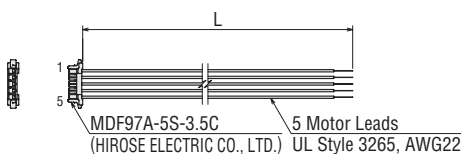

Inner Wiring Diagram of Motor

Wiring Diagram No.: Model A②

● See "Inner Wiring Diagram of Motor" page for the inner wiring diagram of the motor.

High-Resolution Type Frame Size 56.4 mm (Unipolar 6 lead wires) Connector Type

Specifications

Product Name	Maximum Holding Torque [Nm]	Rotor Inertia J: kgm ²	Rated Current A/Phase	Voltage VDC	Winding Resistance Ω/Phase	Inductance mH/Phase	Basic Step Angle
PKP264MU20□	0.51	120×10 ⁻⁷	2	2.9	1.45	2.1	0.9°
PKP266MU20□	1.1	290×10 ⁻⁷		4	2	3.9	
PKP268MU20□	1.75	490×10 ⁻⁷		4.9	2.45	5.6	

● The box □ in the product name indicates the shaft **A** (single shaft) or **B** (double shaft).
*See "Drivers for 2-Phase / 5-Phase Motors" page for details on the recommended drivers.

Note

● Be sure to set the driver current at or below the motor rated current. If the motor rated current is exceeded, the product will be damaged.

Speed – Torque Characteristics (Reference values) *f*_s: Max. Starting Frequency

PKP264MU20A/PKP264MU20B

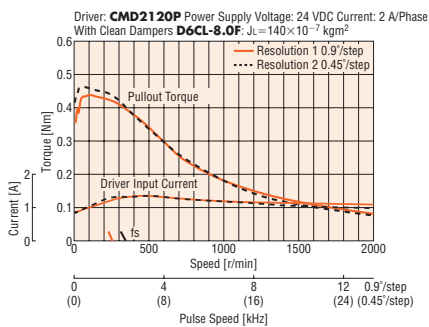

PKP266MU20A/PKP266MU20B

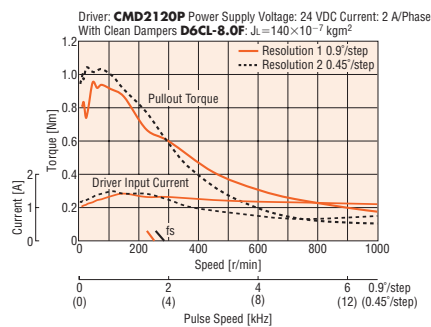

PKP268MU20A/PKP268MU20B

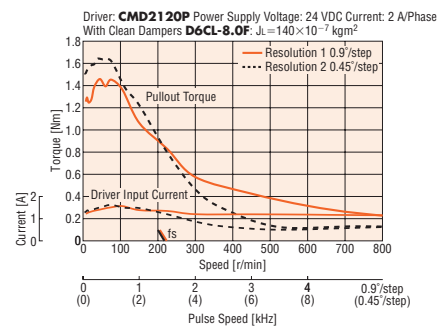

Note

● Data for the speed – torque characteristics is based on Oriental Motor's internal measurement conditions. If the conditions are changed, the characteristics may also change as a result.
● If there is a "clean damper" entry in the speed – torque characteristics, the data is for a double shaft motor when a clean damper is equipped.
● Depending on the driving conditions, a considerable amount of heat may be generated by the motor. Be sure to keep the motor case temperature at 100°C or less.

Dimensions (Unit: mm)

Motors

Product Name	L1	L2	Mass [kg]
PKP264MU20A	39	—	0.46
PKP264MU20B		62	
PKP266MU20A	54	—	0.73
PKP266MU20B		77	
PKP268MU20A	76	—	1.1
PKP268MU20B		99	

Applicable Connectors

Connector Housing: 51067-0600 (Molex)
Contact: 50217-9101 (Molex)
Crimp Tool: 57189-5000 (Molex)
57190-5000 (Molex)

Connection Cable (Sold separately)

Motor Connection Cable

Product Name	Length L [m]
LC2U06C	0.6
LC2U10C	1

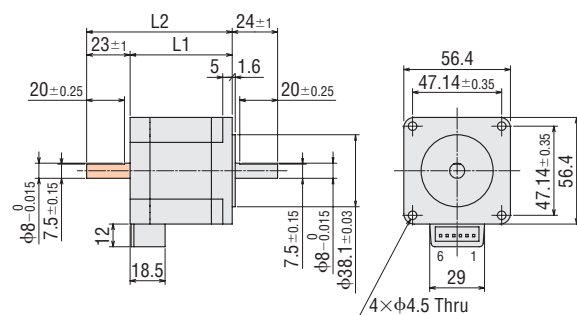
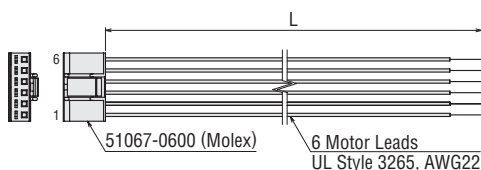

● These dimensions are for double shaft motors.
For single shaft motors, ignore the shaded areas.

Inner Wiring Diagram of Motor

Wiring Diagram No.: Model B④

● Refer to the motor inner wiring page for an inner wiring diagram of the motor.

2-Phase
Motors
PKP

Features
Product
Line

Product
Number
Product Line

Standard
Type

High-
Resolution
Type

Flat
Type

SH Geared
Type

CS Geared
Type

Common
Specifications

Inner
Wiring
of Motor

5-Phase
Motors
PKP

Features
Product
Line

Product
Number
Product Line

Standard
Type

High-
Resolution
Type

TS Geared
Type

Common
Specifications

Motor
Pin
Arrangement

Drivers for
2-Phase/5-Phase
Motors

Peripheral
Equipment

High-Resolution Type with Electromagnetic Brake Frame Size 56.4 mm (Bipolar 4 lead wires)

Connector Type

13 mm

20 mm

28 mm

35 mm

42 mm

50 mm

51 mm

56.4 mm

60 mm

61 mm

85 mm

90 mm

Specifications

Product Name	Maximum Holding Torque [Nm]	Rotor Inertia J: kgm ²	Rated Current A/Phase	Voltage VDC	Winding Resistance Ω/Phase	Inductance mH/Phase	Basic Step Angle	Electromagnetic Brake Static Friction Torque [Nm]
PKP264MD28M	0.6	270×10 ⁻⁷ *	2.8	2	0.73	2.1	0.9°	1.5
PKP266MD28M	1.32	440×10 ⁻⁷ *		2.8	1	3.9		
PKP268MD28M	2.23	640×10 ⁻⁷ *		3.4	1.23	5.6		

● Refer to the common specification page for electromagnetic brake specifications.

* This value is including the electromagnetic brake inertia.

Note

● Be sure to set the driver current at or below the motor rated current. If the motor rated current is exceeded, the product will be damaged.

Speed – Torque Characteristics (Reference values) fs: Max. Starting Frequency

PKP264MD28M

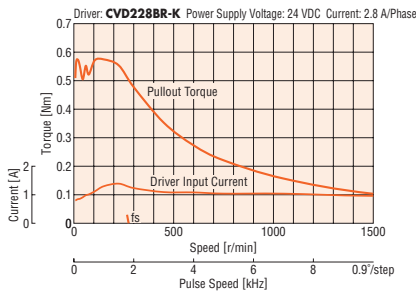

PKP266MD28M

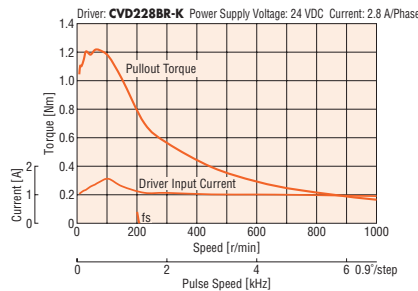

PKP268MD28M

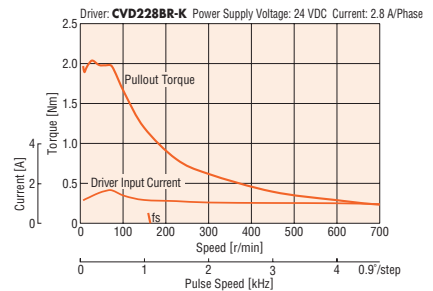

Note

● Data for the speed – torque characteristics is based on Oriental Motor's internal measurement conditions. If the conditions are changed, the characteristics may also change as a result.

● Depending on the driving conditions, a considerable amount of heat may be generated by the motor. Be sure to keep the motor case temperature at 100°C or less.

● The characteristics are the same when RS-485 communication type driver is used in combination.

Dimensions (Unit: mm)

● Motors

Product Name	L	Mass [kg]
PKP264MD28M	75.5	0.76
PKP266MD28M	90.5	1.03
PKP268MD28M	112.5	1.4

● Applicable Connector (Molex)

Connector Housing: 51067-0600

Contact: 50217-9101

Crimp Tool: 57189-5000

57190-5000

● Connection Cable (Sold separately)

◇ Motor Connection Cable

Product Name	Length L [m]
LC2B06C	0.6
LC2B10C	1

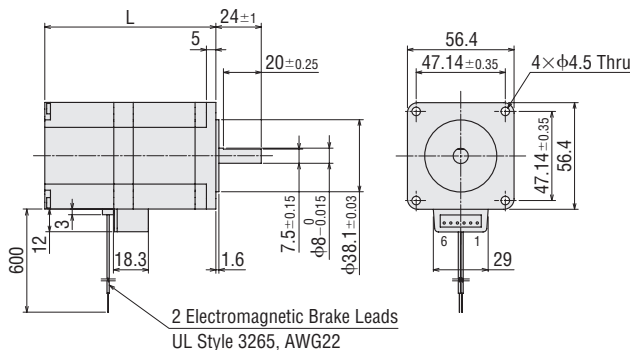
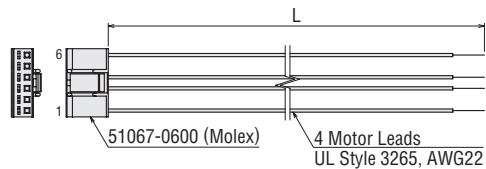

Inner Wiring Diagram of Motor

Wiring Diagram No.: Model B③

● See "Inner Wiring Diagram of Motor" page for the inner wiring diagram of the motor.

High-Resolution Type with Electromagnetic Brake Frame Size 56.4 mm (Unipolar 6 lead wires) Connector Type

2-Phase
Motors
PKP

Features
Product
Line

Product
Number
Product Line

Standard
Type

High-
Resolution
Type

Flat
Type

SH Geared
Type

CS Geared
Type

Common
Specifications

Inner
Wiring
of Motor

5-Phase
Motors
PKP

Features
Product
Line

Product
Number
Product Line

Standard
Type

High-
Resolution
Type

TS Geared
Type

Common
Specifications

Motor
Pin
Arrangement

Drivers for
2-Phase/5-Phase
Motors

Peripheral
Equipment

Specifications

Product Name	Maximum Holding Torque [Nm]	Rotor Inertia J: kgm ²	Rated Current A/Phase	Voltage VDC	Winding Resistance Ω/Phase	Inductance mH/Phase	Basic Step Angle	Electromagnetic Brake Static Friction Torque [Nm]
PKP264MU20M	0.51	270×10 ⁻⁷ *	2	2.9	1.45	2.1	0.9°	1.5
PKP266MU20M	1.1	440×10 ⁻⁷ *		4	2	3.9		
PKP268MU20M	1.75	640×10 ⁻⁷ *		4.9	2.45	5.6		

● Refer to the common specification page for electromagnetic brake specifications.

* This value is including the electromagnetic brake inertia.

Note

● Be sure to set the driver current at or below the motor rated current. If the motor rated current is exceeded, the product will be damaged.

Speed – Torque Characteristics (Reference values) fs: Max. Starting Frequency

PKP264MU20M

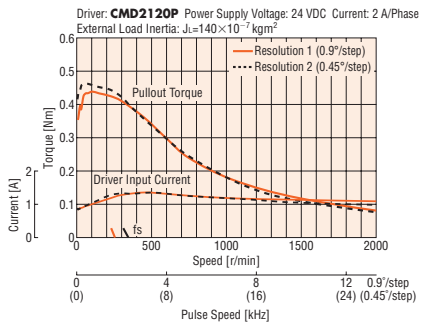

PKP266MU20M

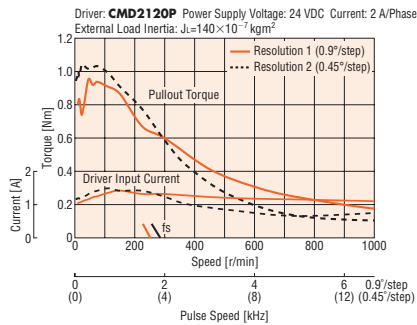

PKP268MU20M

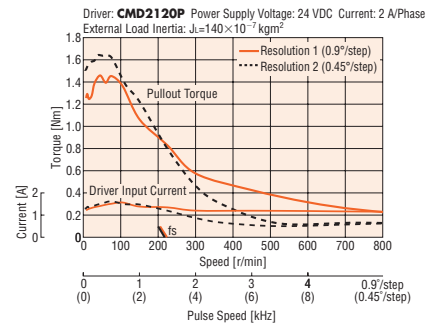

Note

● Data for the speed – torque characteristics is based on Oriental Motor's internal measurement conditions. If the conditions are changed, the characteristics may also change as a result.

● The data in the speed – torque characteristics represents the use of an external load inertia.

● Depending on the driving conditions, a considerable amount of heat may be generated by the motor. Be sure to keep the motor case temperature at 100°C or less.

Dimensions (Unit: mm)

● Motors

Product Name	L	Mass [kg]
PKP264MU20M	75.5	0.76
PKP266MU20M	90.5	1.03
PKP268MU20M	112.5	1.4

● Applicable Connector (Molex)

Connector Housing: 51067-0600
Contact: 50217-9101
Crimp Tool: 57189-5000
57190-5000

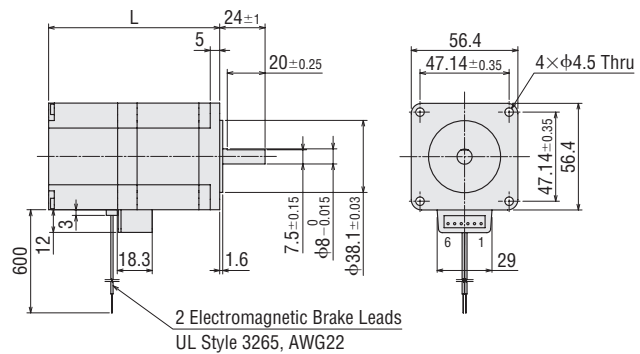

2 Electromagnetic Brake Leads
UL Style 3265, AWG22

● Connection Cable (Sold separately)

◇ Motor Connection Cable

Product Name	Length L [m]
LC2U06C	0.6
LC2U10C	1

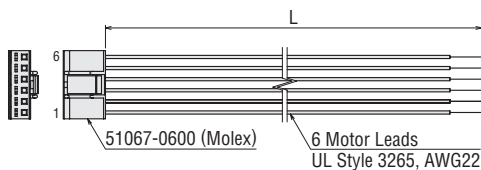

Inner Wiring Diagram of Motor

Wiring Diagram No.: Model B④

● See "Inner Wiring Diagram of Motor" page for the inner wiring diagram of the motor.

Flat Type Frame Size 42 mm (Bipolar 4 lead wires)

Mini-Connector Type

13 mm

20 mm

28 mm

35 mm

42 mm

50 mm

51 mm

56.4 mm

60 mm

61 mm

85 mm

90 mm

Specifications

Product Name	Maximum Holding Torque [Nm]	Rotor Inertia J: kgm ²	Rated Current A/Phase	Voltage VDC	Winding Resistance Ω/Phase	Inductance mH/Phase	Basic Step Angle	Recommended Driver Product Name*
PKP242D23A2	0.1	13×10 ⁻⁷	2.3	1.4	0.61	0.53	1.8°	CVD223FBR-K

*See "Drivers for 2-Phase / 5-Phase Motors" page for drivers that can be used in combination.

Note

- Be sure to set the driver current at or below the motor rated current. If the motor rated current is exceeded, the product will be damaged.

Speed – Torque Characteristics (Reference values) fs: Max. Starting Frequency

PKP242D23A2

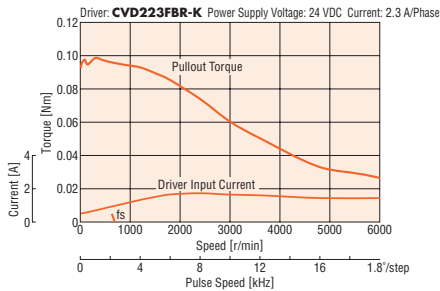

Note

- Data for the speed – torque characteristics is based on Oriental Motor's internal measurement conditions. If the conditions are changed, the characteristics may also change as a result.
- Depending on the driving conditions, a considerable amount of heat may be generated by the motor. Be sure to keep the motor case temperature at 100°C or less.
- The characteristics are the same when RS-485 communication type driver is used in combination.

Dimensions (Unit: mm)

● Motors

Product Name	Mass [kg]
PKP242D23A2	0.11

● Applicable Connectors

- Connector Housing: MDF97A-5S-3.5C (HIROSE ELECTRIC CO., LTD.)
- Contact: MDF97-22SC (HIROSE ELECTRIC CO., LTD.)
- Crimp Tool: HT801/MDF97-22S (HIROSE ELECTRIC CO., LTD.)

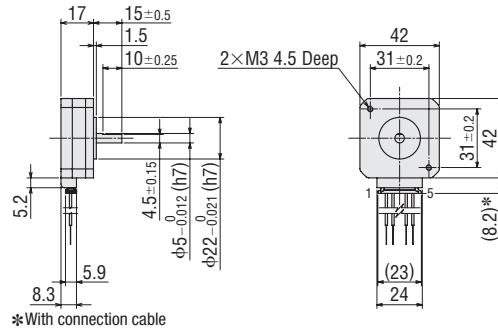

● Connection Cables (Sold separately)

◇ Motor Connection Cable

Product Name	Length L [m]
LC2B06E	0.6
LC2B10E	1

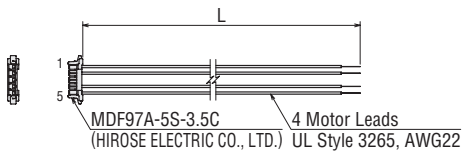

Inner Wiring Diagram of Motor

Wiring Diagram No.: Model A①

- See "Inner Wiring Diagram of Motor" page for the inner wiring diagram of the motor.

Flat Type Frame Size 60 mm (Bipolar 4 lead wires)

Lead Wire Type

Specifications

Product Name	Maximum Holding Torque [Nm]	Rotor Inertia J: kgm ²	Rated Current A/Phase	Voltage VDC	Winding Resistance Ω/Phase	Inductance mH/Phase	Basic Step Angle	Recommended Driver Product Name*
PKP262FD15AW	0.18	68×10^{-7}	1.5	2.25	1.5	1.4	1.8°	CVD215BR-K

*See "Drivers for 2-Phase / 5-Phase Motors" page for drivers that can be used in combination.

Note

- Be sure to set the driver current at or below the motor rated current. If the motor rated current is exceeded, the product will be damaged.

Speed – Torque Characteristics (Reference values) fs: Max. Starting Frequency

PKP262FD15AW

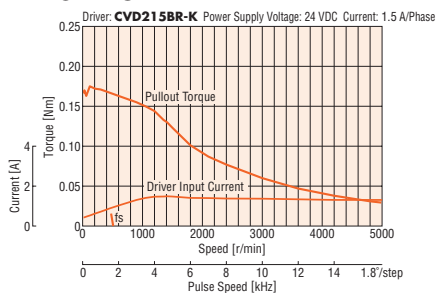

Note

- Data for the speed – torque characteristics is based on Oriental Motor's internal measurement conditions. If the conditions are changed, the characteristics may also change as a result.
- Depending on the driving conditions, a considerable amount of heat may be generated by the motor. Be sure to keep the motor case temperature at 100°C or less.
- The characteristics are the same when RS-485 communication type driver is used in combination.

Dimensions (Unit: mm)

Motors

Product Name	Mass [kg]
PKP262FD15AW	0.2

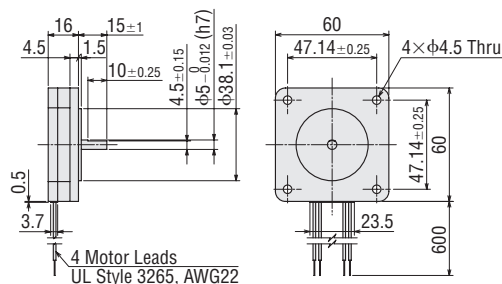

Inner Wiring Diagram of Motor

Wiring Diagram No.: Model C⑤

- See "Inner Wiring Diagram of Motor" page for the inner wiring diagram of the motor.

2-Phase Motors
PKP

Features Product Line

Product Number Product Line

Standard Type

High-Resolution Type

Flat Type

SH Geared Type

CS Geared Type

Common Specifications

Inner Wiring of Motor

5-Phase Motors
PKP

Features Product Line

Product Number Product Line

Standard Type

High-Resolution Type

TS Geared Type

Common Specifications

Motor Pin Arrangement

Drivers for 2-Phase/5-Phase Motors

Peripheral Equipment

Flat Type with Harmonic Gear

Frame Size 51 mm (Bipolar 4 lead wires)

Mini-Connector Type

13 mm

20 mm

28 mm

35 mm

42 mm

50 mm

51 mm

56.4 mm

60 mm

61 mm

85 mm

90 mm

Specifications

Product Name	Maximum Holding Torque [Nm]	Rotor Inertia J: kgm ²	Rated Current A/Phase	Voltage VDC	Winding Resistance Ω/Phase	Inductance mH/Phase	Basic Step Angle	Gear Ratio	Permissible Torque [Nm]	Maximum Instantaneous Torque [Nm]	Lost Motion (Load Torque) arcmin	Speed Range r/min	Recommended Driver Product Name*
PKP242D23A2-H50	1.8	17×10 ⁻⁷	2.3	1.4	0.61	0.53	0.036°	50	1.8	3.3	1.5 max. (±0.09 Nm)	0 – 70	CVD223FBR-K
PKP242D23A2-H100	2.4						0.018°	100	2.4	4.8	1.5 max. (±0.12 Nm)	0 – 35	

*See "Drivers for 2-Phase / 5-Phase Motors" page for drivers that can be used in combination.

Note

- The rotor inertia represents a sum of the inertia of the harmonic gear converted to motor shaft values.
- Be sure to set the driver current at or below the motor rated current. If the motor rated current is exceeded, the product will be damaged.

Speed – Torque Characteristics (Reference values) fs: Max. Starting Frequency

PKP242D23A2-H50

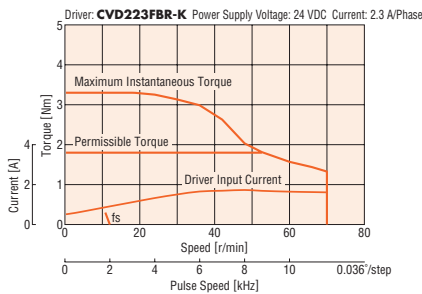

PKP242D23A2-H100

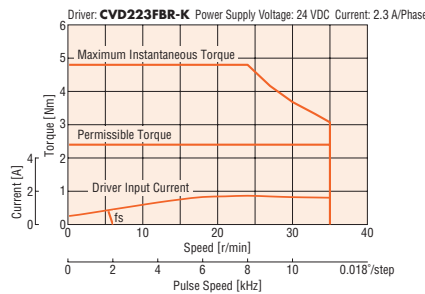

Note

- Data for the speed – torque characteristics is based on Oriental Motor's internal measurement conditions. If the conditions are changed, the characteristics may also change as a result.
- The speed – torque characteristics is data when the gear case temperature is at 25 to 30°C. As the temperature decreases, the viscosity of the grease in the gear increases and the torque decreases.
- In order to prevent deterioration of the gear grease in the harmonic geared type, keep the temperature of the gear case at 70°C max.
- The characteristics are the same when RS-485 communication type driver is used in combination.

Dimensions (Unit: mm)

Motors

Product Name	Mass [kg]
PKP242D23A2-H50	0.32
PKP242D23A2-H100	

Applicable Connectors

- Connector Housing: MDF97A-5S-3.5C (HIROSE ELECTRIC CO., LTD.)
- Contact: MDF97-22SC (HIROSE ELECTRIC CO., LTD.)
- Crimp Tool: HT801/MDF97-22S (HIROSE ELECTRIC CO., LTD.)

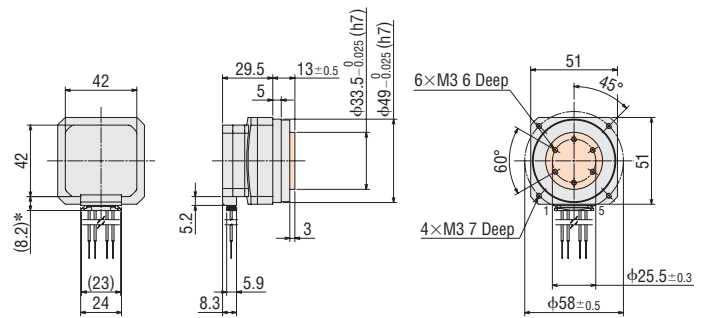

- The shaded areas are rotating parts.
- *With connection cable

Connection Cables (Sold separately)

Motor Connection Cable

Product Name	Length L [m]
LC2B06E	0.6
LC2B10E	1

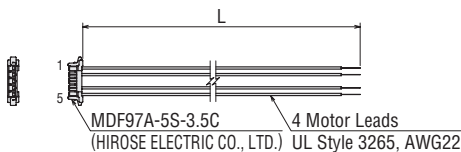

Inner Wiring Diagram of Motor

Wiring Diagram No.: Model A①

- See "Inner Wiring Diagram of Motor" page for the inner wiring diagram of the motor.

Flat Type with Harmonic Gear

Frame Size 61 mm (Bipolar 4 lead wires)

Lead Wire Type

Specifications

Product Name	Maximum Holding Torque [Nm]	Rotor Inertia J: kgm ²	Rated Current A/Phase	Voltage VDC	Winding Resistance Ω/Phase	Inductance mH/Phase	Basic Step Angle	Gear Ratio	Permissible Torque [Nm]	Maximum Instantaneous Torque [Nm]	Lost Motion (Load Torque) arcmin	Speed Range r/min	Recommended Driver Product Name*
PKP262FD15AW-H50S	3.5	83×10 ⁻⁷	1.5	1.65	1.1	0.8	0.036°	50	3.5	*	1.5 max. (±0.17 Nm)	0 to 70	CVD215BR-K
PKP262FD15AW-H100S	5						0.018°	100	5	*	1.5 max. (±0.25 Nm)	0 to 35	

*For the output torque of the geared motor, refer to the speed–torque characteristics.

*See "Drivers for 2-Phase / 5-Phase Motors" page for drivers that can be used in combination.

Note

- The rotor inertia represents a sum of the inertia of the harmonic gear converted to motor shaft values.
- Be sure to set the driver current at or below the motor rated current. If the motor rated current is exceeded, the product will be damaged.

Speed – Torque Characteristics (Reference values) fs: Max. Starting Frequency

PKP262FD15AW-H50S

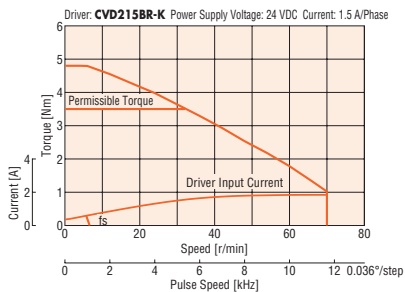

PKP262FD15AW-H100S

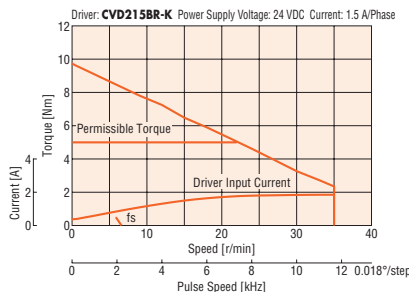

Note

- Data for the speed – torque characteristics is based on Oriental Motor's internal measurement conditions. If the conditions are changed, the characteristics may also change as a result.
- The speed – torque characteristics is data when the gear case temperature is at 25 to 30°C. As the temperature decreases, the viscosity of the grease in the gear increases and the torque decreases.
- In order to prevent deterioration of the gear grease in the harmonic geared type, keep the temperature of the gear case at 70°C max.
- The characteristics are the same when RS-485 communication type driver is used in combination.

Dimensions (Unit: mm)

Motors

Product Name	Mass [kg]
PKP262FD15AW-H50S	0.54
PKP262FD15AW-H100S	

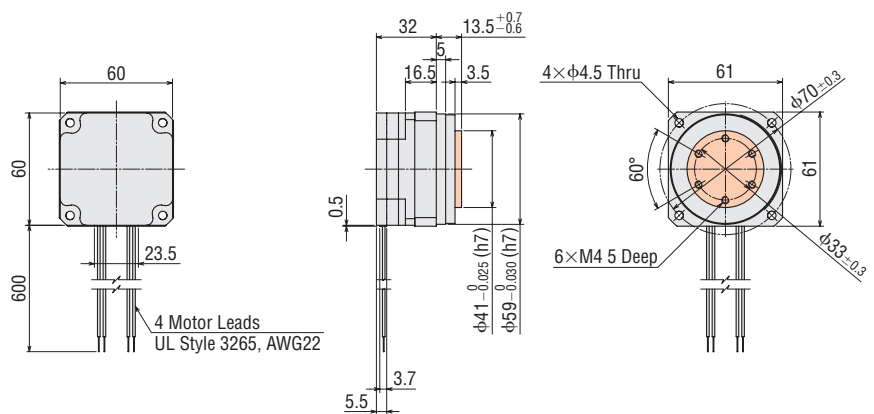

● The shaded areas are rotating parts.

Inner Wiring Diagram of Motor

Wiring Diagram No.: Model C⑤

- See "Inner Wiring Diagram of Motor" page for the inner wiring diagram of the motor.

2-Phase Motors
PKP

Features Product Line

Product Number Product Line

Standard Type

High-Resolution Type

Flat Type

SH Geared Type

CS Geared Type

Common Specifications

Inner Wiring of Motor

5-Phase Motors
PKP

Features Product Line

Product Number Product Line

Standard Type

High-Resolution Type

TS Geared Type

Common Specifications

Motor Pin Arrangement

Drivers for 2-Phase/5-Phase Motors

Peripheral Equipment

SH Geared Type Frame Size 28 mm (Bipolar 4 lead wires)

Connector Type

Specifications

Product Name	Maximum Holding Torque [Nm]	Rotor Inertia J: kgm ²	Rated Current A/Phase	Voltage VDC	Winding Resistance Ω/Phase	Inductance mH/Phase	Basic Step Angle	Gear Ratio	Permissible Torque [Nm]	Speed Range r/min	Backlash arcmin	Recommended Driver Product Name*
PKP223D15□-SG7.2	0.3	9×10 ⁻⁷	1.5	1.8	1.2	0.74	0.25°	7.2	0.3	0 – 416	90 (1.5)	CVD215BR-K
PKP223D15□-SG9							0.2°	9		0 – 333		
PKP223D15□-SG10							0.18°	10		0 – 300		
PKP223D15□-SG18	0.4						0.1°	18	0.4	0 – 166		
PKP223D15□-SG36							0.05°	36		0 – 83		

● The box □ in the product name indicates the shaft **A** (single shaft) or **B** (double shaft).

*See "Drivers for 2-Phase / 5-Phase Motors" page for drivers that can be used in combination.

Note

● Be sure to set the driver current at or below the motor rated current. If the motor rated current is exceeded, the product will be damaged.

Speed – Torque Characteristics (Reference values) fs: Max. Starting Frequency

PKP223D15A-SG7.2/PKP223D15B-SG7.2

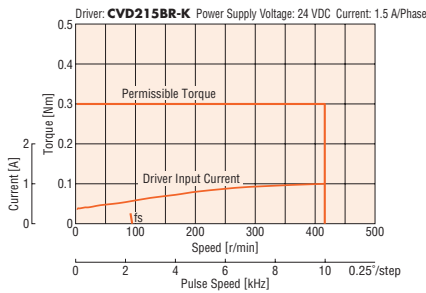

PKP223D15A-SG9/PKP223D15B-SG9

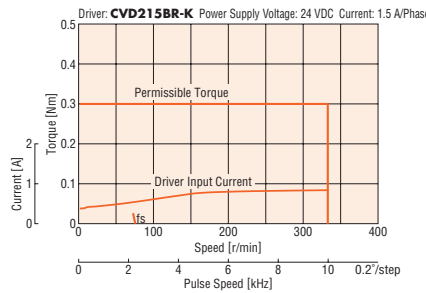

PKP223D15A-SG10/PKP223D15B-SG10

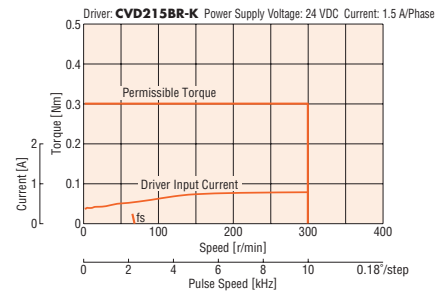

PKP223D15A-SG18/PKP223D15B-SG18

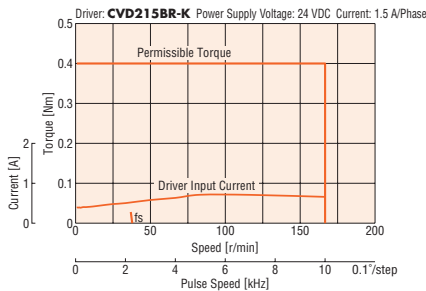

PKP223D15A-SG36/PKP223D15B-SG36

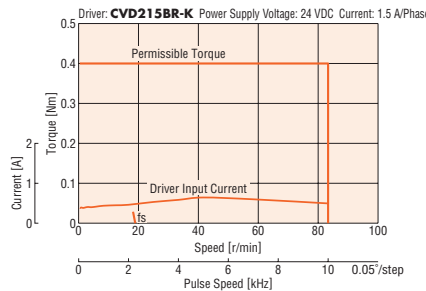

Note

● Data for the speed – torque characteristics is based on Oriental Motor's internal measurement conditions. If the conditions are changed, the characteristics may also change as a result.

● Depending on the driving conditions, a considerable amount of heat may be generated by the motor. Be sure to keep the motor case temperature at 100°C or less.

● The characteristics are the same when RS-485 communication type driver is used in combination.

Dimensions (Unit: mm)

Motors

Product Name	Gear Ratio	Mass [kg]
PKP223D15A-SG□	7.2, 9, 10, 18, 36	0.16
PKP223D15B-SG□		

● The box □ in the product name indicates a number representing the gear ratio.

● Applicable Connectors

Connector Housing: 51065-0600 (Molex)

Contact: 50212-8100 (Molex)

Crimp Tool: 57176-5000 (Molex)

Connection Cables (Sold separately)

Motor Connection Cable

Product Name	Length L [m]
LC2B06A	0.6
LC2B10A	1

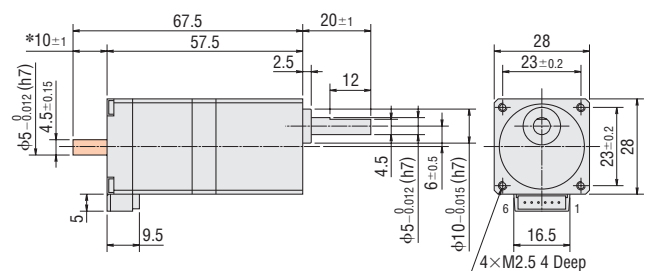
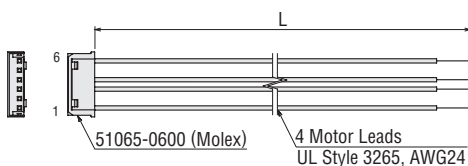

*The length of the shaft flat on the double shaft model is 10±0.25.

● These dimensions are for double shaft motors.

For single shaft motors, ignore the shaded areas.

Inner Wiring Diagram of Motor

Wiring Diagram No.: Model B③

● See "Inner Wiring Diagram of Motor" page for the inner wiring diagram of the motor.

SH Geared Type Frame Size 28 mm (Unipolar 6 lead wires) Connector Type

Specifications

Product Name	Maximum Holding Torque [Nm]	Rotor Inertia J: kgm ²	Rated Current A/Phase	Voltage VDC	Winding Resistance Ω/Phase	Inductance mH/Phase	Basic Step Angle	Gear Ratio	Permissible Torque [Nm]	Speed Range r/min	Backlash arcmin
PKP223U09□-SG7.2	0.3	9×10 ⁻⁷	0.95	2.66	2.8	1	0.25°	7.2	0.3	0 – 416	90 (1.5)
PKP223U09□-SG9							0.2°	9		0 – 333	
PKP223U09□-SG10							0.18°	10		0 – 300	
PKP223U09□-SG18	0.4						0.1°	18	0.4	0 – 166	
PKP223U09□-SG36							0.05°	36		0 – 83	

● The box □ in the product name indicates the shaft **A** (single shaft) or **B** (double shaft).

Note

● Be sure to set the driver current at or below the motor rated current. If the motor rated current is exceeded, the product will be damaged.

Speed – Torque Characteristics (Reference values) fs: Max. Starting Frequency

PKP223U09A-SG7.2/PKP223U09B-SG7.2

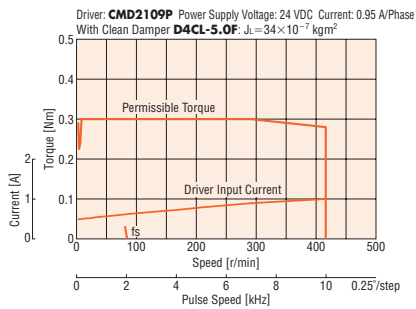

PKP223U09A-SG9/PKP223U09B-SG9

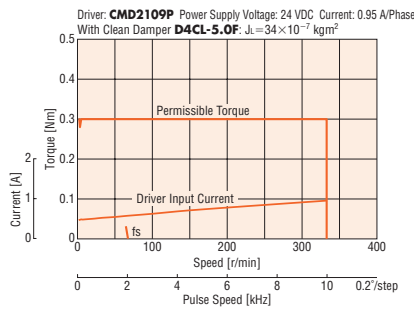

PKP223U09A-SG10/PKP223U09B-SG10

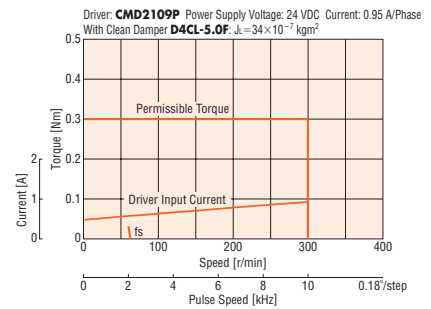

PKP223U09A-SG18/PKP223U09B-SG18

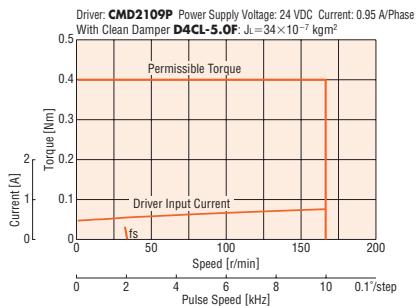

PKP223U09A-SG36/PKP223U09B-SG36

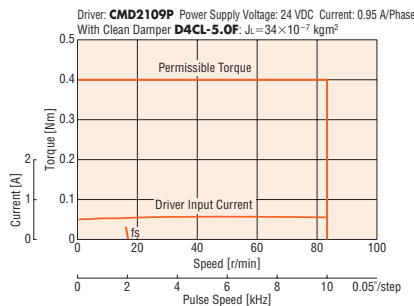

Note

- Data for the speed – torque characteristics is based on Oriental Motor's internal measurement conditions. If the conditions are changed, the characteristics may also change as a result.
- If there is a "clean damper" entry in the speed – torque characteristics, the data is for a double shaft motor when a clean damper is equipped.
- Depending on the driving conditions, a considerable amount of heat may be generated by the motor. Be sure to keep the motor case temperature at 100°C or less.

Dimensions (Unit: mm)

Motors

Product Name	Gear Ratio	Mass [kg]
PKP223U09A-SG□	7.2, 9	0.16
PKP223U09B-SG□	10, 18, 36	

● The box □ in the product name indicates a number representing the gear ratio.

Applicable Connectors

Connector Housing: 51065-0600 (Molex)
Contact: 50212-8100 (Molex)
Crimp Tool: 57176-5000 (Molex)

Connection Cables (Sold separately)

Motor Connection Cable

Product Name	Length L [m]
LC2U06A	0.6
LC2U10A	1

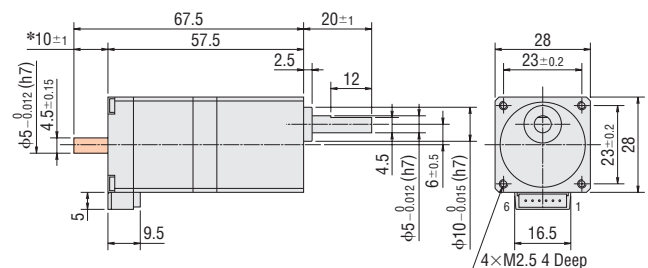
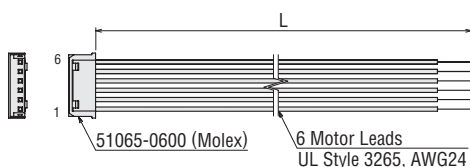

*The length of the shaft flat on the double shaft model is 10±0.25.

● These dimensions are for double shaft motors.

For single shaft motors, ignore the shaded areas.

Inner Wiring Diagram of Motor

Wiring Diagram No.: Model B④

● See "Inner Wiring Diagram of Motor" page for the inner wiring diagram of the motor.

2-Phase Motors PKP

Features Product Line

Product Number Product Line

Standard Type

High-Resolution Type

Flat Type

SH Geared Type

CS Geared Type

Common Specifications

Inner Wiring of Motor

5-Phase Motors PKP

Features Product Line

Product Number Product Line

Standard Type

High-Resolution Type

TS Geared Type

Common Specifications

Motor Pin Arrangement

Drivers for 2-Phase/5-Phase Motors

Peripheral Equipment

SH Geared Type Frame Size 42 mm (Bipolar 4 lead wires)

Mini-Connector Type

13 mm

20 mm

28 mm

35 mm

42 mm

50 mm

51 mm

56.4 mm

60 mm

61 mm

85 mm

90 mm

Specifications

Product Name	Maximum Holding Torque [Nm]	Rotor Inertia J: kgm ²	Rated Current A/Phase	Voltage VDC	Winding Resistance Ω/Phase	Inductance mH/Phase	Basic Step Angle	Gear Ratio	Permissible Torque [Nm]	Speed Range r/min	Backlash arcmin	Recommended Driver Product Name*	
PKP243D15□2-SG3.6	0.2	36 × 10 ⁻⁷	1.5	0.83	0.55	0.77	0.5°	3.6	0.2	0 – 833	90 (1.5°)	CVD223FBR-K	
PKP243D23□2-SG3.6			2.3	0.87	0.38	0.41							
PKP243D15□2-SG7.2	0.4		0.55	1.5	0.83	0.55	0.77	0.25°	7.2	0.4			0 – 416
PKP243D23□2-SG7.2				2.3	0.87	0.38	0.41						
PKP243D15□2-SG9	0.5		0.55	1.5	0.83	0.55	0.77	0.2°	9	0.5			0 – 333
PKP243D23□2-SG9				2.3	0.87	0.38	0.41						
PKP243D15□2-SG10	0.56		0.55	1.5	0.83	0.55	0.77	0.18°	10	0.56			0 – 300
PKP243D23□2-SG10				2.3	0.87	0.38	0.41						
PKP243D15□2-SG18	0.8		0.55	1.5	0.83	0.55	0.77	0.1°	18	0.8			0 – 166
PKP243D23□2-SG18				2.3	0.87	0.38	0.41						
PKP243D15□2-SG36	0.8	0.55	1.5	0.83	0.55	0.77	0.05°	36	0.8	0 – 83			
PKP243D23□2-SG36			2.3	0.87	0.38	0.41							

● The box □ in the product name indicates the shaft **A** (single shaft) or **B** (double shaft).

*See "Drivers for 2-Phase / 5-Phase Motors" page for drivers that can be used in combination.

Note

● Be sure to set the driver current at or below the motor rated current. If the motor rated current is exceeded, the product will be damaged.

Speed – Torque Characteristics (Reference values) fs: Max. Starting Frequency

PKP243D15A2-SG3.6/PKP243D15B2-SG3.6 PKP243D15A2-SG7.2/PKP243D15B2-SG7.2 PKP243D15A2-SG9/PKP243D15B2-SG9

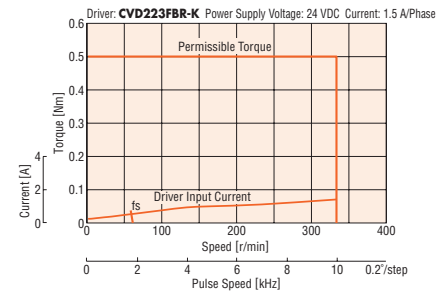
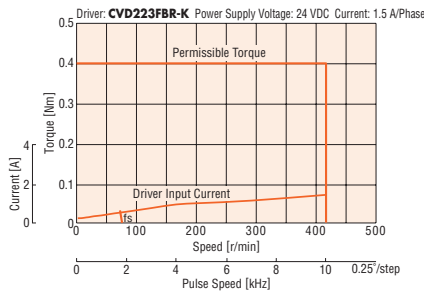
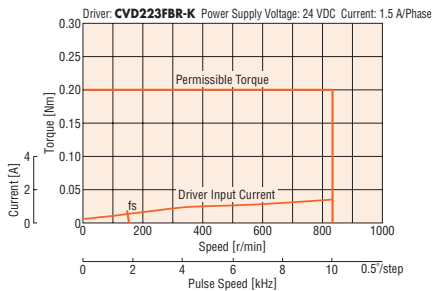

PKP243D15A2-SG10/PKP243D15B2-SG10

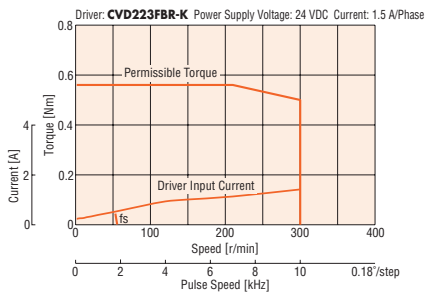

PKP243D15A2-SG18/PKP243D15B2-SG18

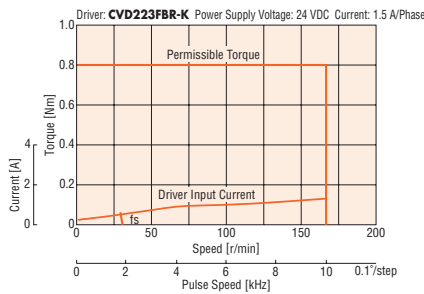

PKP243D15A2-SG36/PKP243D15B2-SG36

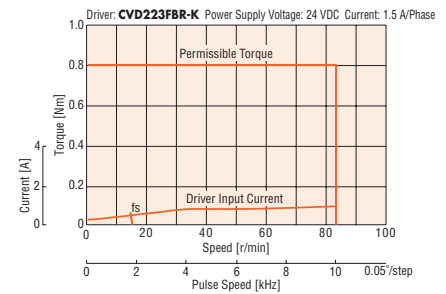

Note

● Data for the speed – torque characteristics is based on Oriental Motor's internal measurement conditions. If the conditions are changed, the characteristics may also change as a result.

● Depending on the driving conditions, a considerable amount of heat may be generated by the motor. Be sure to keep the motor case temperature at 100°C or less.

● The characteristics are the same when RS-485 communication type driver is used in combination.

Speed – Torque Characteristics (Reference values) fs: Max. Starting Frequency

PKP243D23A2-SG3.6/PKP243D23B2-SG3.6 PKP243D23A2-SG7.2/PKP243D23B2-SG7.2 PKP243D23A2-SG9/PKP243D23B2-SG9

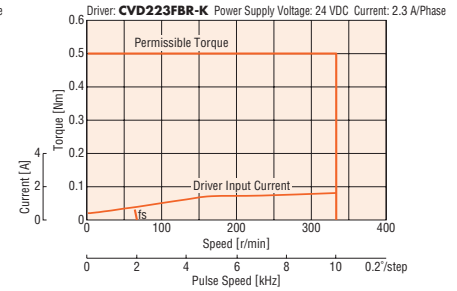
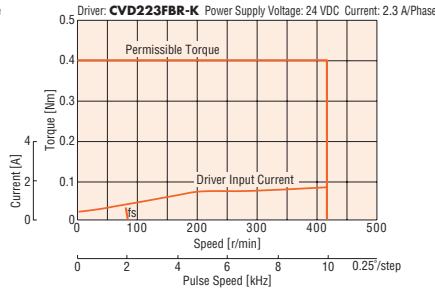
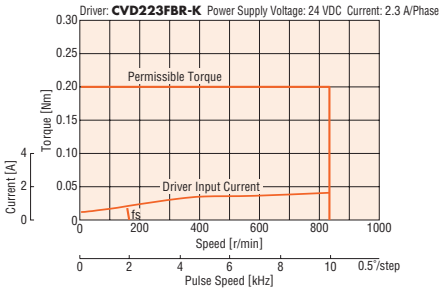

PKP243D23A2-SG10/PKP243D23B2-SG10 PKP243D23A2-SG18/PKP243D23B2-SG18 PKP243D23A2-SG36/PKP243D23B2-SG36

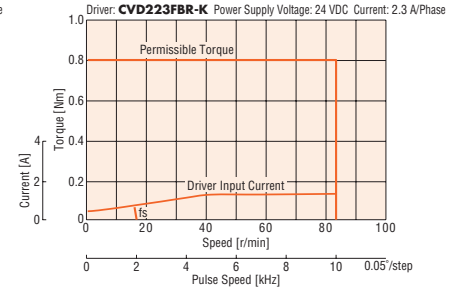
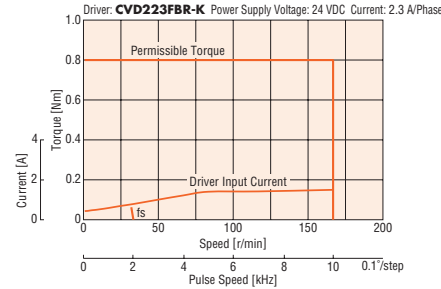
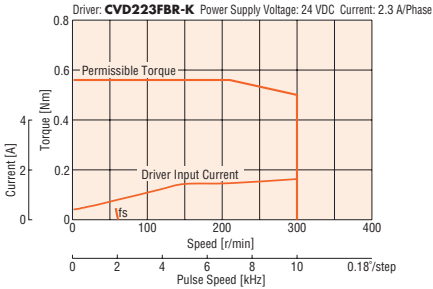

Note

- Data for the speed – torque characteristics is based on Oriental Motor's internal measurement conditions. If the conditions are changed, the characteristics may also change as a result.
- Depending on the driving conditions, a considerable amount of heat may be generated by the motor. Be sure to keep the motor case temperature at 100°C or less.
- The characteristics are the same when RS-485 communication type driver is used in combination.

Dimensions (Unit: mm)

Motors

Product Name	Gear Ratio	Mass [kg]
PKP243D15A2-SG□	3.6, 7.2, 9, 10, 18, 36	0.33
PKP243D15B2-SG□		
PKP243D23A2-SG□		
PKP243D23B2-SG□		

- The box □ in the product name indicates a number representing the gear ratio.

Applicable Connectors

Connector Housing: MDF97A-5S-3.5C (HIROSE ELECTRIC CO., LTD.)

Contact: MDF97-22SC (HIROSE ELECTRIC CO., LTD.)

Crimp Tool: HT801/MDF97-22S (HIROSE ELECTRIC CO., LTD.)

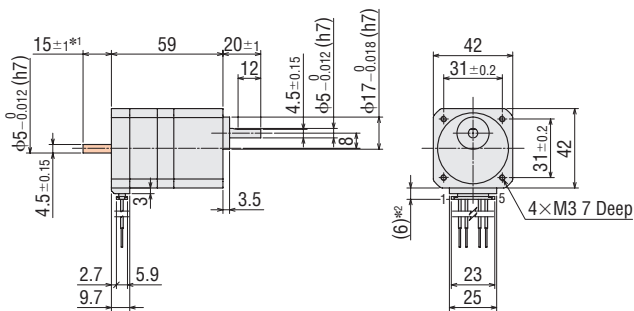

*1 The length of the shaft flat on the double shaft model is 15±0.25.

*2 With connection cable

- These dimensions are for double shaft motors.

For single shaft motors, ignore the shaded areas.

Connection Cables (Sold separately)

Motor Connection Cable

Product Name	Length L [m]
LC2B06E	0.6
LC2B10E	1

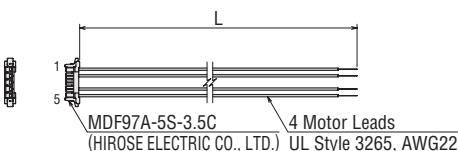

Inner Wiring Diagram of Motor

Wiring Diagram No.: Model A①

- See "Inner Wiring Diagram of Motor" page for the inner wiring diagram of the motor.

2-Phase
Motors
PKP

Features
Product
Line

Product
Number
Product Line

Standard
Type

High-
Resolution
Type

Flat
Type

SH Geared
Type

CS Geared
Type

Common
Specifications

Inner
Wiring
of Motor

5-Phase
Motors
PKP

Features
Product
Line

Product
Number
Product Line

Standard
Type

High-
Resolution
Type

TS Geared
Type

Common
Specifications

Motor
Pin
Arrangement

Drivers for
2-Phase/5-Phase
Motors

Peripheral
Equipment

SH Geared Type Frame Size 42 mm (Unipolar 5 lead wires)

Mini-Connector Type

13 mm

20 mm

28 mm

35 mm

42 mm

50 mm

51 mm

56.4 mm

60 mm

61 mm

85 mm

90 mm

Specifications

Product Name	Maximum Holding Torque [Nm]	Rotor Inertia J: kgm ²	Rated Current A/Phase	Voltage VDC	Winding Resistance Ω/Phase	Inductance mH/Phase	Basic Step Angle	Gear Ratio	Permissible Torque [Nm]	Speed Range r/min	Backlash arcmin
PKP243U09□2-SG3.6	0.2	36×10 ⁻⁷	0.95	2	2.1	1.8	0.5°	3.6	0.2	0 – 833	90 (1.5)
PKP243U09□2-SG7.2	0.4						0.25°	7.2	0.4	0 – 416	60 (1)
PKP243U09□2-SG9	0.5						0.2°	9	0.5	0 – 333	
PKP243U09□2-SG10	0.56						0.18°	10	0.56	0 – 300	
PKP243U09□2-SG18	0.8						0.1°	18	0.8	0 – 166	
PKP243U09□2-SG36	0.8						0.05°	36	0.8	0 – 83	

● The box □ in the product name indicates the shaft **A** (single shaft) or **B** (double shaft).

Note

● Be sure to set the driver current at or below the motor rated current. If the motor rated current is exceeded, the product will be damaged.

Speed – Torque Characteristics (Reference values) fs: Max. Starting Frequency

PKP243U09A2-SG3.6/PKP243U09B2-SG3.6 PKP243U09A2-SG7.2/PKP243U09B2-SG7.2 PKP243U09A2-SG9/PKP243U09B2-SG9

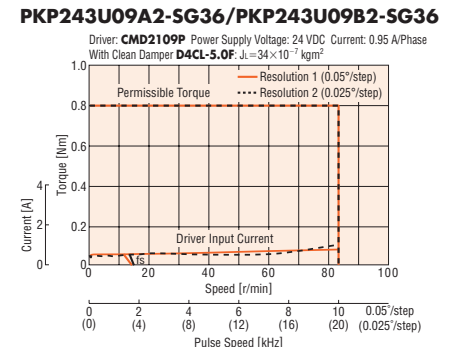
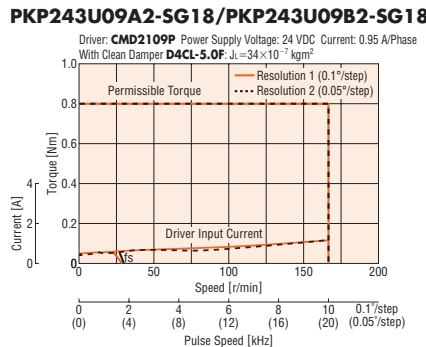
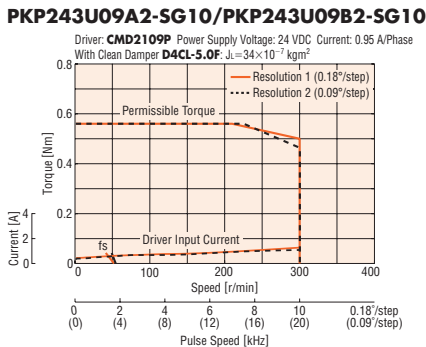
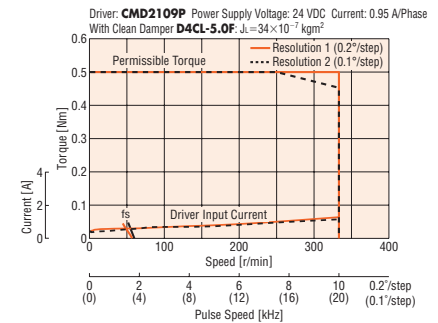
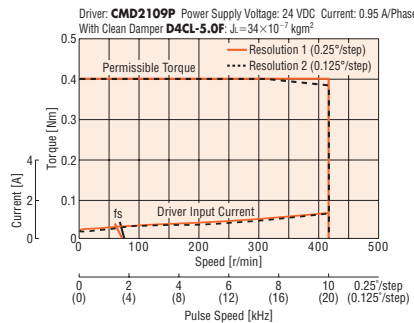
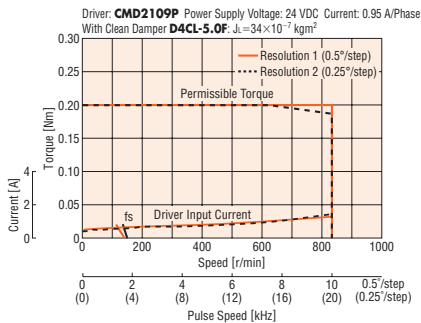

Note

- Data for the speed – torque characteristics is based on Oriental Motor's internal measurement conditions. If the conditions are changed, the characteristics may also change as a result.
- If there is a "clean damper" entry in the speed – torque characteristics, the data is for a double shaft motor when a clean damper is equipped.
- Depending on the driving conditions, a considerable amount of heat may be generated by the motor. Be sure to keep the motor case temperature at 100°C or less.

Dimensions (Unit: mm)

Motors

Product Name	Gear Ratio	Mass [kg]
PKP243U09A2-SG□	3.6, 7.2, 9, 10, 18, 36	0.33
PKP243U09B2-SG□		

● The box □ in the product name indicates a number representing the gear ratio.

Applicable Connectors

Connector Housing: MDF97A-5S-3.5C (HIROSE ELECTRIC CO., LTD.)

Contact: MDF97-22SC (HIROSE ELECTRIC CO., LTD.)

Crimp Tool: HT801/MDF97-22S (HIROSE ELECTRIC CO., LTD.)

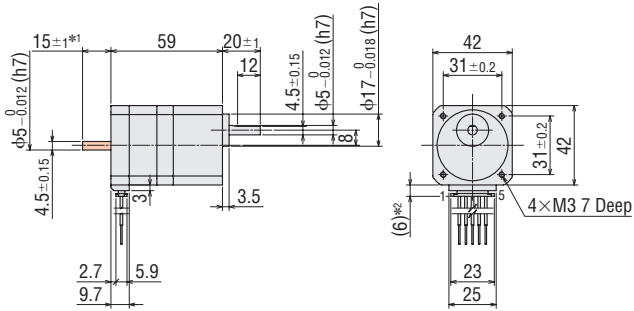

*1 The length of the shaft flat on the double shaft model is 15 ± 0.25 .

*2 With connection cable

● These dimensions are for double shaft motors.

For single shaft motors, ignore the shaded areas.

Connection Cables (Sold separately)

Motor Connection Cable

Product Name	Length L [m]
LC2U06E	0.6
LC2U10E	1

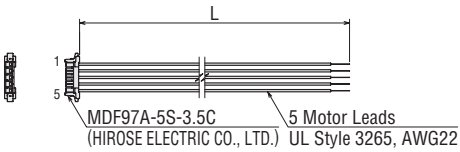

Inner Wiring Diagram of Motor

Wiring Diagram No.: Model A②

● See "Inner Wiring Diagram of Motor" page for the inner wiring diagram of the motor.

2-Phase
Motors
PKP

Features
Product
Line

Product
Number
Product Line

Standard
Type

High-
Resolution
Type

Flat
Type

SH Geared
Type

CS Geared
Type

Common
Specifications

Inner
Wiring
of Motor

5-Phase
Motors
PKP

Features
Product
Line

Product
Number
Product Line

Standard
Type

High-
Resolution
Type

TS Geared
Type

Common
Specifications

Motor
Pin
Arrangement

Drivers for
2-Phase/5-Phase
Motors

Peripheral
Equipment

SH Geared Type Frame Size 60 mm (Bipolar 4 lead wires)

Mini-Connector Type

13 mm

20 mm

28 mm

35 mm

42 mm

50 mm

51 mm

56.4 mm

60 mm

61 mm

85 mm

90 mm

Specifications

Product Name	Maximum Holding Torque [Nm]	Rotor Inertia J: kgm ²	Rated Current A/Phase	Voltage VDC	Winding Resistance Ω/Phase	Inductance mH/Phase	Basic Step Angle	Gear Ratio	Permissible Torque [Nm]	Speed Range r/min	Backlash arcmin	Recommended Driver Product Name*	
PKP264D14□2-SG3.6	1	140×10 ⁻⁷	1.4	2	1.4	3.1	0.5°	3.6	1	0 – 833	70 (1.17°)	CVD228BR-K	
PKP264D28□2-SG3.6			2.8	0.92	0.33	0.81							
PKP264D14□2-SG7.2	2		1.4	1.4	2	1.4	3.1	0.25°	7.2	2			0 – 416
PKP264D28□2-SG7.2				2.8	0.92	0.33	0.81						
PKP264D14□2-SG9	2.5		1.4	1.4	2	1.4	3.1	0.2°	9	2.5			0 – 333
PKP264D28□2-SG9				2.8	0.92	0.33	0.81						
PKP264D14□2-SG10	2.7		1.4	1.4	2	1.4	3.1	0.18°	10	2.7			0 – 300
PKP264D28□2-SG10				2.8	0.92	0.33	0.81						
PKP264D14□2-SG18	3		1.4	1.4	2	1.4	3.1	0.1°	18	3			0 – 166
PKP264D28□2-SG18				2.8	0.92	0.33	0.81						
PKP264D14□2-SG36	4		1.4	1.4	2	1.4	3.1	0.05°	36	4			0 – 83
PKP264D28□2-SG36				2.8	0.92	0.33	0.81						

● The box □ in the product name indicates the shaft **A** (single shaft) or **B** (double shaft).

*See "Drivers for 2-Phase / 5-Phase Motors" page for drivers that can be used in combination.

Note

● Be sure to set the driver current at or below the motor rated current. If the motor rated current is exceeded, the product will be damaged.

Speed – Torque Characteristics (Reference values) fs: Max. Starting Frequency

PKP264D14A2-SG3.6/PKP264D14B2-SG3.6 PKP264D14A2-SG7.2/PKP264D14B2-SG7.2 PKP264D14A2-SG9/PKP264D14B2-SG9

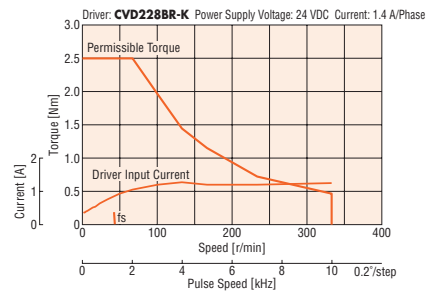
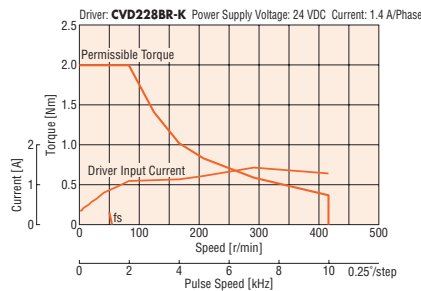
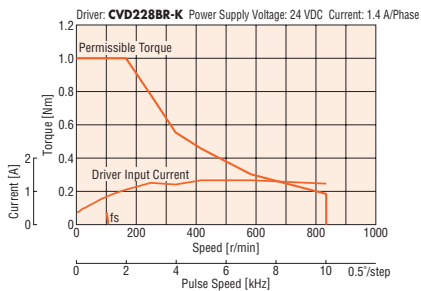

PKP264D14A2-SG10/PKP264D14B2-SG10

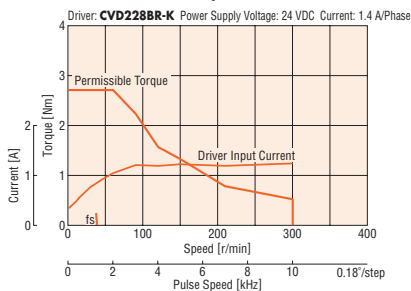

PKP264D14A2-SG18/PKP264D14B2-SG18

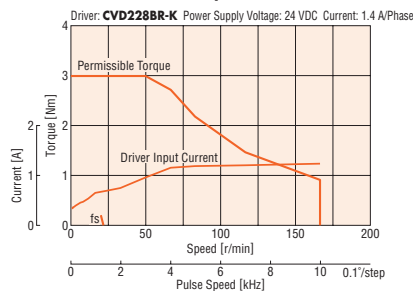

PKP264D14A2-SG36/PKP264D14B2-SG36

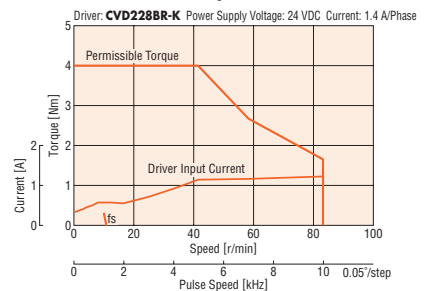

Note

● Data for the speed – torque characteristics is based on Oriental Motor's internal measurement conditions. If the conditions are changed, the characteristics may also change as a result.

● Depending on the driving conditions, a considerable amount of heat may be generated by the motor. Be sure to keep the motor case temperature at 100°C or less.

● The characteristics are the same when RS-485 communication type driver is used in combination.

Speed – Torque Characteristics (Reference values) f_s : Max. Starting Frequency

PKP264D28A2-SG3.6/PKP264D28B2-SG3.6 PKP264D28A2-SG7.2/PKP264D28B2-SG7.2 PKP264D28A2-SG9/PKP264D28B2-SG9

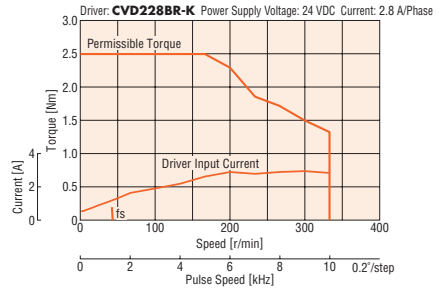
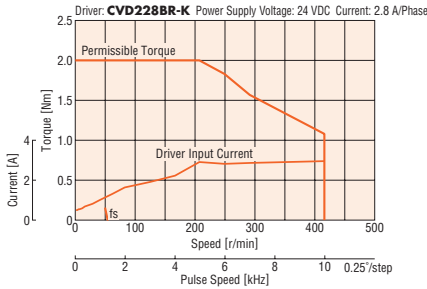
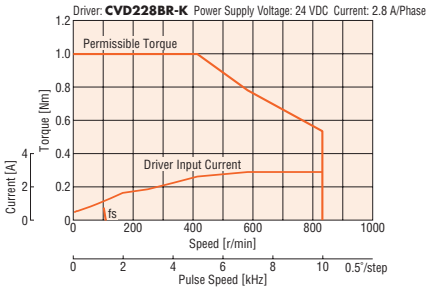

PKP264D28A2-SG10/PKP264D28B2-SG10

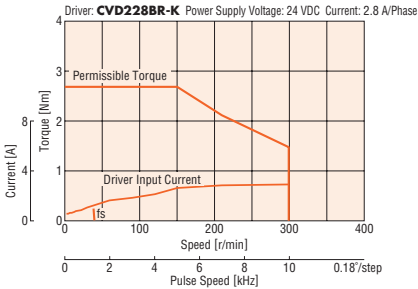

PKP264D28A2-SG18/PKP264D28B2-SG18

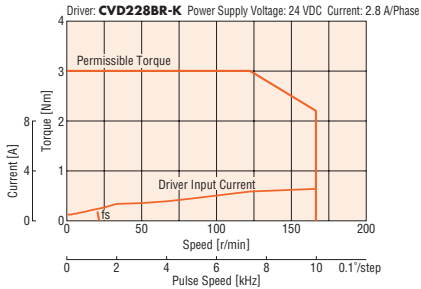

PKP264D28A2-SG36/PKP264D28B2-SG36

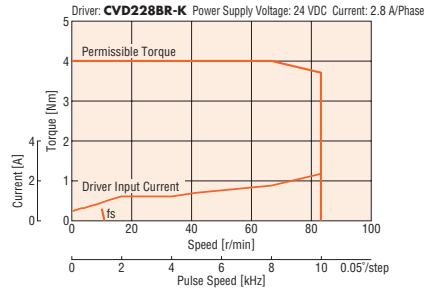

Note

- Data for the speed – torque characteristics is based on Oriental Motor's internal measurement conditions. If the conditions are changed, the characteristics may also change as a result.
- Depending on the driving conditions, a considerable amount of heat may be generated by the motor. Be sure to keep the motor case temperature at 100°C or less.
- The characteristics are the same when RS-485 communication type driver is used in combination.

Dimensions (Unit: mm)

Motors

Product Name	Gear Ratio	Mass [kg]
PKP264D14A2-SG□	3.6, 7.2, 9, 10, 18, 36	0.76
PKP264D14B2-SG□		
PKP264D28A2-SG□		
PKP264D28B2-SG□		

- The box □ in the product name indicates a number representing the gear ratio.

Applicable Connectors

Connector Housing: MDF97A-5S-3.5C (HIROSE ELECTRIC CO., LTD.)

Contact: MDF97-22SC (HIROSE ELECTRIC CO., LTD.)

Crimp Tool: HT801/MDF97-22S (HIROSE ELECTRIC CO., LTD.)

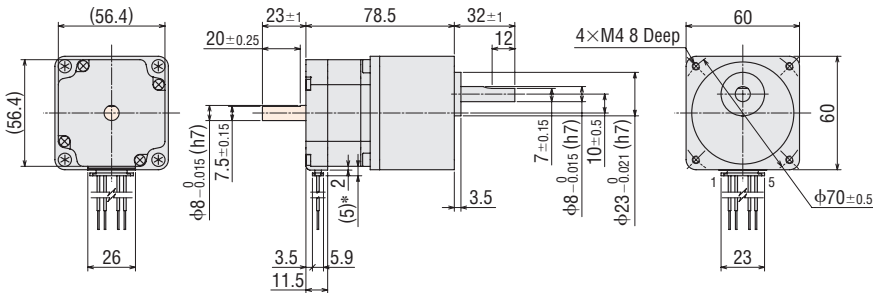

*With connection cable

- These dimensions are for double shaft motors.

For single shaft motors, ignore the shaded areas.

Connection Cables (Sold separately)

Motor Connection Cable

Product Name	Length L [m]
LC2B06E	0.6
LC2B10E	1

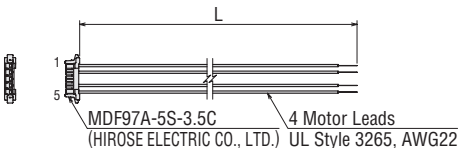

Inner Wiring Diagram of Motor

Wiring Diagram No.: Model A①

- See "Inner Wiring Diagram of Motor" page for the inner wiring diagram of the motor.

2-Phase
Motors
PKP

Features
Product
Line

Product
Number
Product Line

Standard
Type

High-
Resolution
Type

Flat
Type

SH Geared
Type

CS Geared
Type

Common
Specifications

Inner
Wiring
of Motor

5-Phase
Motors
PKP

Features
Product
Line

Product
Number
Product Line

Standard
Type

High-
Resolution
Type

TS Geared
Type

Common
Specifications

Motor
Pin
Arrangement

Drivers for
2-Phase/5-Phase
Motors

Peripheral
Equipment

SH Geared Type Frame Size 60 mm (Unipolar 5 lead wires)

Mini-Connector Type

13 mm

20 mm

28 mm

35 mm

42 mm

50 mm

51 mm

56.4 mm

60 mm

61 mm

85 mm

90 mm

Specifications

Product Name	Maximum Holding Torque [Nm]	Rotor Inertia J: kgm ²	Rated Current A/Phase	Voltage VDC	Winding Resistance Ω/Phase	Inductance mH/Phase	Basic Step Angle	Gear Ratio	Permissible Torque [Nm]	Speed Range r/min	Backlash arcmin
PKP264U10□2-SG3.6	1	140×10 ⁻⁷	1	2.9	2.9	4.2	0.5°	3.6	1	0 – 833	70 (1.17)
PKP264U20□2-SG3.6			2	1.5	0.76	1					
PKP264U10□2-SG7.2	2		1	2.9	2.9	4.2	0.25°	7.2	2	0 – 416	
PKP264U20□2-SG7.2			2	1.5	0.76	1					
PKP264U10□2-SG9	2.5		1	2.9	2.9	4.2	0.2°	9	2.5	0 – 333	
PKP264U20□2-SG9			2	1.5	0.76	1					
PKP264U10□2-SG10	2.7		1	2.9	2.9	4.2	0.18°	10	2.7	0 – 300	
PKP264U20□2-SG10			2	1.5	0.76	1					
PKP264U10□2-SG18	3		1	2.9	2.9	4.2	0.1°	18	3	0 – 166	
PKP264U20□2-SG18			2	1.5	0.76	1					
PKP264U10□2-SG36	4		1	2.9	2.9	4.2	0.05°	36	4	0 – 83	
PKP264U20□2-SG36			2	1.5	0.76	1					

● The box □ in the product name indicates the shaft **A** (single shaft) or **B** (double shaft).

Note

● Be sure to set the driver current at or below the motor rated current. If the motor rated current is exceeded, the product will be damaged.

Speed – Torque Characteristics (Reference values) fs: Max. Starting Frequency

PKP264U10A2-SG3.6/PKP264U10B2-SG3.6 PKP264U10A2-SG7.2/PKP264U10B2-SG7.2 PKP264U10A2-SG9/PKP264U10B2-SG9

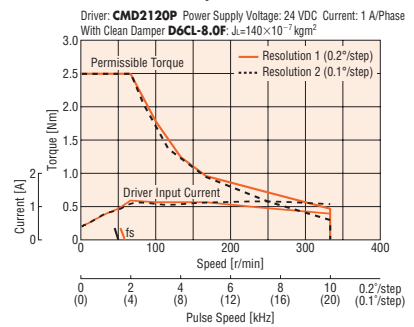
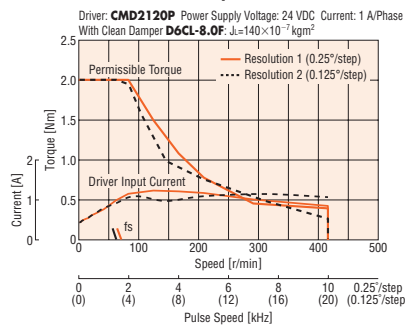
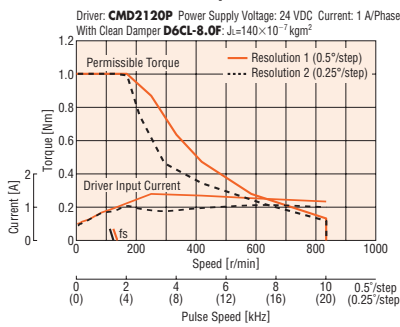

PKP264U10A2-SG10/PKP264U10B2-SG10

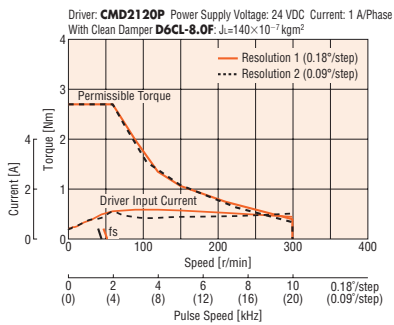

PKP264U10A2-SG18/PKP264U10B2-SG18

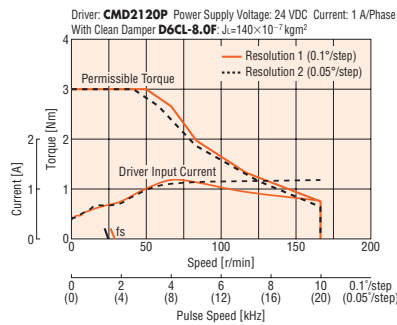

PKP264U10A2-SG36/PKP264U10B2-SG36

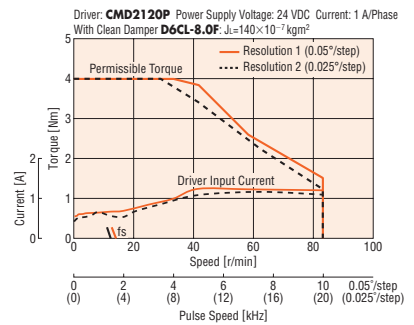

Note

● Data for the speed – torque characteristics is based on Oriental Motor's internal measurement conditions. If the conditions are changed, the characteristics may also change as a result.

● If there is a "clean damper" entry in the speed – torque characteristics, the data is for a double shaft motor when a clean damper is equipped.

● Depending on the driving conditions, a considerable amount of heat may be generated by the motor. Be sure to keep the motor case temperature at 100°C or less.

Speed – Torque Characteristics (Reference values) fs: Max. Starting Frequency

PKP264U20A2-SG3.6/PKP264U20B2-SG3.6 PKP264U20A2-SG7.2/PKP264U20B2-SG7.2 PKP264U20A2-SG9/PKP264U20B2-SG9

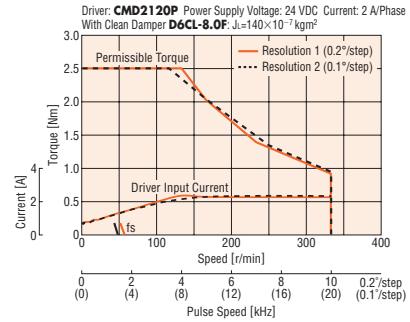
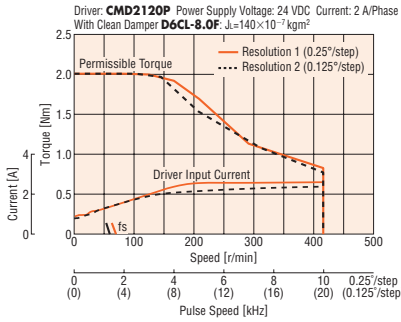
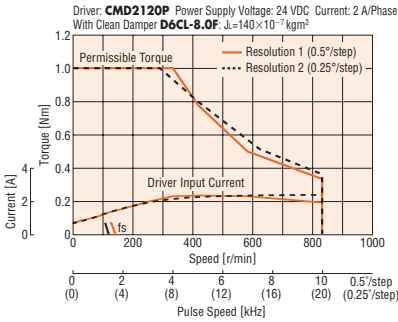

PKP264U20A2-SG10/PKP264U20B2-SG10

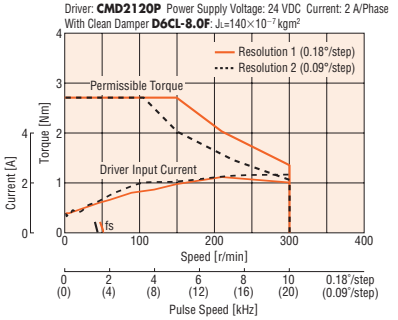

PKP264U20A2-SG18/PKP264U20B2-SG18

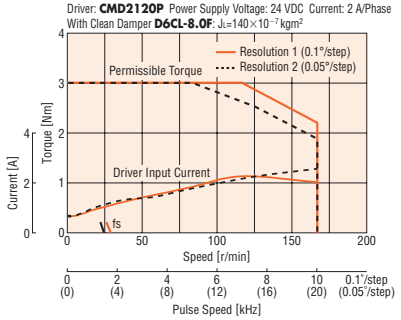

PKP264U20A2-SG36/PKP264U20B2-SG36

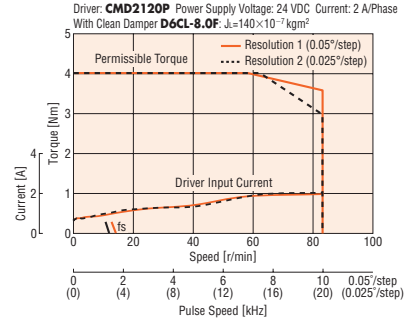

Note

- Data for the speed – torque characteristics is based on Oriental Motor's internal measurement conditions. If the conditions are changed, the characteristics may also change as a result.
- If there is a "clean damper" entry in the speed – torque characteristics, the data is for a double shaft motor when a clean damper is equipped.
- Depending on the driving conditions, a considerable amount of heat may be generated by the motor. Be sure to keep the motor case temperature at 100°C or less.

Dimensions (Unit: mm)

Motors

Product Name	Gear Ratio	Mass [kg]
PKP264U10A2-SG <input type="checkbox"/>	3.6, 7.2, 9, 10, 18, 36	0.76
PKP264U10B2-SG <input type="checkbox"/>		
PKP264U20A2-SG <input type="checkbox"/>		
PKP264U20B2-SG <input type="checkbox"/>		

● The box in the product name indicates a number representing the gear ratio.

Applicable Connectors

Connector Housing: MDF97A-5S-3.5C (HIROSE ELECTRIC CO., LTD.)

Contact: MDF97-22SC (HIROSE ELECTRIC CO., LTD.)

Crimp Tool: HT801/MDF97-22S (HIROSE ELECTRIC CO., LTD.)

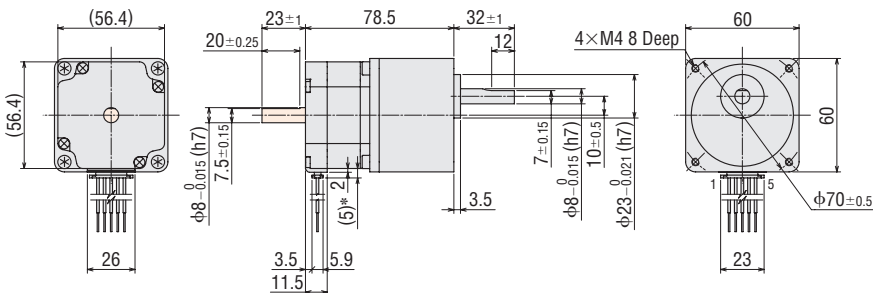

*With connection cable

● These dimensions are for double shaft motors.

For single shaft motors, ignore the shaded areas.

Connection Cables (Sold separately)

Motor Connection Cable

Product Name	Length L [m]
LC2U06E	0.6
LC2U10E	1

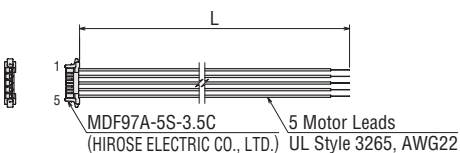

Inner Wiring Diagram of Motor

Wiring Diagram No.: Model A②

- See "Inner Wiring Diagram of Motor" page for the inner wiring diagram of the motor.

2-Phase
Motors
PKP

Features
Product
Line

Product
Number
Product Line

Standard
Type

High-
Resolution
Type

Flat
Type

SH Geared
Type

CS Geared
Type

Common
Specifications

Inner
Wiring
of Motor

5-Phase
Motors
PKP

Features
Product
Line

Product
Number
Product Line

Standard
Type

High-
Resolution
Type

T5 Geared
Type

Common
Specifications

Motor
Pin
Arrangement

Drivers for
2-Phase/5-Phase
Motors

Peripheral
Equipment

CS Geared Type Frame Size 28 mm (Bipolar 4 lead wires)

Connector Type

Specifications

Product Name	Maximum Holding Torque [Nm]	Rotor Inertia J: kgm ²	Rated Current A/Phase	Voltage VDC	Winding Resistance Ω/Phase	Inductance mH/Phase	Basic Step Angle	Gear Ratio	Permissible Torque [Nm]	Speed Range r/min	Backlash arcmin	Recommended Driver Product Name*
PKP223D15□-CS10	0.4	9×10 ⁻⁷	1.5	1.8	1.2	0.74	0.18	10	0.4	0 – 600	90 (1.5°)	CVD215BR-K
PKP223D15□-CS15	0.6						0.12	15	0.6	0 – 400		
PKP223D15□-CS20	0.8						0.09	20	0.8	0 – 300		

● The box □ in the product name indicates the shaft **A** (single shaft) or **B** (double shaft).

*See "Drivers for 2-Phase / 5-Phase Motors" page for drivers that can be used in combination.

Note

● Be sure to set the driver current at or below the motor rated current. If the motor rated current is exceeded, the product will be damaged.

Speed – Torque Characteristics (Reference values) fs: Max. Starting Frequency

PKP223D15A-CS10/PKP223D15B-CS10

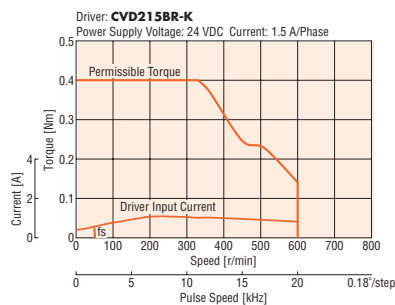

PKP223D15A-CS15/PKP223D15B-CS15

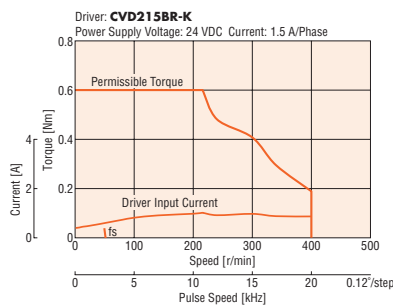

PKP223D15A-CS20/PKP223D15B-CS20

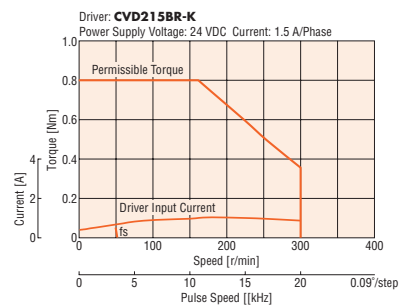

Note

- Data for the speed – torque characteristics is based on Oriental Motor's internal measurement conditions. If the conditions are changed, the characteristics may also change as a result.
- Depending on the driving conditions, a considerable amount of heat may be generated by the motor. Be sure to keep the motor case temperature at 100°C or less.
- The characteristics are the same when RS-485 communication type driver is used in combination.

Dimensions (Unit: mm)

● Motors

Product Name	Gear Ratio	Mass [kg]
PKP223D15A-CS□	10, 15, 20	0.17
PKP223D15B-CS□		

● The box □ in the product name indicates a number representing the gear ratio.

● Applicable Connectors

Connector Housing: 51065-0600 (Molex)

Contact: 50212-8100 (Molex)

Crimp Tool: 57176-5000 (Molex)

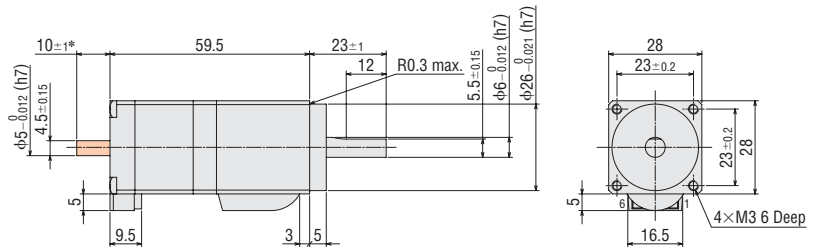

*The length of the shaft flat on the double shaft model is 10±0.25.

● These dimensions are for double shaft motors.

For single shaft motors, ignore the shaded areas.

● Connection Cables (Sold separately)

◇ Motor Connection Cable

Product Name	Length L [m]
LC2B06A	0.6
LC2B10A	1

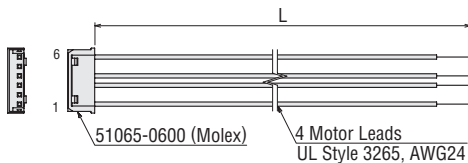

Inner Wiring Diagram of Motor

Wiring Diagram No.: Model B③

● See "Inner Wiring Diagram of Motor" page for the inner wiring diagram of the motor.

CS Geared Type Frame Size 28 mm (Unipolar 6 lead wires)

Connector Type

Specifications

Product Name	Maximum Holding Torque [Nm]	Rotor Inertia J: kgm ²	Rated Current A/Phase	Voltage VDC	Winding Resistance Ω/Phase	Inductance mH/Phase	Basic Step Angle	Gear Ratio	Permissible Torque [Nm]	Speed Range r/min	Backlash arcmin
PKP223U09□-CS10	0.4	9×10 ⁻⁷	0.95	2.66	2.8	1	0.18	10	0.4	0 – 600	90 (1.5)
PKP223U09□-CS15	0.6						0.12	15	0.6	0 – 400	
PKP223U09□-CS20	0.8						0.09	20	0.8	0 – 300	

● The box □ in the product name indicates the shaft **A** (single shaft) or **B** (double shaft).

Note

● Be sure to set the driver current at or below the motor rated current. If the motor rated current is exceeded, the product will be damaged.

Speed – Torque Characteristics (Reference values) fs: Max. Starting Frequency

PKP223U09A-CS10/PKP223U09B-CS10

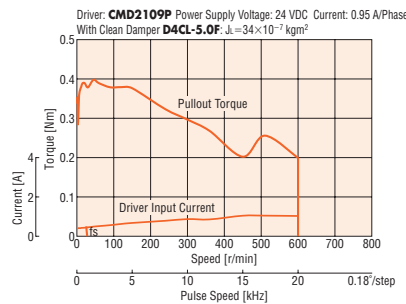

PKP223U09A-CS15/PKP223U09B-CS15

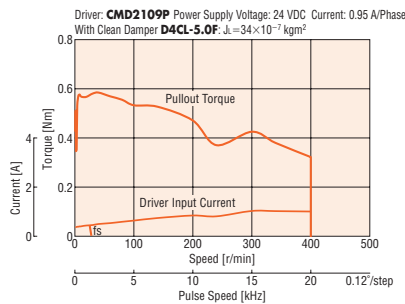

PKP223U09A-CS20/PKP223U09B-CS20

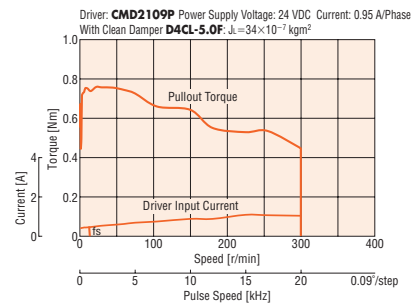

Note

- Data for the speed – torque characteristics is based on Oriental Motor's internal measurement conditions. If the conditions are changed, the characteristics may also change as a result.
- If there is a "clean damper" entry in the speed – torque characteristics, the data is for a double shaft motor when a clean damper is equipped.
- Depending on the driving conditions, a considerable amount of heat may be generated by the motor. Be sure to keep the motor case temperature at 100°C or less.

Dimensions (Unit: mm)

Motors

Product Name	Gear Ratio	Mass [kg]
PKP223U09A-CS□	10, 15, 20	0.17
PKP223U09B-CS□		

- The box □ in the product name indicates a number representing the gear ratio.
- Applicable Connectors
Connector Housing: 51065-0600 (Molex)
Contact: 50212-8100 (Molex)
Crimp Tool: 57176-5000 (Molex)

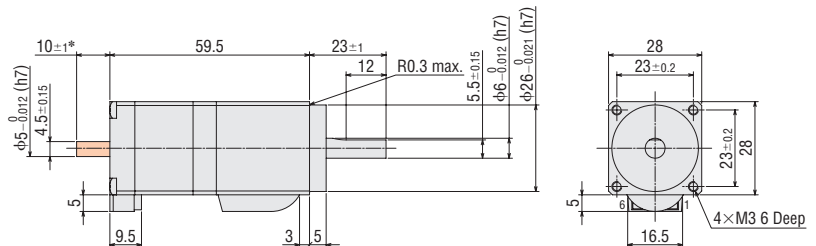

- * The length of the shaft flat on the double shaft model is 10±0.25.
- These dimensions are for double shaft motors.
For single shaft motors, ignore the shaded areas.

Connection Cables (Sold separately)

Motor Connection Cable

Product Name	Length L [m]
LC2U06A	0.6
LC2U10A	1

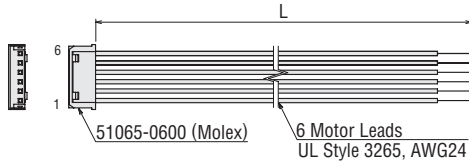

Inner Wiring Diagram of Motor

Wiring Diagram No.: Model B④

- See "Inner Wiring Diagram of Motor" page for the inner wiring diagram of the motor.

2-Phase Motors PKP

Features Product Line

Product Number Product Line

Standard Type

High-Resolution Type

Flat Type

SH Geared Type

CS Geared Type

Common Specifications

Inner Wiring of Motor

5-Phase Motors PKP

Features Product Line

Product Number Product Line

Standard Type

High-Resolution Type

TS Geared Type

Common Specifications

Motor Pin Arrangement

Drivers for 2-Phase/5-Phase Motors

Peripheral Equipment

CS Geared Type Frame Size 42 mm (Bipolar 4 lead wires)

Mini-Connector Type

Specifications

Product Name	Maximum Holding Torque [Nm]	Rotor Inertia J: kgm ²	Rated Current A/Phase	Voltage VDC	Winding Resistance Ω/Phase	Inductance mH/Phase	Basic Step Angle	Gear Ratio	Permissible Torque [Nm]	Speed Range r/min	Recommended Driver Product Name*	
PKP243D15□2-CS5	0.5	37×10 ⁻⁷	1.5	0.83	0.55	0.77	0.36°	5	0.5	0 – 600	CVD223FBR-K	
PKP243D23□2-CS5			2.3	0.87	0.38	0.41						
PKP243D15□2-CS10	1		1.5	0.83	0.55	0.77	0.18°	10	1			
PKP243D23□2-CS10			2.3	0.87	0.38	0.41						
PKP243D15□2-CS15	1.5		1.5	0.83	0.55	0.77	0.12°	15	1.5			0 – 200
PKP243D23□2-CS15			2.3	0.87	0.38	0.41						
PKP243D15□2-CS20	2	1.5	0.83	0.55	0.77	0.09°	20	2	0 – 150			
PKP243D23□2-CS20		2.3	0.87	0.38	0.41							

- The box □ in the product name indicates the shaft **A** (single shaft) or **B** (double shaft).
- The backlash is 1.5° for the gear ratio 5 and 1° for other gear ratios. (Reference value).
- *See "Drivers for 2-Phase / 5-Phase Motors" page for drivers that can be used in combination.

Note

- Be sure to set the driver current at or below the motor rated current. If the motor rated current is exceeded, the product will be damaged.

Speed – Torque Characteristics (Reference values) fs: Max. Starting Frequency

PKP243D15A2-CS5/PKP243D15B2-CS5

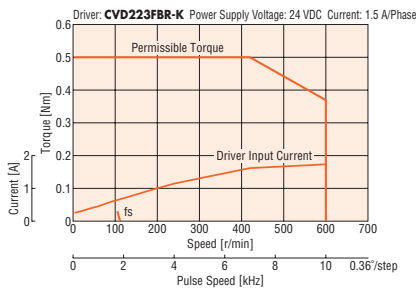

PKP243D15A2-CS10/PKP243D15B2-CS10

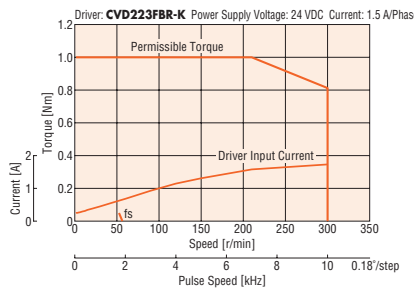

PKP243D15A2-CS15/PKP243D15B2-CS15

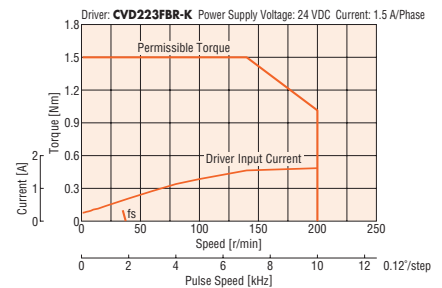

PKP243D15A2-CS20/PKP243D15B2-CS20

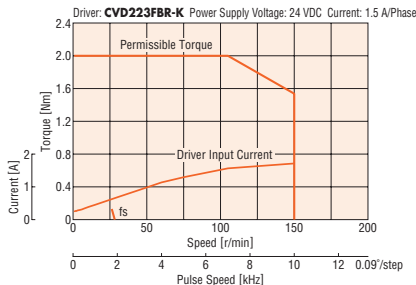

PKP243D23A2-CS5/PKP243D23B2-CS5

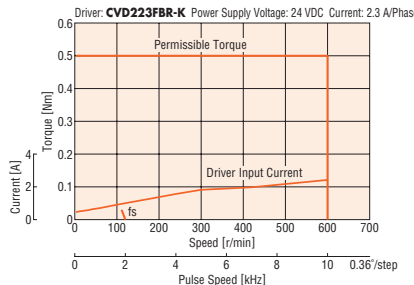

PKP243D23A2-CS10/PKP243D23B2-CS10

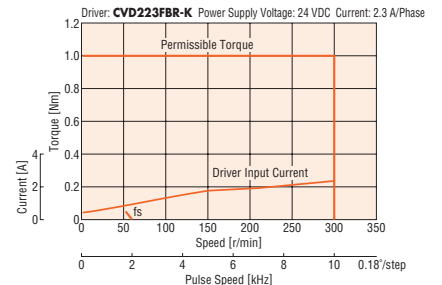

PKP243D23A2-CS15/PKP243D23B2-CS15

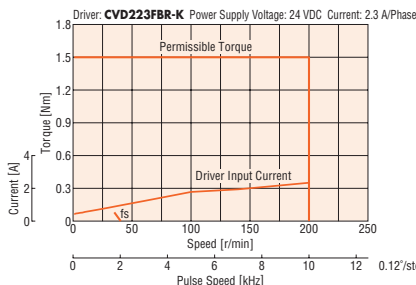

PKP243D23A2-CS20/PKP243D23B2-CS20

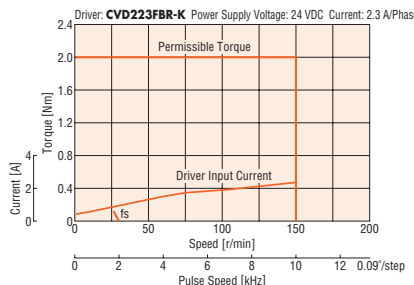

Note

- Data for the speed – torque characteristics is based on Oriental Motor's internal measurement conditions. If the conditions are changed, the characteristics may also change as a result.
- Depending on the driving conditions, a considerable amount of heat may be generated by the motor. Be sure to keep the motor case temperature at 100°C or less.
- The characteristics are the same when RS-485 communication type driver is used in combination.

Dimensions (Unit: mm)

Motors

Product Name	Gear Ratio	Mass [kg]
PKP243D15A2-CS□	5, 10, 15, 20	0.4
PKP243D15B2-CS□		
PKP243D23A2-CS□		
PKP243D23B2-CS□		

- The box □ in the product name indicates a number representing the gear ratio.
- Applicable Connectors
 Connector Housing: MDF97A-5S-3.5C (HIROSE ELECTRIC CO., LTD.)
 Contact: MDF97-22SC (HIROSE ELECTRIC CO., LTD.)
 Crimp Tool: HT801/MDF97-22S (HIROSE ELECTRIC CO., LTD.)

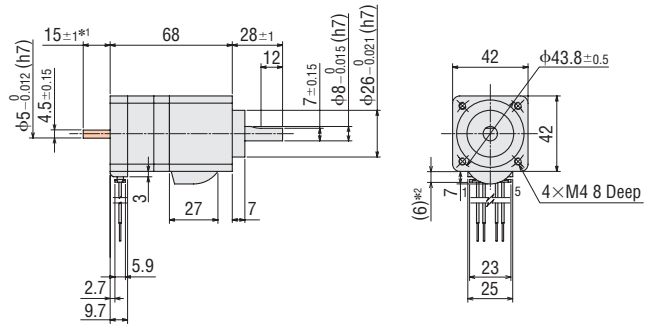

*1 The length of the shaft flat on the double shaft model is 15 ± 0.25 .

*2 With connection cable

● These dimensions are for double shaft motors.

For single shaft motors, ignore the shaded areas.

Connection Cables (Sold separately)

Motor Connection Cable

Product Name	Length L [m]
LC2B06E	0.6
LC2B10E	1

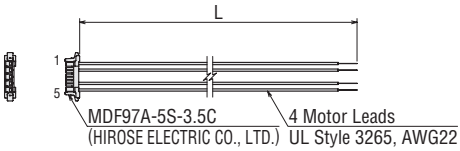

Inner Wiring Diagram of Motor

Wiring Diagram No.: Model A①

- See "Inner Wiring Diagram of Motor" page for the inner wiring diagram of the motor.

2-Phase
Motors
PKP

Features
Product
Line

Product
Number
Product Line

Standard
Type

High-
Resolution
Type

Flat
Type

SH Geared
Type

CS Geared
Type

Common
Specifications

Inner
Wiring
of Motor

5-Phase
Motors
PKP

Features
Product
Line

Product
Number
Product Line

Standard
Type

High-
Resolution
Type

TS Geared
Type

Common
Specifications

Motor
Pin
Arrangement

Drivers for
2-Phase/5-Phase
Motors

Peripheral
Equipment

CS Geared Type Frame Size 60 mm (Bipolar 4 lead wires)

Mini-Connector Type

13 mm

20 mm

28 mm

35 mm

42 mm

50 mm

51 mm

56.4 mm

60 mm

61 mm

85 mm

90 mm

Specifications

Product Name	Maximum Holding Torque [Nm]	Rotor Inertia J: kgm ²	Rated Current A/Phase	Voltage VDC	Winding Resistance Ω/Phase	Inductance mH/Phase	Basic Step Angle	Gear Ratio	Permissible Torque [Nm]	Speed Range r/min	Backlash arcmin	Recommended Driver Product Name*	
PKP264D14□2-CS5	1.3	140×10 ⁻⁷	1.4	2	1.4	3.1	0.36	5	1.3	0 – 600	70 (1.17°)	CVD228BR-K	
PKP264D28□2-CS5			2.8	0.92	0.33	0.81							
PKP264D14□2-CS10	2.7		0.18	1.4	2	1.4	3.1	0.18	10	2.7			0 – 300
PKP264D28□2-CS10				2.8	0.92	0.33	0.81						
PKP264D14□2-CS15	4		0.12	1.4	2	1.4	3.1	0.12	15	4			0 – 200
PKP264D28□2-CS15				2.8	0.92	0.33	0.81						
PKP264D14□2-CS20	4.5		0.09	1.4	2	1.4	3.1	0.09	20	4.5			0 – 150
PKP264D28□2-CS20				2.8	0.92	0.33	0.81						

● The box □ in the product name indicates the shaft **A** (single shaft) or **B** (double shaft).

*See "Drivers for 2-Phase / 5-Phase Motors" page for drivers that can be used in combination.

Note

● Be sure to set the driver current at or below the motor rated current. If the motor rated current is exceeded, the product will be damaged.

Speed – Torque Characteristics (Reference values) fs: Max. Starting Frequency

PKP264D14A2-CS5/ PKP264D14B2-CS5

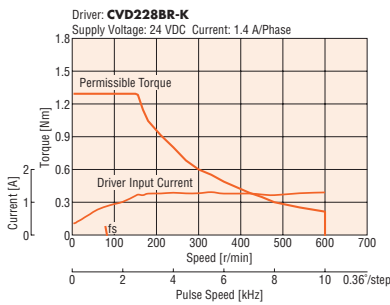

PKP264D14A2-CS10/ PKP264D14B2-CS10

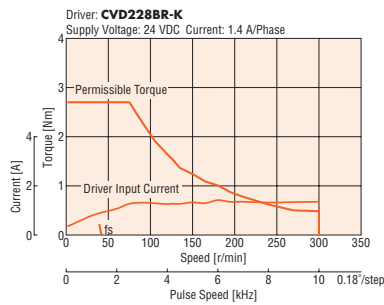

PKP264D14A2-CS15/ PKP264D14B2-CS15

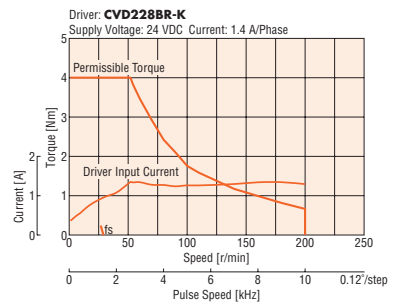

PKP264D14A2-CS20/ PKP264D14B2-CS20

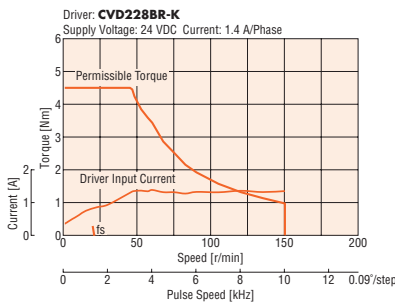

PKP264D28A2-CS5/ PKP264D28B2-CS5

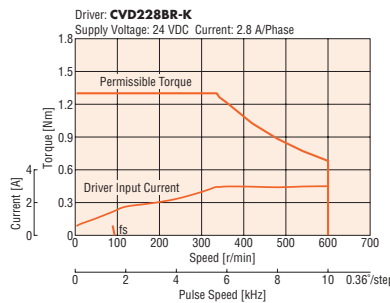

PKP264D28A2-CS10/ PKP264D28B2-CS10

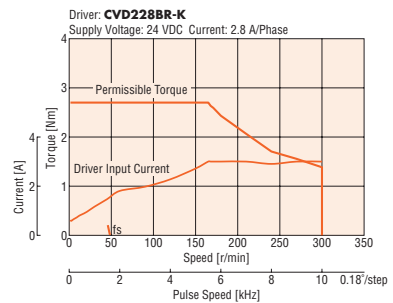

PKP264D28A2-CS15/ PKP264D28B2-CS15

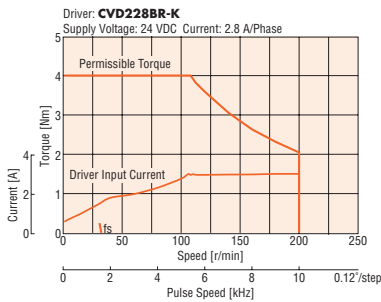

PKP264D28A2-CS20/ PKP264D28B2-CS20

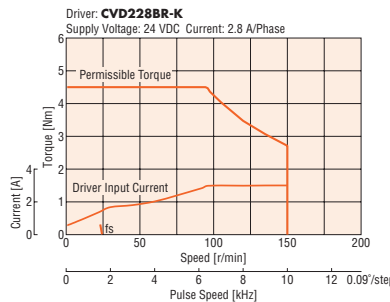

Note

● Data for the speed – torque characteristics is based on Oriental Motor's internal measurement conditions. If the conditions are changed, the characteristics may also change as a result.

● Depending on the driving conditions, a considerable amount of heat may be generated by the motor. Be sure to keep the motor case temperature at 100°C or less.

● The characteristics are the same when RS-485 communication type driver is used in combination.

Dimensions (Unit: mm)

Motors

Product Name	Gear Ratio	Mass [kg]
PKP264D14A2-CS□	5, 10, 15, 20	0.86
PKP264D14B2-CS□		
PKP264D28A2-CS□		
PKP264D28B2-CS□		

- The box □ in the product name indicates a number representing the gear ratio.
- Applicable Connectors
Connector Housing: MDF97A-5S-3.5C (HIROSE ELECTRIC CO., LTD.)
Contact: MDF97-22SC (HIROSE ELECTRIC CO., LTD.)
Crimp Tool: HT801/MDF97-22S (HIROSE ELECTRIC CO., LTD.)

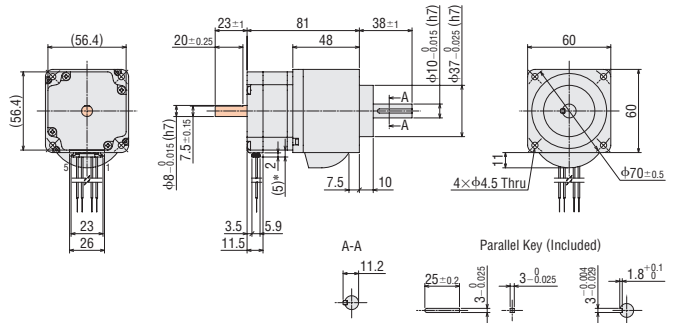

- *With connection cable
- These dimensions are for double shaft motors.
For single shaft motors, ignore the shaded areas.

Connection Cables (Sold separately)

Motor Connection Cable

Product Name	Length L [m]
LC2B06E	0.6
LC2B10E	1

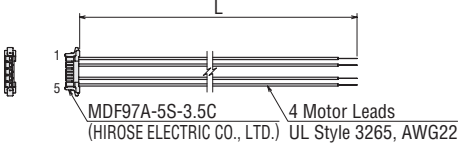

Inner Wiring Diagram of Motor

Wiring Diagram No.: Model A①

- See "Inner Wiring Diagram of Motor" page for the inner wiring diagram of the motor.

2-Phase
Motors
PKP

Features
Product
Line

Product
Number
Product Line

Standard
Type

High-
Resolution
Type

Flat
Type

SH Geared
Type

CS Geared
Type

Common
Specifications

Inner
Wiring
of Motor

5-Phase
Motors
PKP

Features
Product
Line

Product
Number
Product Line

Standard
Type

High-
Resolution
Type

TS Geared
Type

Common
Specifications

Motor
Pin
Arrangement

Drivers for
2-Phase/5-Phase
Motors

Peripheral
Equipment

Common Specifications

General Specifications

Specification		Motor
Thermal Class		130(B)
Insulation Resistance		100 MΩ or more when 500 VDC megger is applied between the windings and the case under normal ambient temperature and humidity.
Dielectric Strength		No abnormalities are observed, even when applying voltage between the windings and the case for 1 minute under normal ambient temperature and humidity with the following conditions. • PKP203 : 0.3 kVAC 50/60 Hz • Frame size 42 mm max., PKP262 : 0.5 kVAC 50/60 Hz • Frame size 50 mm min.: 1.0 kVAC 50/60 Hz • PKP29 : 1.5 kVAC 50/60 Hz
Operating Environment	Ambient Temperature	-10 to +50°C (Non-Freezing) [0 to +40°C for Flat Type with Harmonic Gear]
	Ambient Humidity	85% or less (Non-Condensing)
	Surrounding Atmosphere	No corrosive gas or dust. No water or oil.
Temperature Rise		Winding temperature rise 80°C max. (Based on Oriental Motor's measurement conditions)
Stop Position Accuracy*1		±3 arcmin (±0.05°) [PKP21 , PKP242 , and PKP262 are ±5 arcmin (±0.083°), PK26 □J, and PK26 □JD are ±2 arcmin (±0.034°)]
Shaft Runout		0.05 mm T.I.R.*4
Radial Play*2		0.025 mm Max. (Load 5 N) [PKP203 is Load 2.5 N]
Axial Play*3		0.075 mm Max. (Load 10 N) [PKP203 and PKP21 are Load 1 N, PKP22 □, PKP242 , and PKP262 are Load 2.5 N]
Concentricity of Installing Pilot to the Shaft		0.075 mm T.I.R.*4
Perpendicularity of Installation Surface to the Shaft		0.075 mm T.I.R.*4

*1 This value is for full step under no load. (The value changes with the size of the load.)

*2 Radial Play: Displacement in shaft position in the radial direction when a 5 N (**PKP203** is 2.5 N) load is applied in the vertical direction to the tip of the motor shaft.

*3 Axial Play: Displacement in shaft position in the axial direction when a 10 N (**PKP203** and **PKP21** are 1 N, **PKP22**□, **PKP242**, and **PKP262** are 2.5 N) load is applied to the motor shaft in the axial direction.

*4 T.I.R. (Total Indicator Reading): The total dial gauge reading when the measurement section is rotated one revolution centered on the reference axis center.

Note

- Do not measure the insulation resistance or perform a dielectric strength test while the motor and driver are connected. Also, do not conduct these tests on the motor encoder section.

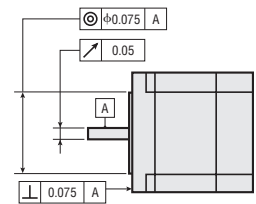

Electromagnetic Brake Specifications

Product Name	PKP22	PKP23 · PKP24	PKP26	PKP26	PKP26
Brake Type	Power Off Activated Type				
Power Supply Voltage	24 VDC ±5%				
Power Supply Current	A	0.05	0.07	0.23	0.18
Static Friction Torque	Nm	0.08	0.3	1.5	0.8
Brake Operating Time	ms	20*			
Brake Releasing Time	ms	50*			
Time Rating	Continuous				

*Value when the included surge suppressor is used. [Recommended surge suppressor: Z15D121 (SEMITEC)]

Encoder Specifications

Encoder Product Name	R2EL	R2FL
Resolution	200 P/R	400 P/R
Output Circuit Type	Line Driver*	
Output Mode	Incremental	
Output Signal	A Phase, B Phase, and Z Phase (3ch)	
Power Supply Voltage	5 VDC ±10%	
Current	30 mA max.	

- An encoder whose output circuit type is voltage output is also available. For details, please contact the nearest Oriental Motor sales office.

*26C31 equivalent

Motor Frame Size

□13 mm

□20 mm

□28 mm

□35 mm

□42 mm

□50 mm

□51 mm

□56.4 mm

□60 mm

□61 mm

□85 mm

□90 mm

Permissible Radial Load and Permissible Axial Load

Unit: N

Type	Motor Frame Size	Product Name	Gear Ratio	Permissible Radial Load					Permissible Axial Load
				Distance from Shaft End [mm]					
				0	5	10	15	20	
Standard Type	13 mm	PKP203	-	5	6	-	-	-	1
	20 mm	PKP213, PKP214		12	15	-	-	-	3
	28 mm	PKP223, PKP225		25	34	52	-	-	5
	35 mm	PKP233, PKP235		20	25	34	52	-	10
	42 mm	PKP243, PKP244, PKP245, PKP246		20	25	34	52	-	10
		PKP243□2, PKP244□2, PKP245□2, PKP246□2		35	44	58	85	-	15
	50 mm	PKP254, PKP256, PKP258		61	73	90	110	-	20
	56.4 mm	PKP264, PKP266, PKP268		61	73	90	110	160	20
		PKP264□2, PKP266□2, PKP268□2		90	100	130	180	270	30
60 mm	PK264J, PK266J, PK267J, PK269J	50	60	75	100	150	20		
85 mm	PKP296, PKP299, PKP2913	260	290	340	390	480	60		
High-Resolution Type	28 mm	PKP223, PKP225	-	25	34	52	-	-	5
	42 mm	PKP243, PKP244		20	25	34	52	-	10
		PKP243□2, PKP244□2, PKP245□2, PKP246□2		35	44	58	85	-	15
	56.4 mm	PKP264, PKP266, PKP268		61	73	90	110	160	20
		PKP264□2, PKP266□2, PKP268□2		90	100	130	180	270	30
Flat Type · Standard	42 mm	PKP242	-	20	25	34	-	-	5
	60 mm	PKP262							
Flat Type with Harmonic Gear	51 mm	PKP242	50, 100	-	-	-	-	-	200
	61 mm	PKP262							450
SH Geared Type	28 mm	PKP223	7.2, 9, 10, 18, 36	15	17	20	23	-	10
	42 mm	PKP243	3.6, 7.2, 9, 10, 18, 36	10	15	20	30	-	15
	60 mm	PKP264	3.6, 7.2, 9, 10	30	40	50	60	70	30
18, 36		80	100	120	140	160			
CS Geared Type	28 mm	PKP223	10, 15, 20	30	37	50	73	-	30
	42 mm	PKP243	5, 10, 15, 20	59	68	80	96	-	40
	60 mm	PKP264		160	170	200	220	260	70

Radial Load and Axial Load

Distance from Shaft End [mm]

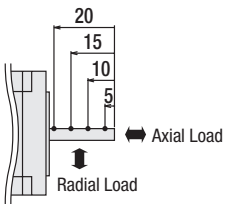

Permissible Moment Load of Flat Type with Harmonic Gear

When an eccentric load is applied to the output flange-installation surface, the load moment acts on the bearing. Use the following formula to check whether the axial load and load moment are within specifications.

Product Name	Gear Ratio	Permissible Axial Load [N]	Permissible Moment Load [Nm]	Constant a [m]
PKP242-H□	50, 100	200	8.5	0.0129
PKP262-H□S	50, 100	450	10.1	0.0140

m: Load mass [kg]	ΔF : Load on output flange surface [N]
g: Gravitational acceleration [m/s ²]	F _s : Permissible axial load [N]
F: External force [N]	
L: Overhang distance [m]	ΔM : Load moment [Nm]
a: Constant [m]	M: Permissible moment load [Nm]

Example 1: An external force F [N] is applied at L [m] overhang position in a horizontal direction from the center of the output flange

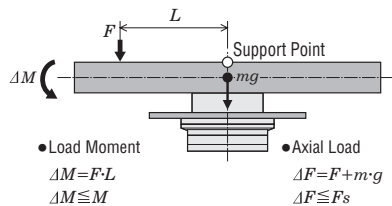

Example 2: An external force F [N] is applied at L [m] overhang position in a vertical direction from the output flange-installation surface

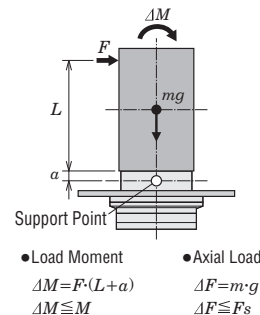

2-Phase Motors PKP

Features Product Line

Product Number Product Line

Standard Type

High-Resolution Type

Flat Type

SH Geared Type

CS Geared Type

Common Specifications

Inner Wiring of Motor

5-Phase Motors PKP

Features Product Line

Product Number Product Line

Standard Type

High-Resolution Type

TS Geared Type

Common Specifications

Motor Pin Arrangement

Drivers for 2-Phase/5-Phase Motors

Peripheral Equipment

Details of the Flat Type with Harmonic Gear

Principle and Structure

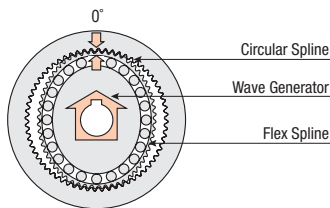

Details of the Accuracy

Unlike the conventional spur gear gearhead, the harmonic gear has no backlash. The harmonic gear has many teeth in simultaneous meshing engagement, and is designed to average out the effects of tooth pitch error and cumulative pitch error on rotation accuracy to ensure high positioning accuracy. Also, harmonic gears have high gear ratio, so that the torsion when the load torque is applied to the output shaft is much smaller than a single motor and other geared motor, and the rigidity is high. High rigidity is less subject to load fluctuation and enables stable positioning. When the high positioning accuracy and rigidity are required, refer to the following characteristics.

Angular Transmission Accuracy

Angular transmission error is the difference between the theoretical rotation angle of the output shaft, as calculated from the input pulse count, and actual rotation angle. Represented as the difference between the min. value and max. value in the set of measurements taken for a single rotation of the output shaft starting from an arbitrary position.

Product Name	Angular Transmission Accuracy [arcmin]
PKP242-H□	2 (0.034°)
PKP262-H□S	1.5 (0.025°)

● Values in no-load condition (reference of gear part)

Torque – Torsion Characteristics

In actual applications, there is always frictional load, and displacement is produced as a result of this load. If the frictional load is constant, the displacement will be constant for unidirectional operation. However, in bidirectional operation, double the displacement is produced over a round trip. This displacement can be estimated from the following torque – torsion characteristics.

This displacement occurs when an external force is applied as the gear is stopped, or when the gear is driven under a frictional load. The slope can be approximated with the spring constant in the following 3 classes, depending on the size of the load torque, and can be estimated through calculation.

1. Load torque T_L is T_1 max.

$$\theta = \frac{T_L}{K_1} \text{ [min]}$$

2. Load torque T_L exceeds T_1 and is T_2 max.

$$\theta = \theta_1 + \frac{T_L - T_1}{K_2} \text{ [min]}$$

3. Load torque T_L exceeds T_2

$$\theta = \theta_2 + \frac{T_L - T_2}{K_3} \text{ [min]}$$

The torsion angle of the harmonic gear alone is calculated according to the size of the load torque.

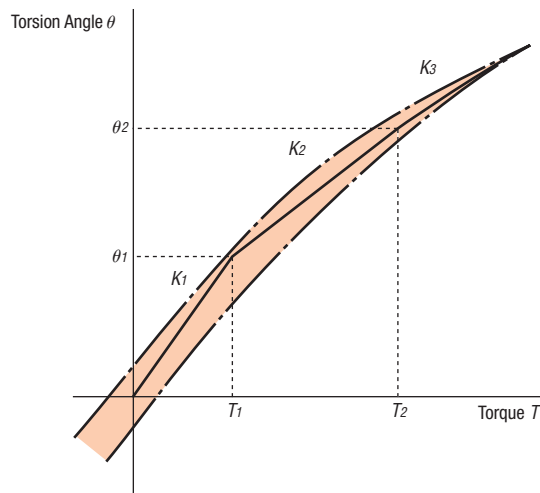

Torsion Angle – Torque Characteristics

Values for Determining Torsion Angle

Product Name	Item	Gear Ratio	T_1	K_1	θ_1	T_2	K_2	θ_2	K_3
			[Nm]	Nm/min	min	[Nm]	Nm/min	min	Nm/min
PKP242-H50	50	50	0.29	0.13	2.3	0.75	0.19	4.5	0.24
	100	100	0.29	0.26	1.1	0.75	0.29	2.8	0.35
PKP262-H50S	50	50	0.8	0.64	1.2	2	0.87	2.8	0.93
	100	100	0.8	0.79	1	2	0.99	2.1	1.28

Motor Frame Size

□13 mm

□20 mm

□28 mm

□35 mm

□42 mm

□50 mm
□51 mm

□56.4 mm

□60 mm
□61 mm

□85 mm
□90 mm

Inner Wiring Diagram of Motor and Rotation Direction

Inner Wiring Diagram

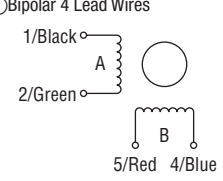
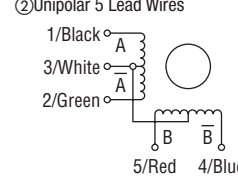
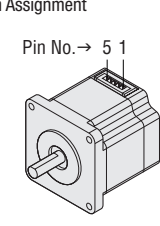
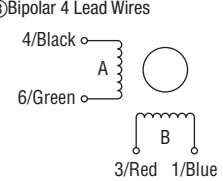
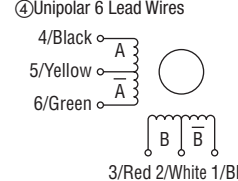
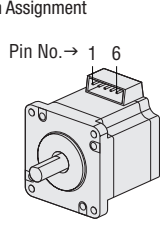
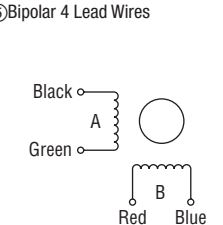
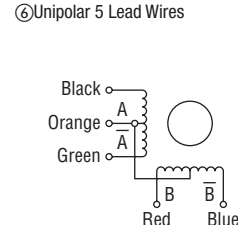
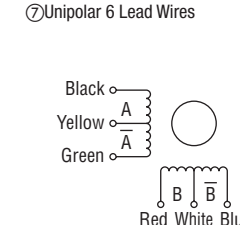
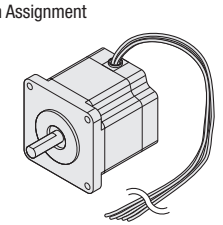
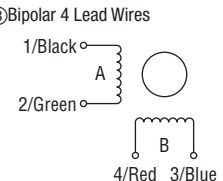
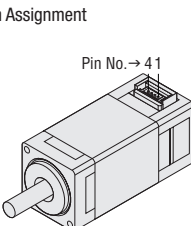
Motor Model Type	Wiring Diagram/Pin Assignment			
Model A Mini-Connector Type	① Bipolar 4 Lead Wires 	② Unipolar 5 Lead Wires 	Pin Assignment 	
Model B Connector Type	③ Bipolar 4 Lead Wires 	④ Unipolar 6 Lead Wires 	Pin Assignment 	
Model C Lead Wire Type	⑤ Bipolar 4 Lead Wires 	⑥ Unipolar 5 Lead Wires 	⑦ Unipolar 6 Lead Wires 	Pin Assignment  Colors of Motor Lead Wires: Blue, White, Red, Black, Yellow, and Green
Model D Mini-Connector Type	⑧ Bipolar 4 Lead Wires 	Pin Assignment 		

Rotation Direction

When excited in the order shown in the table below, the motor rotates in the CW direction as viewed from the output shaft side.

• Bipolar

STEP	Black	Green	Red	Blue
1	-	+	+	-
2	-	+	-	+
3	+	-	-	+
4	+	-	+	-

• Unipolar

STEP	A	\bar{A}	B	\bar{B}
1	ON		ON	
2		ON	ON	
3		ON		ON
4	ON			ON

Rotation Direction of Geared Motor

The direction of rotation of the gear output shaft with respect to the standard type motor output shaft varies depending on the geared type and gear ratio. Check in the table below.

Check in the table below.

Geared Type		Gear Ratio	Rotation Direction of the Gear Output Shaft
SH Geared Type	Frame Size 28 mm	7.2, 36	Same as the motor output shaft
		9, 10, 18	Opposite as the motor output shaft
	Frame Size 42 mm, 60 mm	3.6, 7.2, 9, 10	Same as the motor output shaft
		18, 36	Opposite as the motor output shaft
		Frame Size 90 mm	3.6, 7.2, 9, 10, 18
36	Opposite as the motor output shaft		
CS Geared Type		5, 10, 15, 20	Same as the motor output shaft
Flat Type with Harmonic Gear		50, 100	Opposite as the motor output shaft

• Standard Type Motor

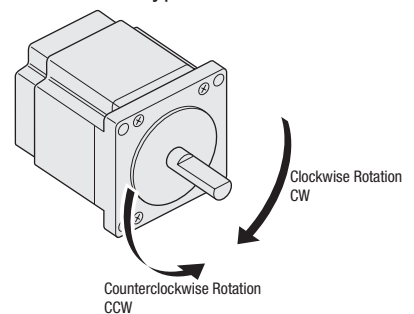

5-Phase Stepper Motors PKP Series

Motor
Frame Size

13 mm

20 mm

28 mm

35 mm

42 mm

50 mm

51 mm

56.4 mm

60 mm

61 mm

85 mm

90 mm

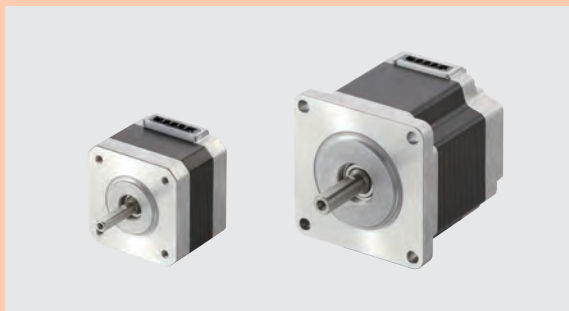

This is a high torque and low vibration stepper motor with a basic step angle of 0.72° (resolution of 500 steps per revolution). High Positioning accuracy is possible, as well as low vibration and reduced noise. (A separate dedicated driver is required to operate each motor.)

Features

High Accuracy

Since the step angle of 5-Phase Stepper Motors in the **PKP Series** is at 0.72° (high-resolution type at 0.36°) and the stopping accuracy is at $\pm 0.05^\circ$, highly accurate positioning is possible. In addition, the stop position accuracy controlled by a microstep driver has almost the same high accuracy as that controlled by a full-step driver.

● General 2-Phase Motor

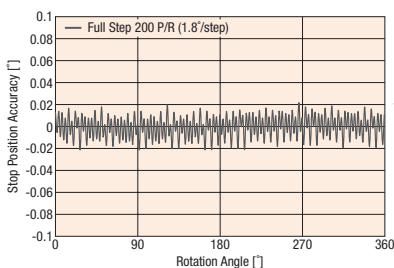

Stopping accuracy gets worse with Microstep

● 5-Phase PKP Series

(Driver: 5-phase **CVD** driver)

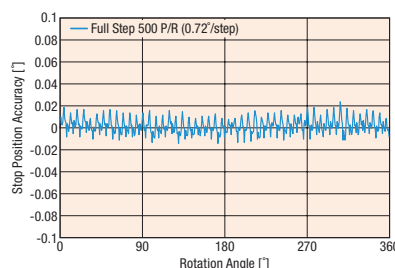

Stopping accuracy does not get worse with Microstep

PKP Series Highly accurate positioning for 5-phase is possible

Low Vibration and Reduced Noise

Because the basic step angle is small at 0.72° (0.36° for high-resolution type), the vibrations and noise are lower than the 2-phase stepper motor with a basic step angle of 1.8° . Also, vibrations and noise can be further reduced with the driver of the microstep drive.

● Example of 2-Phase Stepper Motor Vibration Characteristics

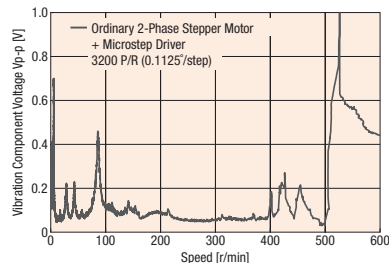

PKP Series Vibration characteristics for 5-phase are further improved

● Example of 5-Phase Stepper Motor Vibration Characteristics

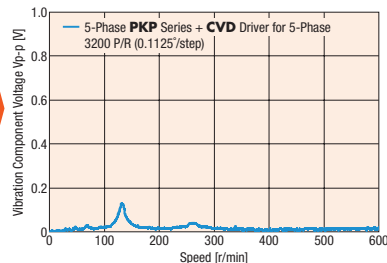

Lineup of Products Using Compact, Flat Connectors





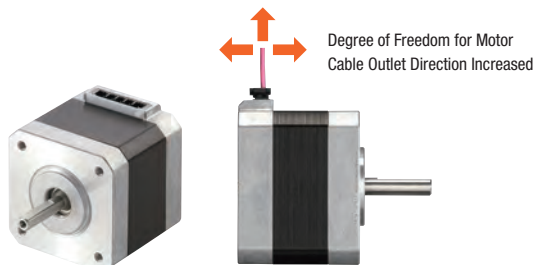







The product line offers products that use compact, flat connectors. The degree of freedom for the motor cable outlet direction has been increased, because the outlet direction points upward.

● The connector configuration depends on the motor. Check the details in the motor dimensions.



Product Line

—: Not Offered in This Product Line

Type (Basic Step Angle)	Features	Frame Size					
		20 mm	28 mm	42 mm	56.4 mm	60 mm	85 mm
Standard Type (0.72°)	<ul style="list-style-type: none"> Standard model High torque, low vibration 	 *1					 *1 Lead Wire Type
High-Resolution Type (0.36°)	<ul style="list-style-type: none"> Resolution double that of standard type Results in high positioning accuracy and reduced vibration 	—	—		—		—
Standard Type with Encoder (0.72°)	<ul style="list-style-type: none"> En resolution 500 P/R, A, B, Z (3 ch) signal output Uses compact encoder Encoder with superior noise resistance due to line driver (differential output) output 	 *1	—	 *2		 *2	—

*1 This is the conventional **PK** Series.

*2 With frame sizes of 42 mm and 60 mm, a product line with resolution of 1000 P/R is also available.

2-Phase Motors PKP

Features Product Line

Product Number Product Line

Standard Type

High-Resolution Type

Flat Type

SH Geared Type

CS Geared Type

Common Specifications

Inner Wiring of Motor

5-Phase Motors PKP

Features Product Line

Product Number Product Line

Standard Type

High-Resolution Type

TS Geared Type

Common Specifications

Motor Pin Arrangement

Drivers for 2-Phase/5-Phase Motors

Peripheral Equipment

- Motor Frame Size
- 13 mm
 - 20 mm
 - 28 mm
 - 35 mm
 - 42 mm
 - 50 mm
 - 51 mm
 - 56.4 mm
 - 60 mm
 - 61 mm
 - 85 mm
 - 90 mm

System Configuration

● Combination of the 5-Phase Stepper Motor PKP Series and the CVD Series Pulse Input Type Driver

An example of a system configuration using a host control device (with built-in pulse generator function) is shown below. Motors, drivers, and connection cables must be ordered individually.

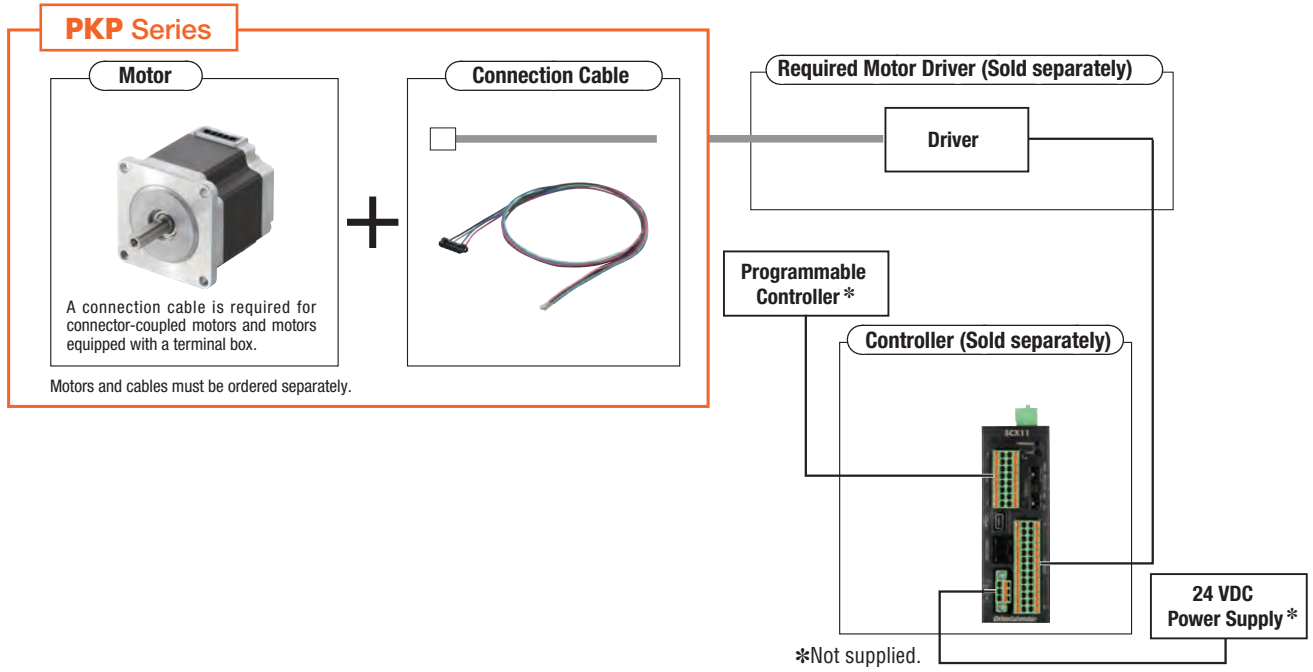

2-Phase
Motors
PKP

Features
Product
Line

Product
Number
Product Line

Standard
Type

High-
Resolution
Type

Flat
Type

SH Geared
Type

CS Geared
Type

Common
Specifications

Inner
Wiring
of Motor

5-Phase
Motors
PKP

Features
Product
Line

Product
Number
Product Line

Standard
Type

High-
Resolution
Type

TS Geared
Type

Common
Specifications

Motor
Pin
Arrangement

Drivers for
2-Phase/5-Phase
Motors

Peripheral
Equipment

- Motor Frame Size
- 13 mm
- 20 mm
- 28 mm
- 35 mm
- 42 mm
- 50 mm
□51 mm
- 56.4 mm
- 60 mm
□61 mm
- 85 mm
□90 mm

Product Number

● Motor

◇ Frame Size 20 mm, 85 mm

Standard Type

PK 5 1 3 P A

① ② ③ ④ ⑤ ⑧

PK 5 9 6 H N A W

① ② ③ ④ ⑥ ⑦ ⑧ ⑪

Standard Type with Encoder

PK 5 1 3 P A - R2G L

① ② ③ ④ ⑤ ⑧ ⑨ ⑩

◇ Frame Size 28 mm, 42 mm, 56.4 mm, 60 mm

Standard Type, High-Resolution Type

PKP 5 6 6 F N 24 A 2

① ② ③ ④ ⑤ ⑦ ⑧ ⑨ ⑩

PKP 5 4 4 M N 18 A

① ② ③ ④ ⑥ ⑦ ⑧ ⑨

Standard Type with Encoder

PKP 5 6 6 F N 24 A 2 - R2G L

① ② ③ ④ ⑤ ⑦ ⑧ ⑨ ⑩ ⑪ ⑫

● Driver

For details about drivers refer to page 128.

● Connection Cable

◇ Motor Connection Cable

LC 5 N 06 E

① ② ③ ④ ⑤

◇ Encoder Connection Cable

LC E 08 A - 006

① ② ③ ④ ⑤

①	Series Name	PK: PK Series
②		5: 5-Phase
③	Motor Frame Size	1: 20 mm 9: 85 mm
④	Motor Case Length	
⑤	Motor Classification	
⑥	Motor Specifications	Blank: Standard Specifications H: High-Speed Specifications
⑦	Number of Lead Wires	N: 5
⑧	Shaft	A: Single Shaft B: Double Shaft
⑨	Encoder Resolution	R2G: 500 P/R
⑩	Encoder Output Circuit Type	L: Line Driver Output
⑪	Cable Type	Blank: Connector-Coupled Type W: Lead Wire Type

①	Series Name	PKP: PKP Series
②		5: 5-Phase
③	Motor Frame Size	2: 28 mm 4: 42 mm 6: 56.4 mm (60 mm when the Motor Identification is F)
④	Motor Case Length	
⑤	Motor Identification	F: Motor Frame Size 60 mm
⑥	Motor Type	Blank: Standard Type M: High-Resolution Type
⑦	Number of Lead Wires	N: 5
⑧	Motor Winding Specifications	
⑨	Shaft	A: Single Shaft B: Double Shaft
⑩	Reference Number	
⑪	Encoder Resolution	R2G: 500 P/R
⑫	Encoder Output Circuit Type	L: Line Driver Output*

● A product with a shaft diameter of $\phi 6.35$ mm is also available.
For details, please contact the nearest Oriental Motor sales office.
*An encoder whose output circuit type is voltage output is also available.
For details, please contact the nearest Oriental Motor sales office.

①	Cable	LC: Lead Wire with Connector
②		5: 5-Phase
③	Cable Type	N: 5-Phase
④	Cable Length	06: 0.6 m 10: 1 m
⑤	Reference Number	

①	Cable	LC: Lead Wire with Connector
②	Cable Type	E: Encoder Cable
③	Applicable Model	08: Line Driver Output*
④	Reference Number	
⑤	Cable Length	006: 0.6 m

*The voltage output cable is also available.
For details, please contact the nearest Oriental Motor sales office.

Product Line

A connection cable is required for connector-coupled motors.

Motors, drivers, and cables are must be ordered individually. Refer to page 142 for connection cable.

Motor

Standard Type

Product Name (Single Shaft)	Product Name (Double Shaft)
PK513PA	PK513PB
PKP523N12A	PKP523N12B
PKP525N12A	PKP525N12B
PKP543N18A2	PKP543N18B2
PKP544N18A2	PKP544N18B2
PKP544N18A	PKP544N18B
PKP545N18A2	PKP545N18B2
PKP546N18A2	PKP546N18B2
PKP546N18A	PKP546N18B
PKP564N28A2	PKP564N28B2
PKP566N28A2	PKP566N28B2
PKP568N28A2	PKP568N28B2
PKP564FN24A2	PKP564FN24B2
PKP564FN38A2	PKP564FN38B2
PKP566FN24A2	PKP566FN24B2
PKP566FN38A2	PKP566FN38B2
PKP569FN24A2	PKP569FN24B2
PKP569FN38A2	PKP569FN38B2
PK596HNAW	PK596HNBW
PK599HNAW	PK599HNBW
PK5913HNAW	PK5913HNBW

Standard Type with Encoder

Product Name
PK513PA-R2GL
PKP543N18A2-R2GL
PKP544N18A2-R2GL
PKP545N18A2-R2GL
PKP546N18A2-R2GL
PKP564N28A2-R2GL
PKP566N28A2-R2GL
PKP568N28A2-R2GL
PKP564FN24A2-R2GL
PKP564FN38A2-R2GL
PKP566FN24A2-R2GL
PKP566FN38A2-R2GL
PKP569FN24A2-R2GL
PKP569FN38A2-R2GL

High-Resolution Type

Product Name (Single Shaft)	Product Name (Double Shaft)
PKP544MN18A	PKP544MN18B
PKP546MN18A	PKP546MN18B
PKP564FMN24A	PKP564FMN24B
PKP566FMN24A	PKP566FMN24B
PKP569FMN24A	PKP569FMN24B

Driver

For details about drivers refer to page 128.

Connection Cable

For the applicable motor of the connection cable, refer to the dimension page of each product.

Some cables that can be directly connected to the recommended driver are also available. See page 142.

Included

Type	Included	Parallel Key	Motor Installation Screw	Operating Manual
Standard Type		—	—	—
High-Resolution Type		—	—	—
With Encoder		—	—	1 Set

How to Read Specifications

Maximum Holding Torque	: This is the maximum holding torque (holding force) the motor has when power is supplied (at rated current) but the motor is not rotating. (With geared types, the value of holding torque considers the permissible strength of the gear.)
Permissible Torque	: The permissible torque represents the maximum value limited by the mechanical strength of the output gear shaft when operated at a constant speed.
Maximum Instantaneous Torque	: This is the maximum torque that can be applied to the gear output shaft during acceleration/deceleration such when an inertial load is started and stopped.

2-Phase
Motors
PKP

Features
Product
Line

Product
Number
Product Line

Standard
Type

High-
Resolution
Type

Flat
Type

SH Geared
Type

CS Geared
Type

Common
Specifications

Inner
Wiring
of Motor

5-Phase
Motors
PKP

Features
Product
Line

Product
Number
Product Line

Standard
Type

High-
Resolution
Type

TS Geared
Type

Common
Specifications

Motor
Pin
Arrangement

Drivers for
2-Phase/5-Phase
Motors

Peripheral
Equipment

Standard Type Frame Size 20 mm

Connector Type

13 mm

20 mm

28 mm

35 mm

42 mm

50 mm

51 mm

56.4 mm

60 mm

61 mm

85 mm

90 mm

Specifications

Product Name		Maximum Holding Torque [Nm]	Rotor Inertia J: kgm ²	Rated Current A/Phase	Winding Resistance Ω/Phase	Basic Step Angle	Recommended Driver Product Name*
Single Shaft	Double Shaft						
PK513PA	PK513PB	0.0231	1.6×10^{-7}	0.35	3.5	0.72°	CVD503BR-K

*See "Drivers for 2-Phase / 5-Phase Motors" page for drivers that can be used in combination.

Note

- Be sure to set the driver current at or below the motor rated current. If the motor rated current is exceeded, the product will be damaged.

Speed – Torque Characteristics (Reference values) fs: Max. Starting Frequency

PK513PA/PK513PB

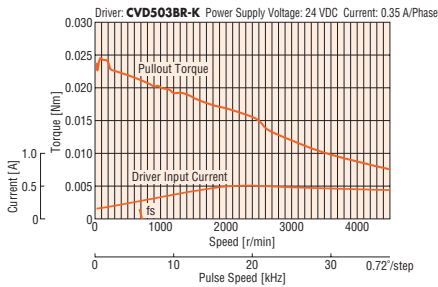

Note

- Data for the speed – torque characteristics is based on Oriental Motor's internal measurement conditions. If the conditions are changed, the characteristics may also change as a result.
- Depending on the driving conditions, a considerable amount of heat may be generated by the motor. Be sure to keep the motor case temperature at 100°C max.
- The characteristics are the same when RS-485 communication type driver is used in combination.

Dimensions (Unit: mm)

Motor

Product Name	Mass [kg]
PK513PA	0.05
PK513PB	

Applicable Connectors

Connector Housing: 51065-0500 (Molex)

Contact: 50212-8100 (Molex)

Crimping Tool: 57176-5000 (Molex)

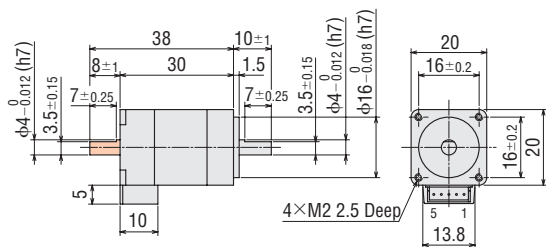

- These dimensions are for double shaft motors.

For single shaft motors, ignore the shaded in the areas.

Connection Cable (Sold separately)

Motor Connection Cable

Product Name	Length L [m]
LC5N06A	0.6
LC5N10A	1

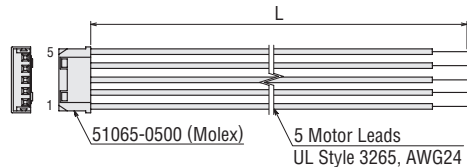

Motor Pin Assignments

Motor Pin Assignments: Model B

- Refer to the motor pin arrangement page for information on motor pin arrangement.

Standard Type with Encoder Frame Size 20 mm

Connector Type

Specifications

Product Name	Maximum Holding Torque [Nm]	Rotor Inertia J: kgm ²	Rated Current A/Phase	Winding Resistance Ω/Phase	Basic Step Angle	Recommended Driver Product Name*
PK513PA-R2GL	0.0231	1.66×10 ⁻⁷	0.35	3.5	0.72°	CVD503BR-K

● See "Common Specifications" page for encoder specifications.

*See "Drivers for 2-Phase / 5-Phase Motors" page for drivers that can be used in combination.

Note

● Be sure to set the driver current at or below the motor rated current. If the motor rated current is exceeded, the product will be damaged.

Speed – Torque Characteristics (Reference values) fs: Max. Starting Frequency

PK513PA-R2GL

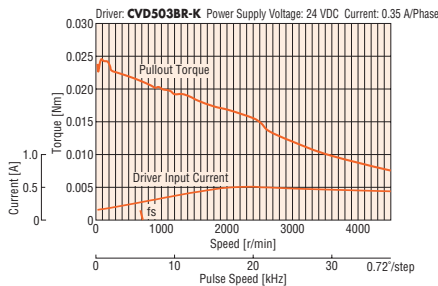

Note

● Data for the speed – torque characteristics is based on Oriental Motor's internal measurement conditions. If the conditions are changed, the characteristics may also change as a result.

● For the type with an encoder, to protect the encoder, be sure to keep the motor case temperature at 85°C max.

● The characteristics are the same when RS-485 communication type driver is used in combination.

Dimensions (Unit: mm)

Motor

Product Name	Mass [kg]
PK513PA-R2GL	0.06

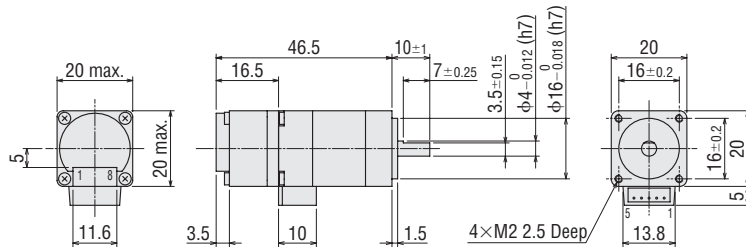

● Applicable Connectors (Molex)

	Motor	Encoder
Connector Housing	51065-0500	51021-0800
Contact	50212-8100	50079-8100
Crimp Tool	57176-5000	57177-5000

Connection Cable (Sold separately)

◇ Motor Connection Cable

Product Name	Length L [m]
LC5N06A	0.6
LC5N10A	1

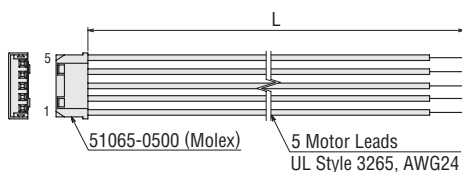

Connection Cable (Included)

◇ Encoder Connection Cable

Product Name	Length L [m]
LCE08A-006	0.6

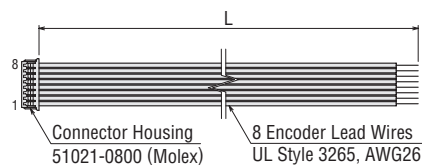

Motor Pin Assignments

Motor Pin Assignments: Model B

● Refer to the motor pin arrangement page for information on motor pin arrangement.

2-Phase Motors
PKP

Features Product Line

Product Number Product Line

Standard Type

High-Resolution Type

Flat Type

SH Geared Type

CS Geared Type

Common Specifications

Inner Wiring of Motor

5-Phase Motors
PKP

Features Product Line

Product Number Product Line

Standard Type

High-Resolution Type

TS Geared Type

Common Specifications

Motor Pin Arrangement

Drivers for 2-Phase/5-Phase Motors

Peripheral Equipment

Standard Type Frame Size 28 mm

Connector Type

13 mm

20 mm

28 mm

35 mm

42 mm

50 mm

51 mm

56.4 mm

60 mm

61 mm

85 mm

90 mm

Specifications

Product Name		Maximum Holding Torque [Nm]	Rotor Inertia J: kgm ²	Rated Current A/Phase	Winding Resistance Ω/Phase	Basic Step Angle	Recommended Driver Product Name*
Single Shaft	Double Shaft						
PKP523N12A	PKP523N12B	0.052	9×10 ⁻⁷	1.2	0.63	0.72°	CVD512BR-K
PKP525N12A	PKP525N12B	0.091	18×10 ⁻⁷		1		

*See "Drivers for 2-Phase / 5-Phase Motors" page for drivers that can be used in combination.

Note

- Be sure to set the driver current at or below the motor rated current. If the motor rated current is exceeded, the product will be damaged.

Speed – Torque Characteristics (Reference values) fs: Max. Starting Frequency

PKP523N12A/PKP523N12B

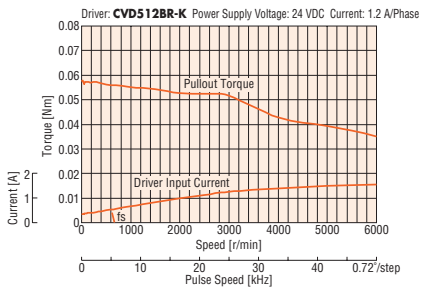

PKP525N12A/PKP525N12B

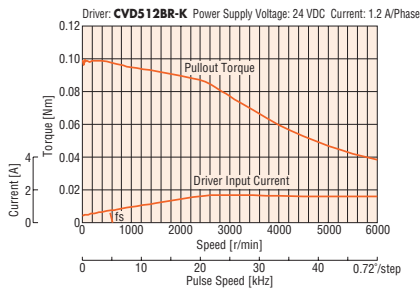

Note

- Data for the speed – torque characteristics is based on Oriental Motor's internal measurement conditions. If the conditions are changed, the characteristics may also change as a result.
- Depending on the driving conditions, a considerable amount of heat may be generated by the motor. Be sure to keep the motor case temperature at 100°C max.
- The characteristics are the same when RS-485 communication type driver is used in combination.

Dimensions (Unit: mm)

Motor

Product Name	L1	L2	Mass [kg]
PKP523N12A	32	—	0.11
PKP523N12B		42	
PKP525N12A	51.5	—	0.2
PKP525N12B		61.5	

Applicable Connectors

Connector Housing: 51065-0500 (Molex)
Contact: 50212-8100 (Molex)
Crimping Tool: 57176-5000 (Molex)

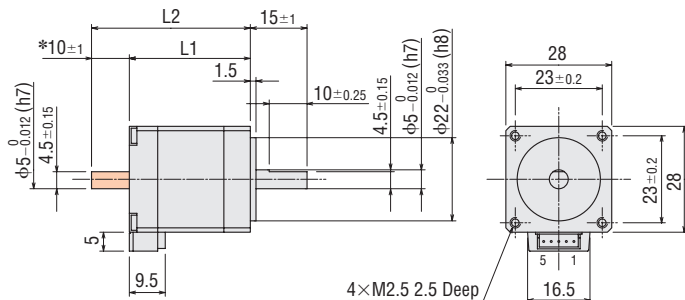

*The length of the shaft flat on the double shaft model is 10±0.25.

● These dimensions are for double shaft motors.

For single shaft motors, ignore the shaded in the areas.

Connection Cable (Sold separately)

Motor Connection Cable

Product Name	Length L [m]
LC5N06A	0.6
LC5N10A	1

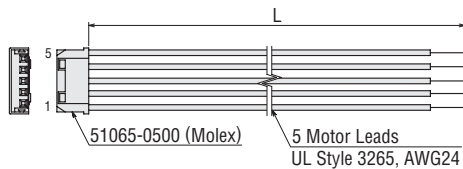

Motor Pin Assignments

Motor Pin Assignments: Model B

- Refer to the motor pin arrangement page for information on motor pin arrangement.

Standard Type Frame Size 42 mm

Mini-Connector Type

Specifications

Product Name		Maximum Holding Torque [Nm]	Rotor Inertia J: kgm ²	Rated Current A/Phase	Winding Resistance Ω/Phase	Basic Step Angle	Recommended Driver Product Name*
Single Shaft	Double Shaft						
PKP543N18A2	PKP543N18B2	0.22	35×10 ⁻⁷	1.8	0.4	0.72°	CVD518BR-K
PKP544N18A2	PKP544N18B2	0.3	55×10 ⁻⁷				
PKP545N18A2	PKP545N18B2	0.37	71×10 ⁻⁷				
PKP546N18A2	PKP546N18B2	0.5	110×10 ⁻⁷				

*See "Drivers for 2-Phase / 5-Phase Motors" page for drivers that can be used in combination.

Note

- Be sure to set the driver current at or below the motor rated current. If the motor rated current is exceeded, the product will be damaged.

Speed – Torque Characteristics (Reference values) f_s : Max. Starting Frequency

PKP543N18A2/PKP543N18B2

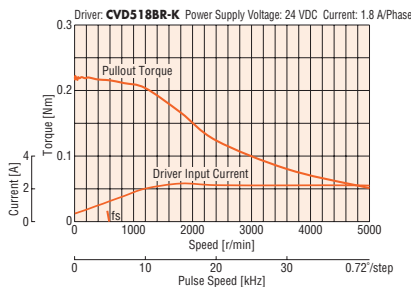

PKP544N18A2/PKP544N18B2

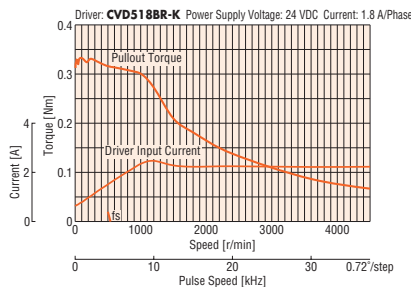

PKP545N18A2/PKP545N18B2

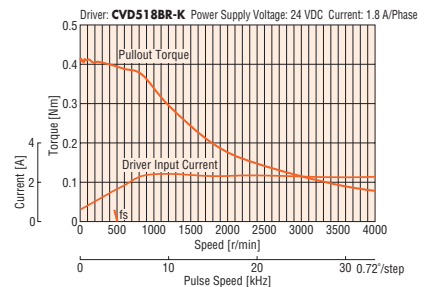

PKP546N18A2/PKP546N18B2

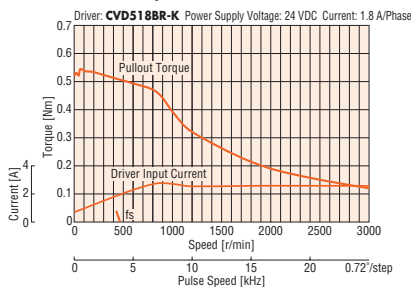

Note

- Data for the speed – torque characteristics is based on Oriental Motor's internal measurement conditions. If the conditions are changed, the characteristics may also change as a result.
- Depending on the driving conditions, a considerable amount of heat may be generated by the motor. Be sure to keep the motor case temperature at 100°C max.
- The characteristics are the same when RS-485 communication type driver is used in combination.

Dimensions (Unit: mm)

Motor

Product Name	L1	L2	Mass [kg]
PKP543N18A2	33	—	0.23
PKP543N18B2	33	48	0.23
PKP544N18A2	39	—	0.29
PKP544N18B2	39	54	0.29
PKP545N18A2	47	—	0.37
PKP545N18B2	47	62	0.37
PKP546N18A2	59	—	0.49
PKP546N18B2	59	74	0.49

Applicable Connectors

Connector Housing: MDF97A-5S-3.5C (HIROSE ELECTRIC CO., LTD)
 Contact: MDF97-22SC (HIROSE ELECTRIC CO., LTD)
 Crimping Tool: HT801/MDF97-22S (HIROSE ELECTRIC CO., LTD)

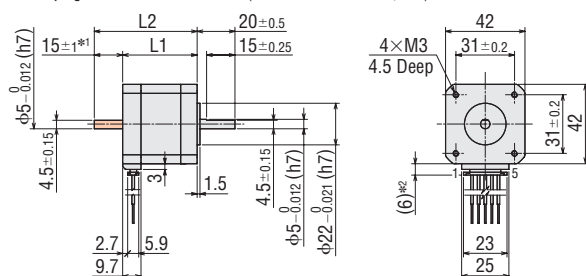

*1 The length of the shaft flat on the double shaft model is 15±0.25.

*2 With connection cable.

● These dimensions are for double shaft motors.

For single shaft motors, ignore the shaded in the [] areas.

Connection Cable (Sold separately)

Motor Connection Cable

Product Name	Length L [m]
LC5N06E	0.6
LC5N10E	1

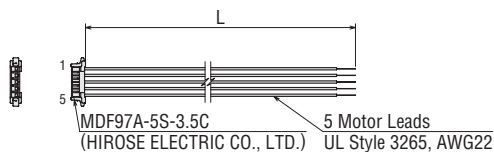

Motor Pin Assignments

Motor Pin Assignments: Model A

- Refer to the motor pin arrangement page for information on motor pin arrangement.

2-Phase Motors
PKP

Features Product Line

Product Number Product Line

Standard Type

High-Resolution Type

Flat Type

SH Geared Type

CS Geared Type

Common Specifications

Inner Wiring of Motor

5-Phase Motors
PKP

Features Product Line

Product Number Product Line

Standard Type

High-Resolution Type

TS Geared Type

Common Specifications

Motor Pin Arrangement

Drivers for 2-Phase/5-Phase Motors

Peripheral Equipment

Standard Type Frame Size 42 mm

Connector Type

Specifications

Product Name		Maximum Holding Torque [Nm]	Rotor Inertia J: kgm ²	Rated Current A/Phase	Winding Resistance Ω/Phase	Basic Step Angle	Recommended Driver Product Name*
Single Shaft	Double Shaft						
PKP544N18A	PKP544N18B	0.26	57×10^{-7}	1.8	0.51	0.72°	CVD518BR-K
PKP546N18A	PKP546N18B	0.44	114×10^{-7}				

*See "Drivers for 2-Phase / 5-Phase Motors" page for drivers that can be used in combination.

Note

- Be sure to set the driver current at or below the motor rated current. If the motor rated current is exceeded, the product will be damaged.

Speed – Torque Characteristics (Reference values) fs: Max. Starting Frequency

PKP544N18A/ PKP544N18B

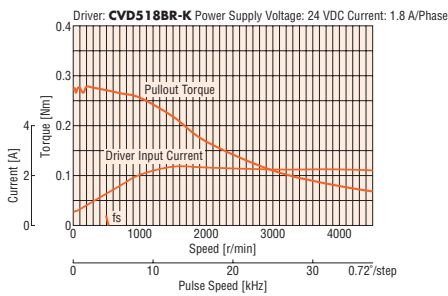

PKP546N18A/ PKP546N18B

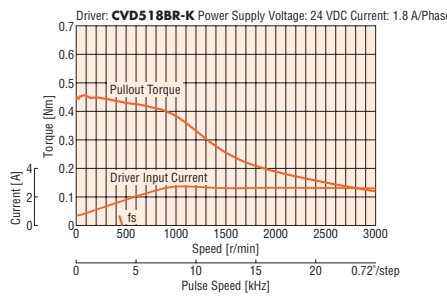

Note

- Data for the speed – torque characteristics is based on Oriental Motor's internal measurement conditions. If the conditions are changed, the characteristics may also change as a result.
- Depending on the driving conditions, a considerable amount of heat may be generated by the motor. Be sure to keep the motor case temperature at 100°C or less.
- The characteristics are the same if combined with an RS-485 communication type driver.

Dimensions (Unit: mm)

● Motor

Product Name	L1	L2	Mass [kg]
PKP544N18A	39	-	0.3
PKP544N18B		54	
PKP546N18A	59	-	0.5
PKP546N18B		74	

● Applicable Connectors

Connector Housing: 51103-0600 (Molex)

Contact: 50351-8100 (Molex)

Crimp Tool: 57295-5000 (Molex)

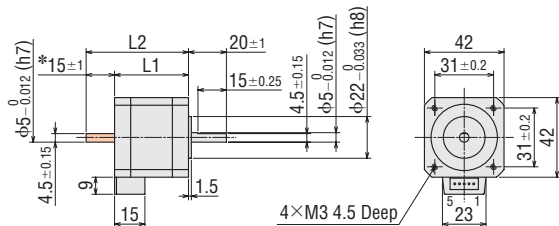

*The length of the shaft flat on the double shaft model is 15±0.25.

● These dimensions are for double shaft motors.

For single shaft motors, ignore the shaded areas.

● Connection Cable (Sold separately)

◇ Motor Connection Cable

Product Name	Length L [m]
LC5N06B	0.6
LC5N10B	1

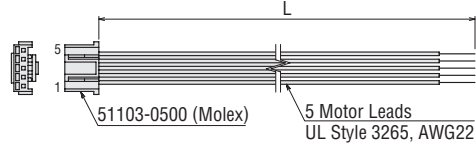

Motor Pin Assignments

Motor Pin Arrangement: Model B

- Refer to the motor pin arrangement page for information on motor pin arrangement.

Standard Type with Encoder Frame Size 42 mm

Mini-Connector Type

Specifications

Product Name	Maximum Holding Torque [Nm]	Rotor Inertia J: kgm ²	Rated Current A/Phase	Winding Resistance Ω/Phase	Basic Step Angle	Recommended Driver Product Name*
PKP543N18A2-R2GL	0.22	35×10 ⁻⁷	1.8	0.4	0.72°	CVD518BR-K
PKP544N18A2-R2GL	0.3	55×10 ⁻⁷		0.48		
PKP545N18A2-R2GL	0.37	71×10 ⁻⁷		0.55		
PKP546N18A2-R2GL	0.5	110×10 ⁻⁷		0.64		

● See "Common Specifications" page for encoder specifications.

*See "Drivers for 2-Phase / 5-Phase Motors" page for drivers that can be used in combination.

Note

● Be sure to set the driver current at or below the motor rated current. If the motor rated current is exceeded, the product will be damaged.

Speed – Torque Characteristics (Reference values) fs: Max. Starting Frequency

PKP543N18A2-R2GL

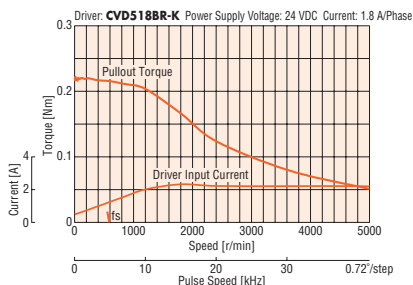

PKP544N18A2-R2GL

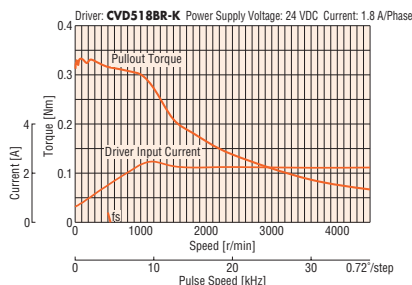

PKP545N18A2-R2GL

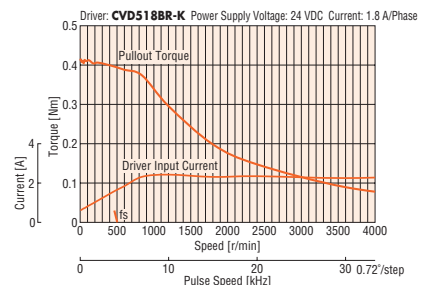

PKP546N18A2-R2GL

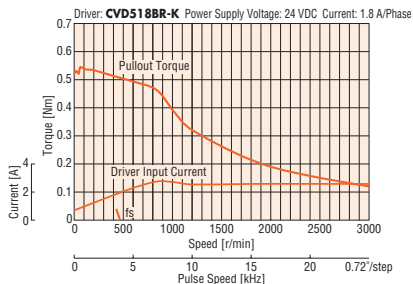

Note

● Data for the speed – torque characteristics is based on Oriental Motor's internal measurement conditions. If the conditions are changed, the characteristics may also change as a result.

● For the type with an encoder, to protect the encoder, be sure to keep the motor case temperature at 85°C max.

● The characteristics are the same when RS-485 communication type driver is used in combination.

Dimensions (Unit: mm)

Motor

Product Name	L	Mass [kg]
PKP543N18A2-R2GL	46.5	0.24
PKP544N18A2-R2GL	52.5	0.3
PKP545N18A2-R2GL	60.5	0.38
PKP546N18A2-R2GL	72.5	0.5

● Applicable Connectors

	Motor (HIROSE ELECTRIC CO.,LTD.)	Encoder (Molex)
Connector Housing	MDF97A-5S-3.5C	51021-0800
Contact	MDF97-22SC	50079-8100
Crimp Tool	HT801/MDF97-22S	57177-5000

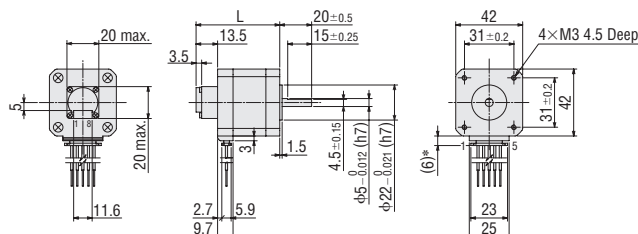

*With connection cable

Motor Pin Assignments

Motor Pin Assignments: Model A

● Refer to the motor pin arrangement page for information on motor pin arrangement.

Connection Cable (Sold separately)

Motor Connection Cable

Product Name	Length L [m]
LC5N06E	0.6
LC5N10E	1

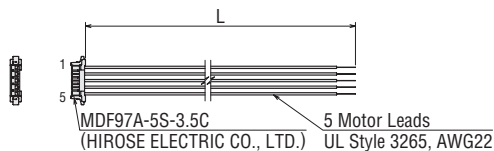

Encoder Connection Cable

Product Name	Length L [m]
LCE08A-006	0.6

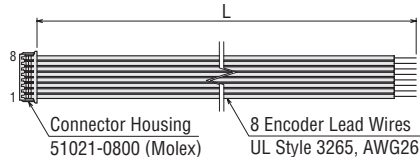

2-Phase Motors
PKP

Features Product Line

Product Number Product Line

Standard Type

High-Resolution Type

Flat Type

SH Geared Type

CS Geared Type

Common Specifications

Inner Wiring of Motor

5-Phase Motors
PKP

Features Product Line

Product Number Product Line

Standard Type

High-Resolution Type

TS Geared Type

Common Specifications

Motor Pin Arrangement

Drivers for 2-Phase/5-Phase Motors

Peripheral Equipment

Standard Type Frame Size 56.4 mm

Mini-Connector Type

13 mm

20 mm

28 mm

35 mm

42 mm

50 mm

51 mm

56.4 mm

60 mm

61 mm

85 mm

90 mm

Specifications

Product Name		Maximum Holding Torque [Nm]	Rotor Inertia J: kgm ²	Rated Current A/Phase	Winding Resistance Ω/Phase	Basic Step Angle	Recommended Driver Product Name*
Single Shaft	Double Shaft						
PKP564N28A2	PKP564N28B2	0.44	140×10 ⁻⁷	2.8	0.16	0.72°	CVD528BR-K
PKP566N28A2	PKP566N28B2	0.81	270×10 ⁻⁷				
PKP568N28A2	PKP568N28B2	1.5	500×10 ⁻⁷				

*See "Drivers for 2-Phase / 5-Phase Motors" page for drivers that can be used in combination.

Note

- Be sure to set the driver current at or below the motor rated current. If the motor rated current is exceeded, the product will be damaged.

Speed – Torque Characteristics (Reference values) fs: Max. Starting Frequency

PKP564N28A2/PKP564N28B2

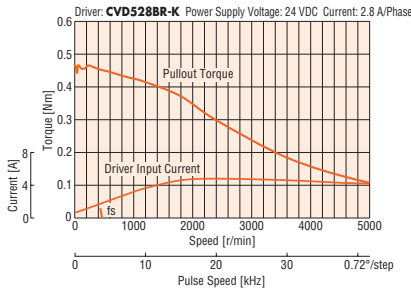

PKP566N28A2/PKP566N28B2

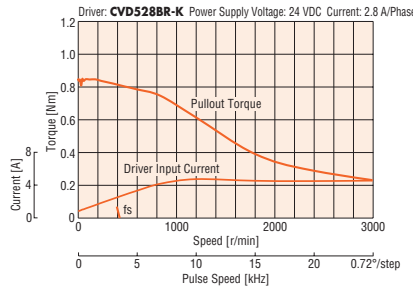

PKP568N28A2/PKP568N28B2

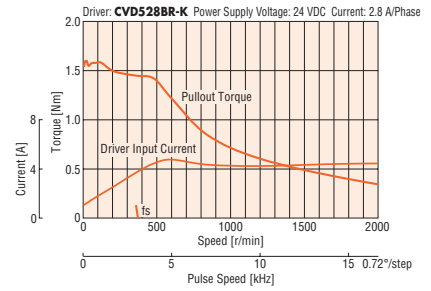

Note

- Data for the speed – torque characteristics is based on Oriental Motor's internal measurement conditions. If the conditions are changed, the characteristics may also change as a result.
- Depending on the driving conditions, a considerable amount of heat may be generated by the motor. Be sure to keep the motor case temperature at 100°C max.
- The characteristics are the same when RS-485 communication type driver is used in combination.

Dimensions (Unit: mm)

● Motor

Product Name	L1	L2	Mass [kg]
PKP564N28A2	39	—	0.43
PKP564N28B2		62	
PKP566N28A2	54	—	0.67
PKP566N28B2		77	
PKP568N28A2	76	—	1
PKP568N28B2		99	

● Applicable Connectors

Connector Housing: MDF97A-5S-3.5C (HIROSE ELECTRIC CO., LTD)
 Contact: MDF97-22SC (HIROSE ELECTRIC CO., LTD)
 Crimping Tool: HT801/MDF97-22S (HIROSE ELECTRIC CO., LTD)

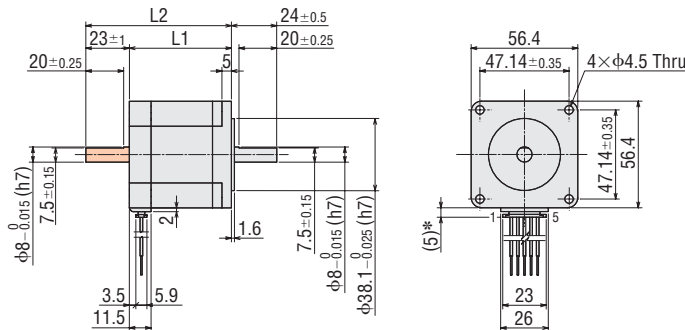

*With connection cable

- These dimensions are for double shaft motors. For single shaft motors, ignore the shaded in the areas.

● Connection Cable (Sold separately)

◇ Motor Connection Cable

Product Name	Length L [m]
LC5N06E	0.6
LC5N10E	1

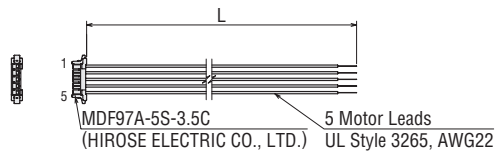

Motor Pin Assignments

Motor Pin Assignments: Model A

- Refer to the motor pin arrangement page for information on motor pin arrangement.

Standard Type with Encoder Frame Size 56.4 mm

Mini-Connector Type

Specifications

Product Name	Maximum Holding Torque [Nm]	Rotor Inertia J: kgm ²	Rated Current A/Phase	Winding Resistance Ω/A	Basic Step Angle	Recommended Driver Product Name*
PKP564N28A2-R2GL	0.44	140×10 ⁻⁷	2.8	0.16	0.72°	CVD528BR-K
PKP566N28A2-R2GL	0.81	270×10 ⁻⁷		0.24		
PKP568N28A2-R2GL	1.5	500×10 ⁻⁷		0.37		

● See "Common Specifications" page for encoder specifications.

*See "Drivers for 2-Phase / 5-Phase Motors" page for drivers that can be used in combination.

Note

● Be sure to set the driver current at or below the motor rated current. If the motor rated current is exceeded, the product will be damaged.

Speed – Torque Characteristics (Reference values) fs: Max. Starting Frequency

PKP564N28A2-R2GL

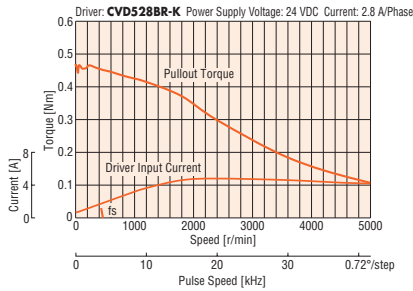

PKP566N28A2-R2GL

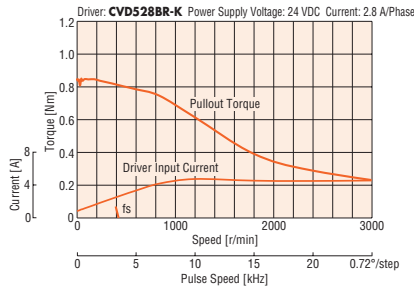

PKP568N28A2-R2GL

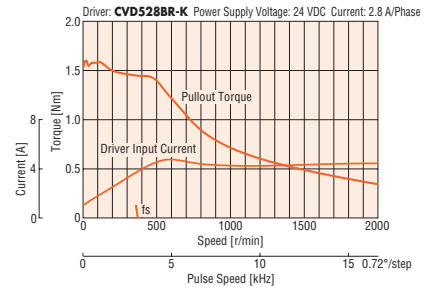

Note

● Data for the speed – torque characteristics is based on Oriental Motor's internal measurement conditions. If the conditions are changed, the characteristics may also change as a result.

● For the type with an encoder, to protect the encoder, be sure to keep the motor case temperature at 85°C max.

● The characteristics are the same when RS-485 communication type driver is used in combination.

Dimensions (Unit: mm)

Motor

Product Name	L	Mass [kg]
PKP564N28A2-R2GL	55.5	0.43
PKP566N28A2-R2GL	70.5	0.67
PKP568N28A2-R2GL	92.5	1

Applicable Connectors

	Motor (HIROSE ELECTRIC CO.,LTD.)	Encoder (Molex)
Connector Housing	MDF97A-5S-3.5C	51021-0800
Contact	MDF97-22SC	50079-8100
Crimp Tool	HT801/MDF97-22S	57177-5000

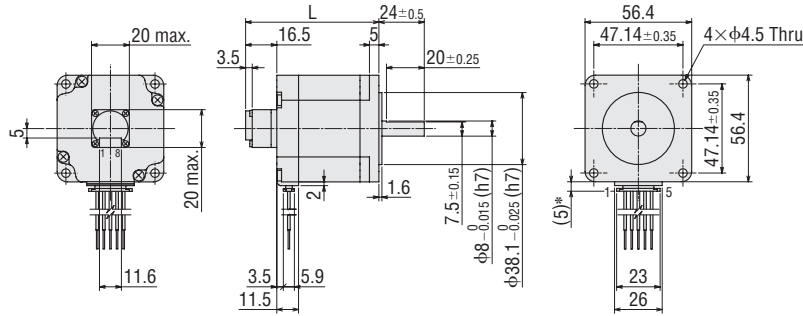

*With connection cable

Connection Cable (Sold separately)

Motor Connection Cable

Product Name	Length L [m]
LC5N06E	0.6
LC5N10E	1

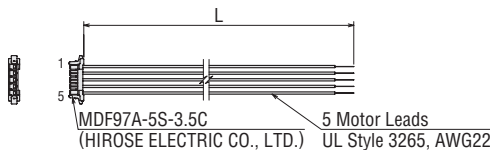

Encoder Connection Cable

Product Name	Length L [m]
LCE08A-006	0.6

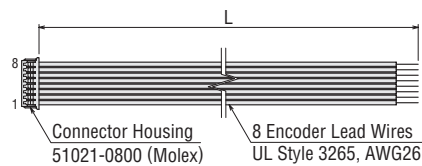

Motor Pin Assignments

Motor Pin Assignments: Model A

● Refer to the motor pin arrangement page for information on motor pin arrangement.

2-Phase Motors
PKP

Features Product Line

Product Number Product Line

Standard Type

High-Resolution Type

Flat Type

SH Geared Type

CS Geared Type

Common Specifications

Inner Wiring of Motor

5-Phase Motors
PKP

Features Product Line

Product Number Product Line

Standard Type

High-Resolution Type

TS Geared Type

Common Specifications

Motor Pin Arrangement

Drivers for 2-Phase/5-Phase Motors

Peripheral Equipment

Standard Type Frame Size 60 mm

Mini-Connector Type

Specifications

Product Name		Maximum Holding Torque [Nm]	Rotor Inertia J: kgm ²	Rated Current A/Phase	Winding Resistance Ω/Phase	Basic Step Angle	Recommended Driver Product Name*
Single Shaft	Double Shaft						
PKP564FN24A2	PKP564FN24B2	0.66	160×10 ⁻⁷	2.4	0.28	0.72°	CVD524BR-K
PKP564FN38A2	PKP564FN38B2			3.8	0.12		CVD538BR-K
PKP566FN24A2	PKP566FN24B2	1.15	290×10 ⁻⁷	2.4	0.38		CVD524BR-K
PKP566FN38A2	PKP566FN38B2			3.8	0.16		CVD538BR-K
PKP569FN24A2	PKP569FN24B2	2.1	540×10 ⁻⁷	2.4	0.64		CVD524BR-K
PKP569FN38A2	PKP569FN38B2			3.8	0.22		CVD538BR-K

*See "Drivers for 2-Phase / 5-Phase Motors" page for drivers that can be used in combination.

Note

- Be sure to set the driver current at or below the motor rated current. If the motor rated current is exceeded, the product will be damaged.

Speed – Torque Characteristics (Reference values) fs: Max. Starting Frequency

PKP564FN24A2/ PKP564FN24B2

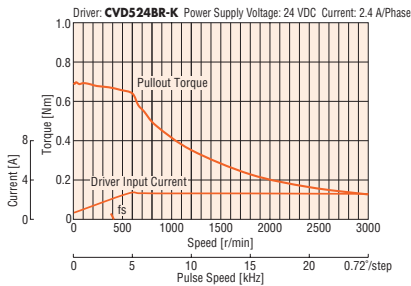

PKP566FN24A2/ PKP566FN24B2

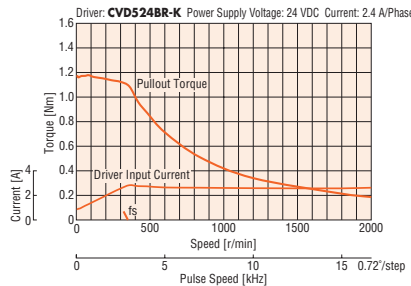

PKP569FN24A2/ PKP569FN24B2

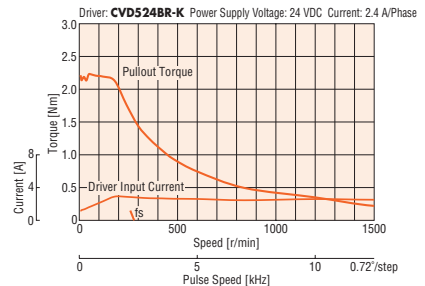

PKP564FN38A2/ PKP564FN38B2

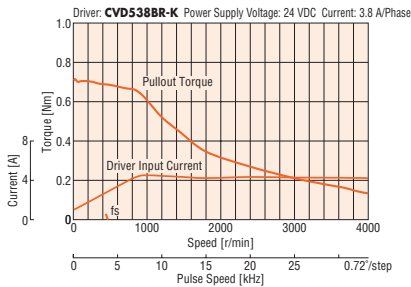

PKP566FN38A2/ PKP566FN38B2

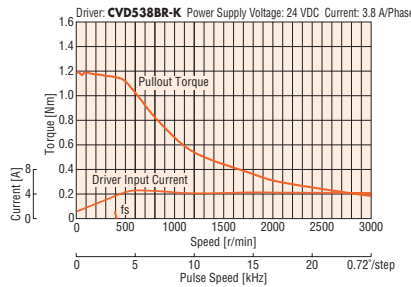

PKP569FN38A2/ PKP569FN38B2

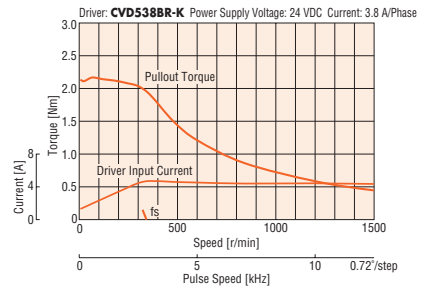

Note

- Data for the speed – torque characteristics is based on Oriental Motor's internal measurement conditions. If the conditions are changed, the characteristics may also change as a result.
- Depending on the driving conditions, a considerable amount of heat may be generated by the motor. Be sure to keep the motor case temperature at 100°C max.
- The characteristics are the same when RS-485 communication type driver is used in combination.

Dimensions (Unit: mm)

● Motor

Product Name	L1	L2	Mass [kg]
PKP564FN24A2	44	—	0.56
PKP564FN24B2		65	
PKP564FN38A2		—	
PKP564FN38B2		65	
PKP566FN24A2	56	—	0.79
PKP566FN24B2		77	
PKP566FN38A2		—	
PKP566FN38B2		77	
PKP569FN24A2	84.5	—	1.3
PKP569FN24B2		105.5	
PKP569FN38A2		—	
PKP569FN38B2		105.5	

● Applicable Connectors

Connector Housing: MDF97A-5S-3.5C (HIROSE ELECTRIC CO., LTD)
 Contact: MDF97-22SC (HIROSE ELECTRIC CO., LTD)
 Crimping Tool: HT801/MDF97-22S (HIROSE ELECTRIC CO., LTD)

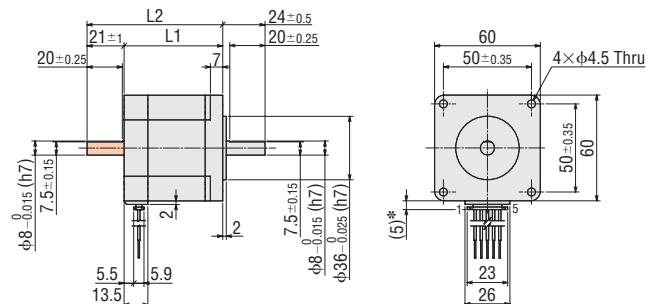

*With connection cable

● These dimensions are for double shaft motors.

For single shaft motors, ignore the shaded in the areas.

● Connection Cable (Sold separately)

◇ Motor Connection Cable

Product Name	Length L [m]
LC5N06E	0.6
LC5N10E	1

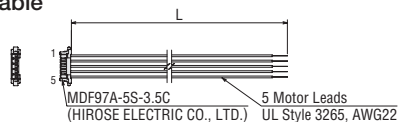

Motor Pin Assignments

Motor Pin Assignments: Model A

- Refer to the motor pin arrangement page for information on motor pin arrangement.

Standard Type with Encoder Frame Size 60 mm

Mini-Connector Type

Specifications

Product Name	Maximum Holding Torque [Nm]	Rotor Inertia J: kgm ²	Rated Current A/Phase	Winding Resistance Ω/Phase	Basic Step Angle	Recommended Driver Product Name*
PKP564FN24A2-R2GL	0.66	160×10 ⁻⁷	2.4	0.28	72°	CVD524BR-K
PKP564FN38A2-R2GL			3.8	0.12		CVD538BR-K
PKP566FN24A2-R2GL	1.15	290×10 ⁻⁷	2.4	0.38		CVD524BR-K
PKP566FN38A2-R2GL			3.8	0.16		CVD538BR-K
PKP569FN24A2-R2GL	2.1	540×10 ⁻⁷	2.4	0.64		CVD524BR-K
PKP569FN38A2-R2GL			3.8	0.22		CVD538BR-K

● See "Common Specifications" page for encoder specifications.

*See "Drivers for 2-Phase / 5-Phase Motors" page for drivers that can be used in combination.

Note

● Be sure to set the driver current at or below the motor rated current. If the motor rated current is exceeded, the product will be damaged.

Speed – Torque Characteristics (Reference values) fs: Max. Starting Frequency

PKP564FN24A2-R2GL

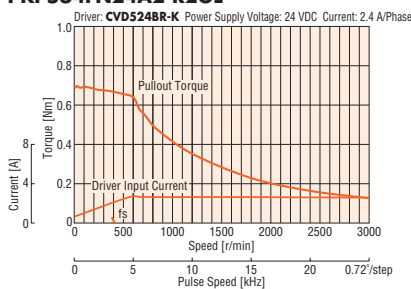

PKP566FN24A2-R2GL

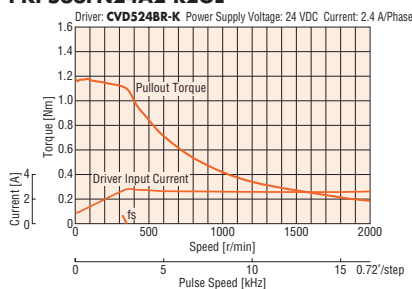

PKP569FN24A2-R2GL

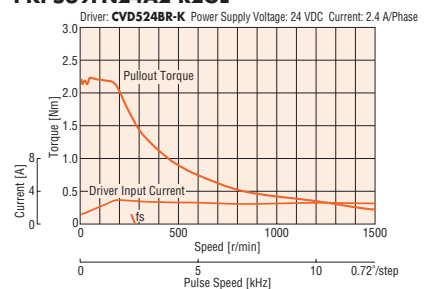

PKP564FN38A2-R2GL

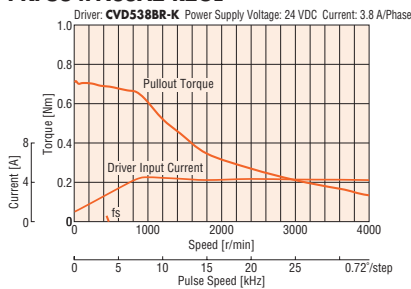

PKP566FN38A2-R2GL

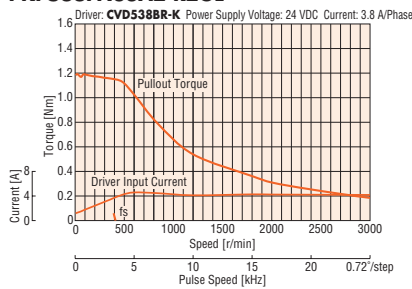

PKP569FN38A2-R2GL

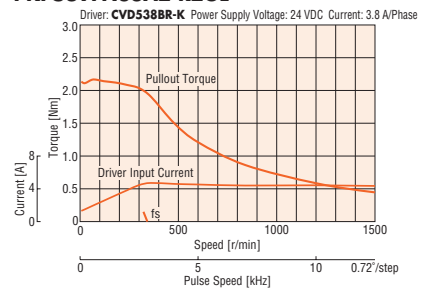

Note

● Data for the speed – torque characteristics is based on Oriental Motor's internal measurement conditions. If the conditions are changed, the characteristics may also change as a result.

● For the type with an encoder, to protect the encoder, be sure to keep the motor case temperature at 85°C max.

● The characteristics are the same when RS-485 communication type driver is used in combination.

Dimensions (Unit: mm)

Motor

Product Name	L	Mass [kg]
PKP564FN24A2-R2GL	60.5	0.56
PKP564FN38A2-R2GL		
PKP566FN24A2-R2GL	72.5	0.79
PKP566FN38A2-R2GL		
PKP569FN24A2-R2GL	101	1.3
PKP569FN38A2-R2GL		

● Applicable Connectors

	Motor (HIROSE ELECTRIC CO.,LTD.)	Encoder (Molex)
Connector Housing	MDF97A-5S-3.5C	51021-0800
Contact	MDF97-22SC	50079-8100
Crimp Tool	HT801/MDF97-22S	57177-5000

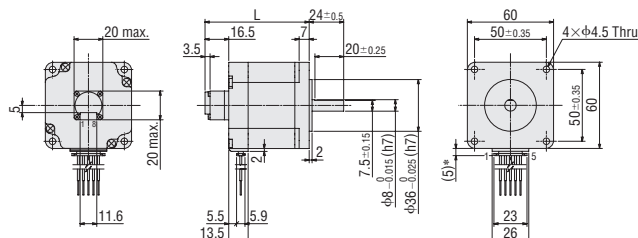

*With connection cable

Connection Cable (Sold separately)

Motor Connection Cable

Product Name	Length L [m]
LC5N06E	0.6
LC5N10E	1

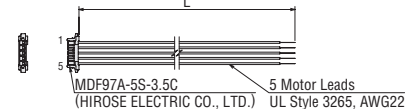

Encoder Connection Cable

Product Name	Length L [m]
LCE08A-006	0.6

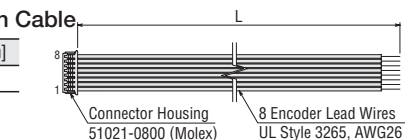

Motor Pin Assignments

Motor Pin Assignments: Model A

● Refer to the motor pin arrangement page for information on motor pin arrangement.

2-Phase Motors PKP

Features Product Line

Product Number Product Line

Standard Type

High-Resolution Type

Flat Type

SH Geared Type

CS Geared Type

Common Specifications

Inner Wiring of Motor

5-Phase Motors PKP

Features Product Line

Product Number Product Line

Standard Type

High-Resolution Type

TS Geared Type

Common Specifications

Motor Pin Arrangement

Drivers for 2-Phase/5-Phase Motors

Peripheral Equipment

Standard Type Frame Size 85 mm

Lead Wire Type

13 mm

20 mm

28 mm

35 mm

42 mm

50 mm

51 mm

56.4 mm

60 mm

61 mm

85 mm

90 mm

Specifications

Product Name		Maximum Holding Torque [Nm]	Rotor Inertia J: kgm ²	Rated Current A/Phase	Winding Resistance Ω/Phase	Basic Step Angle	Recommended Driver Product Name*
Single Shaft	Double Shaft						
PK596HNAW	PK596HNBW	2.1	1400×10 ⁻⁷	2.8	0.41	0.72°	CVD528BR-K
PK599HNAW	PK599HNBW	4.1	2700×10 ⁻⁷		0.46		
PK5913HNAW	PK5913HNBW	6.3	4000×10 ⁻⁷		0.72		

*See "Drivers for 2-Phase / 5-Phase Motors" page for drivers that can be used in combination.

Note

- Be sure to set the driver current at or below the motor rated current. If the motor rated current is exceeded, the product will be damaged.

Speed – Torque Characteristics (Reference values) fs: Max. Starting Frequency

PK596HNAW/PK596HNBW

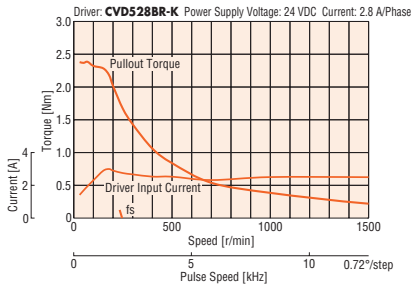

PK599HNAW/PK599HNBW

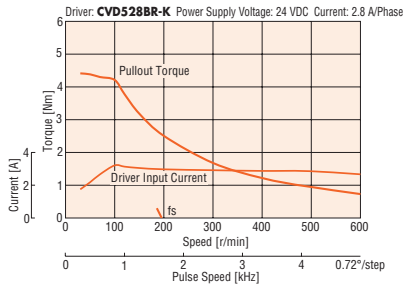

PK5913HNAW/PK5913HNBW

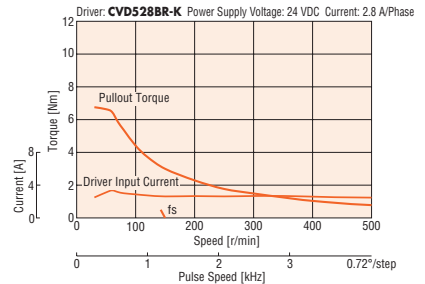

Note

- Data for the speed – torque characteristics is based on Oriental Motor's internal measurement conditions. If the conditions are changed, the characteristics may also change as a result.
- Depending on the driving conditions, a considerable amount of heat may be generated by the motor. Be sure to keep the motor case temperature at 100°C max.

Dimensions (Unit: mm)

Motor

Product Name	L1	L2	Mass [kg]
PK596HNAW	66	—	1.7
PK596HNBW		100	
PK599HNAW	96	—	2.8
PK599HNBW		130	
PK5913HNAW	126	—	3.8
PK5913HNBW		160	

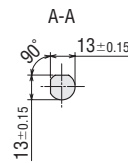
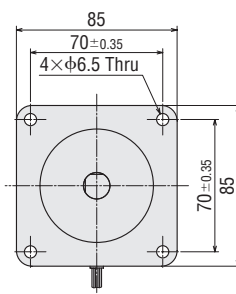
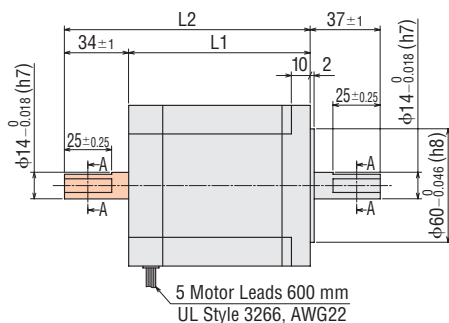

- These dimensions are for double shaft motors. For single shaft motors, ignore the shaded in the [shaded area] areas.

Motor Pin Assignments

Motor Pin Assignments: Model C

- Refer to the motor pin arrangement page for information on motor pin arrangement.

High-Resolution Type Frame Size 42 mm

Connector Type

Specifications

Product Name		Maximum Holding Torque [Nm]	Rotor Inertia J: kgm ²	Rated Current A/Phase	Winding Resistance Ω/Phase	Basic Step Angle	Recommended Driver Product Name*
Single Shaft	Double Shaft						
PKP544MN18A	PKP544MN18B	0.26	60×10 ⁻⁷	1.8	0.51	0.36°	CVD518BR-K
PKP546MN18A	PKP546MN18B	0.44	121×10 ⁻⁷		0.66		

*See "Drivers for 2-Phase / 5-Phase Motors" page for drivers that can be used in combination.

Note

- Be sure to set the driver current at or below the motor rated current. If the motor rated current is exceeded, the product will be damaged.

Speed – Torque Characteristics (Reference values) fs: Max. Starting Frequency

PKP544MN18A/PKP544MN18B

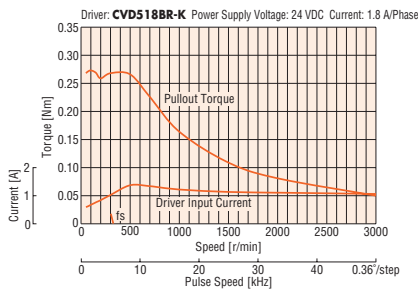

PKP546MN18A/PKP546MN18B

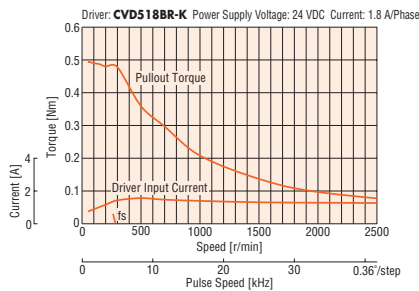

Note

- Data for the speed – torque characteristics is based on Oriental Motor's internal measurement conditions. If the conditions are changed, the characteristics may also change as a result.
- Depending on the driving conditions, a considerable amount of heat may be generated by the motor. Be sure to keep the motor case temperature at 100°C max.
- The characteristics are the same when RS-485 communication type driver is used in combination.

Dimensions (Unit: mm)

Motor

Product Name	L1	L2	Mass [kg]
PKP544MN18A	39	—	0.3
PKP544MN18B		54	
PKP546MN18A	59	—	0.5
PKP546MN18B		74	

Applicable Connectors

Connector Housing: 51103-0500 (Molex)
Contact: 50351-8100 (Molex)
Crimp Tool: 57295-5000 (Molex)

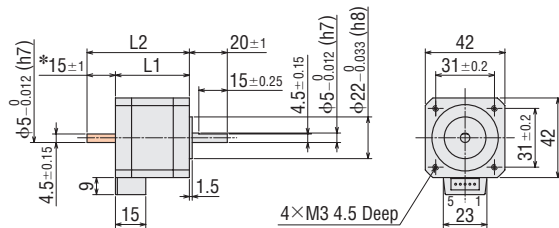

*The length of the shaft flat on the double shaft model is 15±0.25.

● These dimensions are for double shaft motors.

For single shaft motors, ignore the shaded in the areas.

Connection Cable (Sold separately)

Motor Connection Cable

Product Name	Length L [m]
LC5N06B	0.6
LC5N10B	1

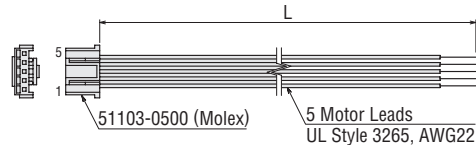

Motor Pin Assignments

Motor Pin Assignments: Model B

- Refer to the motor pin arrangement page for information on motor pin arrangement.

2-Phase Motors
PKP

Features Product Line

Product Number Product Line

Standard Type

High-Resolution Type

Flat Type

SH Gearing Type

CS Gearing Type

Common Specifications

Inner Wiring of Motor

5-Phase Motors
PKP

Features Product Line

Product Number Product Line

Standard Type

High-Resolution Type

TS Gearing Type

Common Specifications

Motor Pin Arrangement

Drivers for 2-Phase/5-Phase Motors

Peripheral Equipment

High-Resolution Type Frame Size 60 mm

Connector Type

13 mm

20 mm

28 mm

35 mm

42 mm

50 mm

51 mm

56.4 mm

60 mm

61 mm

85 mm

90 mm

Specifications

Product Name		Maximum Holding Torque [Nm]	Rotor Inertia J: kgm ²	Rated Current A/Phase	Winding Resistance Ω/Phase	Basic Step Angle	Recommended Driver Product Name*
Single Shaft	Double Shaft						
PKP564FMN24A	PKP564FMN24B	0.78	310×10^{-7}	2.4	0.32	0.36°	CVD524BR-K
PKP566FMN24A	PKP566FMN24B	1.25	490×10^{-7}				
PKP569FMN24A	PKP569FMN24B	2.3	970×10^{-7}				

*See "Drivers for 2-Phase / 5-Phase Motors" page for drivers that can be used in combination.

Note

- Be sure to set the driver current at or below the motor rated current. If the motor rated current is exceeded, the product will be damaged.

Speed – Torque Characteristics (Reference values) fs: Max. Starting Frequency

PKP564FMN24A/ PKP564FMN24B

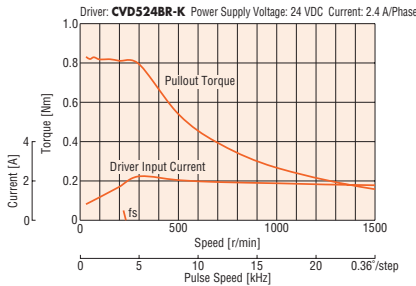

PKP566FMN24A/ PKP566FMN24B

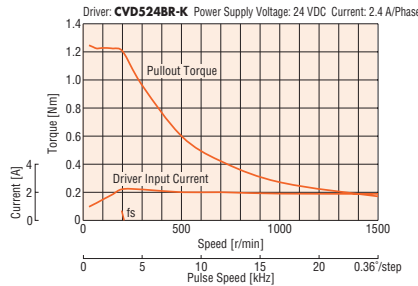

PKP569FMN24A/ PKP569FMN24B

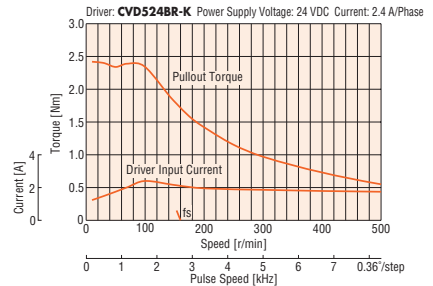

Note

- Data for the speed – torque characteristics is based on Oriental Motor's internal measurement conditions. If the conditions are changed, the characteristics may also change as a result.
- Depending on the driving conditions, a considerable amount of heat may be generated by the motor. Be sure to keep the motor case temperature at 100°C max.
- The characteristics are the same when RS-485 communication type driver is used in combination.

Dimensions (Unit: mm)

Motor

Product Name	L1	L2	L3	φD	Mass [kg]
PKP564FMN24A	46.5	—	7.5±0.15	8 ⁰ _{-0.015}	0.65
PKP564FMN24B		69.5			
PKP566FMN24A	56	—	9.5±0.15	10 ⁰ _{-0.015}	0.87
PKP566FMN24B		79			
PKP569FMN24A	87	—	110	—	1.5
PKP569FMN24B		110			

Applicable Connectors

Connector Housing: VHR-5N (J.S.T.MFG.CO.,LTD.)

Contact: BVH-21T-P1.1 (J.S.T.MFG.CO.,LTD.)

Crimp Tool: YC-160R (J.S.T.MFG.CO.,LTD.)

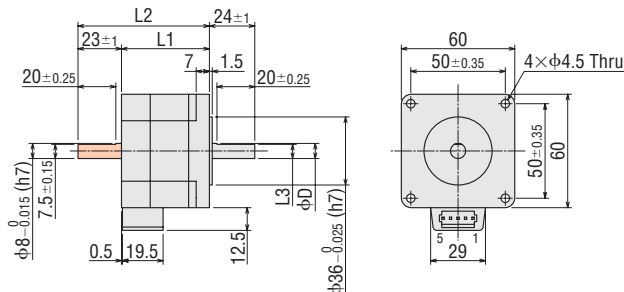

- These dimensions are for double shaft motors. For single shaft motors, ignore the shaded in the areas.

Connection Cable (Sold separately)

◇ Motor Connection Cable

Product Name	Length L [m]
LC5N06C2	0.6
LC5N10C2	1

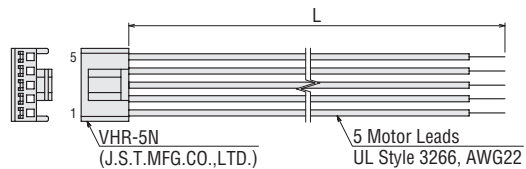

Motor Pin Assignments

Motor Pin Assignments: Model B

- Refer to the motor pin arrangement page for information on motor pin arrangement.

General Specifications

Specifications		Motor
Thermal Class		130(B)
Insulation Resistance		100 MΩ or more when 500 VDC megger is applied between the windings and the case under normal ambient temperature and humidity.
Dielectric Strength		No abnormalities are observed, even when applying voltage between the windings and the case for 1 minute under normal ambient temperature and humidity with the following conditions. • PK513 , PKP52 □, and PKP54 □: 0.5 kVAC, 50/60 Hz • PKP56 □: 1.0 kVAC, 50/60 Hz • PKP56 □ FMN , and PK59 □: 1.5 kVAC, 50/60 Hz
Operating Environment	Ambient Temperature	-10 to +50°C (non-freezing)
	Ambient Humidity	85% or less (Non-Condensing)
	Surrounding Atmosphere	No corrosive gas or dust. No water or oil.
Temperature Rise		Winding part temperature rise 80°C max. (Based on Oriental Motor's measurement conditions)
Stop Position Accuracy*1		Standard Type: ±3 arcmin (±0.05°) [PK513 : ±10 arcmin (±0.17°)] High-Resolution Type: ±2 arcmin (±0.034°)
Shaft Runout		0.05 mm T.I.R.*4
Radial Play*2		0.025 mm Max. (Load 5 N)
Axial Play*3		0.075 mm Max. (Load 10 N) [PK513 : Load 1 N, PKP52 □: Load 2.5 N]
Concentricity of Installing Pilot to the Shaft		0.075 mm T.I.R.*4
Perpendicularity of Installation Surface to the Shaft		0.075 mm T.I.R.*4

*1 This value is for full step under no load. (The value changes with the size of the load.)

*2 Radial Play: Displacement in shaft position in the radial direction when a 5 N load is applied in the vertical direction to the tip of the motor shaft.

*3 Axial Play: Displacement in shaft position in the axial direction when a 10 N (**PK513** is 1 N, **PKP52**□ is 2.5 N) load is applied to the motor shaft in the axial direction.

*4 T.I.R. (Total Indicator Reading): The total dial gauge reading when the measurement section is rotated one revolution centered on the reference axis center.

Note

- Do not measure the insulation resistance or perform a dielectric strength test while the motor and driver are connected. And, do not conduct these tests on the motor encoder section.

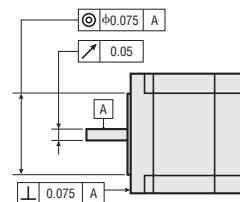

Encoder Specifications

Product Name	R2GL
Resolution	500 P/R
Output Circuit Type	Line Driver*
Output Mode	Incremental
Output Signal	A Phase, B Phase, Z Phase (3ch)
Power Supply Voltage	5 VDC ± 10%
Current	30 mA max.

- A voltage output type of encoder output circuit is also available. For details, please contact your nearest Oriental Motor sales office.
- *26C31 or equivalent

Motor Pin Assignments

Model of Motor	Pin Assignment/Lead Wire Color													
Model A Mini-Connector Type	Pin No. → 5 1	<table border="1"> <thead> <tr> <th>Pin No.</th> <th>Lead Wire Color*</th> </tr> </thead> <tbody> <tr> <td>5</td> <td>Blue</td> </tr> <tr> <td>4</td> <td>Red</td> </tr> <tr> <td>3</td> <td>Orange</td> </tr> <tr> <td>2</td> <td>Green</td> </tr> <tr> <td>1</td> <td>Black</td> </tr> </tbody> </table>	Pin No.	Lead Wire Color*	5	Blue	4	Red	3	Orange	2	Green	1	Black
	Pin No.	Lead Wire Color*												
5	Blue													
4	Red													
3	Orange													
2	Green													
1	Black													
*The colors of lead wires show arrangement of colors of the connection cable sold separately.														
Model B Connector Type	Pin No. → 1 5	<table border="1"> <thead> <tr> <th>Pin No.</th> <th>Lead Wire Color*</th> </tr> </thead> <tbody> <tr> <td>1</td> <td>Blue</td> </tr> <tr> <td>2</td> <td>Red</td> </tr> <tr> <td>3</td> <td>Orange</td> </tr> <tr> <td>4</td> <td>Green</td> </tr> <tr> <td>5</td> <td>Black</td> </tr> </tbody> </table>	Pin No.	Lead Wire Color*	1	Blue	2	Red	3	Orange	4	Green	5	Black
	Pin No.	Lead Wire Color*												
1	Blue													
2	Red													
3	Orange													
4	Green													
5	Black													
*The colors of lead wires show arrangement of colors of the connection cable sold separately.														
Model C Lead Wire Type		<table border="1"> <thead> <tr> <th>Lead Wire Color</th> </tr> </thead> <tbody> <tr> <td>Blue</td> </tr> <tr> <td>Red</td> </tr> <tr> <td>Orange</td> </tr> <tr> <td>Green</td> </tr> <tr> <td>Black</td> </tr> </tbody> </table>	Lead Wire Color	Blue	Red	Orange	Green	Black						
	Lead Wire Color													
Blue														
Red														
Orange														
Green														
Black														
*The colors of lead wires show arrangement of colors of the connection cable sold separately.														

2-Phase
Motors
PKP

Features
Product
Line

Product
Number
Product Line

Standard
Type

High-
Resolution
Type

Flat
Type

SH Geared
Type

CS Geared
Type

Common
Specifications

Inner
Wiring
of Motor

5-Phase
Motors
PKP

Features
Product
Line

Product
Number
Product Line

Standard
Type

High-
Resolution
Type

TS Geared
Type

Common
Specifications

Motor
Pin
Arrangement

Drivers for
2-Phase/5-Phase
Motors

Peripheral
Equipment

Common Specifications

Permissible Radial Load and Permissible Axial Load

Unit: N

Type	Motor Frame Size	Product Name	Gear Ratio	Permissible Radial Load					Permissible Axial Load
				Distance from the Tip of Motor Output Shaft [mm]					
				0	5	10	15	20	
Standard Type	20 mm	PK513	—	12	15	—	—	—	3
	28 mm	PKP523, PKP525	—	25	34	52	—	—	5
	42 mm	PKP543, PKP544□2, PKP545, PKP546□2	—	35	44	58	85	—	15
	42 mm	PKP544, PKP546	—	20	25	34	52	—	10
	56.4 mm	PKP564, PKP566, PKP568	—	90	100	130	180	270	30
	60 mm	PKP564, PKP566, PKP569	—	90	100	130	180	270	30
High-Resolution Type	85 mm	PK596, PK599, PK5913	—	260	290	340	390	480	60
	42 mm	PKP544, PKP546	—	20	25	34	52	—	10
	60 mm	PKP564, PKP566, PKP569	—	90	100	130	180	270	20

Radial Load and Axial Load

Distance from Shaft End [mm]

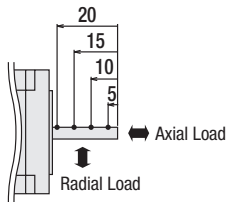

- Motor Frame Size
- 13 mm
 - 20 mm
 - 28 mm
 - 35 mm
 - 42 mm
 - 50 mm
 - 51 mm
 - 56.4 mm
 - 60 mm
 - 61 mm
 - 85 mm
 - 90 mm

2-Phase
Motors
PKP

Features
Product
Line

Product
Number
Product Line

Standard
Type

High-
Resolution
Type

Flat
Type

SH Geared
Type

CS Geared
Type

Common
Specifications

Inner
Wiring
of Motor

5-Phase
Motors
PKP

Features
Product
Line

Product
Number
Product Line

Standard
Type

High-
Resolution
Type

TS Geared
Type

Common
Specifications

Motor
Pin
Arrangement

Drivers for
2-Phase/5-Phase
Motors

Peripheral
Equipment

CVD Series 5-Phase Driver for 2-Phase Stepper Motors

Unipolar Driver for 2-Phase Stepper Motors



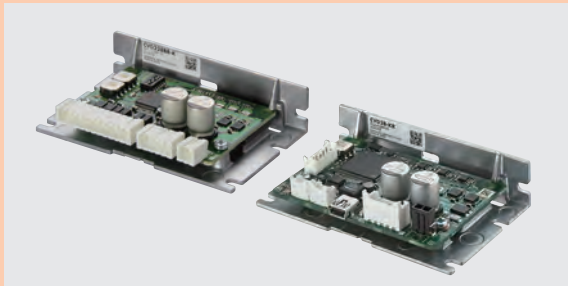



- 2-Phase Bipolar
5-Phase
Pulse Input
- 2-Phase Bipolar
5-Phase
RS-485 Communication
- Cables

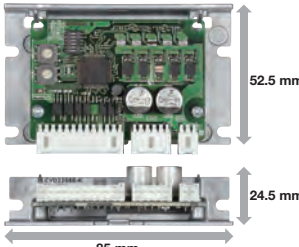

These are DC power supply input drivers for stepper motors. The bipolar/unipolar driver for 2-phase stepper motors and the driver for 5-phase stepper motors are available. Using the microstep drive function for a low-vibration driver reduces vibration and noise.

Features and Types

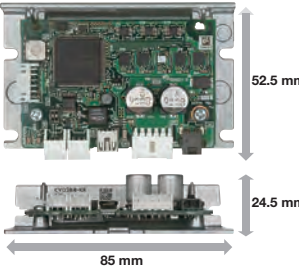
- Bipolar Driver for 2-Phase Stepper Motor
Driver for 5-Phase Stepper Motor
CVD Series

Driver Type	External View	Overview	Driver Installation Direction
<ul style="list-style-type: none"> ● CVD Series Pulse Input Type  <ul style="list-style-type: none"> • Mass 20 g to 70 g (The value differs according to the driver type) 	<p>Right Angle with Installation Plate</p>  <p>With Installation Plate</p>  <p>Without Installation Plate</p> 	<p>The connector points outward.</p> <p>The connector points upward.</p> <p>The connector points upward.</p> <ul style="list-style-type: none"> • Can be controlled depending on the positioning module (pulse generator) • Running current can be easily set with the digital switch 	<ul style="list-style-type: none"> • Horizontal Installation • Vertical Installation
<ul style="list-style-type: none"> ● CVD Series RS-485 Communication Type  <ul style="list-style-type: none"> • Mass 65 g 	<p>Right Angle with Installation Plate</p>  <p>With Installation Plate</p> 	<p>The connector points outward.</p> <p>The connector points upward.</p> <ul style="list-style-type: none"> • Compatible with RS-485 communication (Modbus Protocol) • Easy overwriting of data and multi-axis settings • Reduced wiring of equipment and remote monitoring by host system possible • Compatible with MEXE02 support software 	

Note

● The driver cannot be shared by both a 2-phase stepper motor and 5-phase stepper motor. Each must use its respective dedicated driver.

- For 2-Phase/5-Phase Stepper Motors
Bipolar Driver
CVD Series S Type

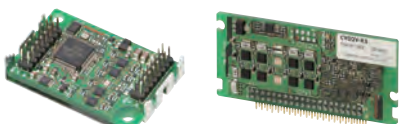

• SPI Communication-Compatible • Pulse Input-Compatible
This is a compact board driver. For details, please contact your nearest Oriental Motor sales office.

- For 5-Phase Stepper Motors
Driver
CVD Series SC Type



This driver can easily control speed by sensing the speed control motor. For details, please contact your nearest Oriental Motor sales office.

Bipolar Driver for 2-Phase Stepper Motors
 Driver for 5-Phase Stepper Motors
CVD Series Pulse Input Type

Product Number

CVD 2 23 F B R - K

- ① ② ③ ④ ⑤ ⑥ ⑦

①	Series Name	CVD: CVD Series
②		2: 2-Phase 5: 5-Phase
③	Rated Current	
④	Driver Identification	
⑤	Driver Shape	B: With Installation Plate Blank: Without Installation Plate
⑥	Connector Shape	R: Right Angle
⑦	Power Supply Input	K: DC Power Supply

Product Line

We have prepared a connection cable set (sold separately) consisting of motor, power supply, and I/O signal cables. The connectors are already crimped, which makes them easy to wire without crimp tools. For details, refer to page 142.

● Bipolar Driver for 2-Phase Stepper Motors

◇ Right Angle Type with Installation Plate

Product Name
CVD205BR-K
CVD206BR-K
CVD215BR-K
CVD223BR-K
CVD223FBR-K
CVD228BR-K
CVD242BR-K
CVD245BR-K

◇ With Installation Plate

Product Name
CVD205B-K
CVD206B-K
CVD215B-K
CVD223B-K
CVD223FB-K
CVD228B-K
CVD242B-K
CVD245B-K

◇ Without Installation Plate

Product Name
CVD205-K
CVD206-K
CVD215-K
CVD223-K
CVD223F-K
CVD228-K

● Driver for 5-Phase Stepper Motors

◇ Right Angle Type with Installation Plate

Product Name
CVD503BR-K
CVD507BR-K
CVD512BR-K
CVD514BR-K
CVD518BR-K
CVD524BR-K
CVD528BR-K
CVD538BR-K

◇ With Installation Plate

Product Name
CVD503B-K
CVD507B-K
CVD512B-K
CVD514B-K
CVD518B-K
CVD524B-K
CVD528B-K
CVD538B-K

◇ Without Installation Plate

Product Name
CVD503-K
CVD507-K
CVD512-K
CVD514-K
CVD518-K
CVD524-K

Included

Type	Connector for Driver Connection
Common to All Types	CN1 Connector (1 pc.), CN2 Connector (1 pc.), CN3 Connector (1 pc.)

2-Phase
Motors
PKP

Features
Product
Line

Product
Number
Product Line

Standard
Type

High-
Resolution
Type

Flat
Type

SH Geared
Type

CS Geared
Type

Common
Specifications

Inner
Wiring
of Motor

5-Phase
Motors
PKP

Features
Product
Line

Product
Number
Product Line

Standard
Type

High-
Resolution
Type

T5 Geared
Type

Common
Specifications

Motor
Pin
Arrangement

Drivers for
2-Phase/5-Phase
Motors

Peripheral
Equipment

Specifications

● Bipolar Driver for 2-Phase Stepper Motors



Product Name	CVD205□□-K	CVD206□□-K	CVD215□□-K	CVD223□□-K CVD223F□□-K	CVD228□□-K	CVD242B□-K	CVD245B□-K
Driving Method	Microstep Drive, Bipolar, Constant Current Drive Method						
Motor Driving Current (Factory Setting)	0.5 A/Phase	0.6 A/Phase	1.5 A/Phase	2.3 A/Phase	2.8 A/Phase	4.2 A/Phase	4.5 A/Phase
Power Supply Voltage	24 VDC ± 10%						
Input Current A	0.5	0.5	1.9	2.0	3.0	3.6	3.9
Max. Input Pulse Frequency	Line driver output by programmable controller: 1 MHz (When the pulse duty is 50%) Open-collector output by programmable controller: 250 kHz (When the pulse duty is 50%) Negative Logic Pulse Input						
Operating Environment	Ambient Temperature	0 to +50°C (Non-freezing)					
	Ambient Humidity	85% or less (Non-condensing)					
	Surrounding Atmosphere	No corrosive gas or dust. No water or oil.					

● Driver for 5-Phase Stepper Motors



Product Name	CVD503□□-K	CVD507□□-K	CVD512□□-K	CVD514□□-K	CVD518□□-K	CVD524B□-K	CVD528B□-K	CVD538B□-K
Driving Method	Microstep Drive, Bipolar, Constant Current Drive Method							
Motor Driving Current (Factory Setting)	0.35 A/Phase	0.75 A/Phase	1.2 A/Phase	1.4 A/Phase	1.8 A/Phase	2.4 A/Phase	2.8 A/Phase	3.8 A/Phase
Power Supply Voltage	24 VDC ± 10%							
Input Current A	0.6	1.4	1.7	1.8	2.8	3.0	4.8	4.8
Max. Input Pulse Frequency	Line driver output by programmable controller: 1 MHz (When the pulse duty is 50%) Open-collector output by programmable controller: 250 kHz (When the pulse duty is 50%) Negative Logic Pulse Input							
Operating Environment	Ambient Temperature	0 to +50°C (Non-freezing)						
	Ambient Humidity	85% or less (Non-condensing)						
	Surrounding Atmosphere	No corrosive gas or dust. No water or oil.						

- For the type with a installation plate, the box □ in the product name indicates the driver shape **B** (with installation plate).
- For the right angle type with a installation plate, the box □ in the product name indicates the connector shape **R** (right angle).

Dimensions (Unit: mm)

● Right Angle Type with Installation Plate

Product Name	Mass [kg]
CVD205BR-K	0.06
CVD206BR-K	
CVD215BR-K	
CVD223BR-K	
CVD223FBR-K	
CVD228BR-K	
CVD503BR-K	
CVD507BR-K	
CVD512BR-K	
CVD514BR-K	
CVD518BR-K	
CVD524BR-K	

● Included

Connector Housing: 51103-0200 (Molex)
51103-0500 (Molex)
51103-1200 (Molex)

Contact: 50351-8100 (Molex)

Product Name	Mass [kg]
CVD242BR-K	0.07
CVD245BR-K	
CVD528BR-K	
CVD538BR-K	

● Included

Connector Housing: 51067-0200 (Molex)
51067-0500 (Molex)
51103-1200 (Molex)

Contact: 50217-9101 (Molex)
50351-8100 (Molex)

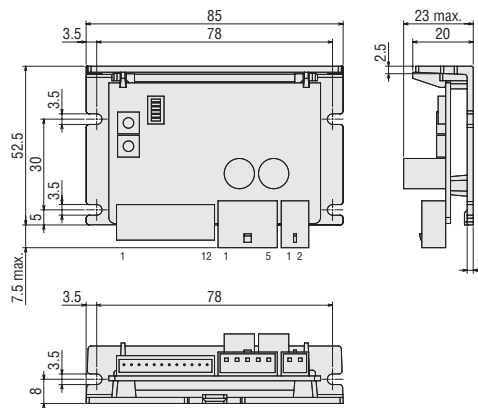
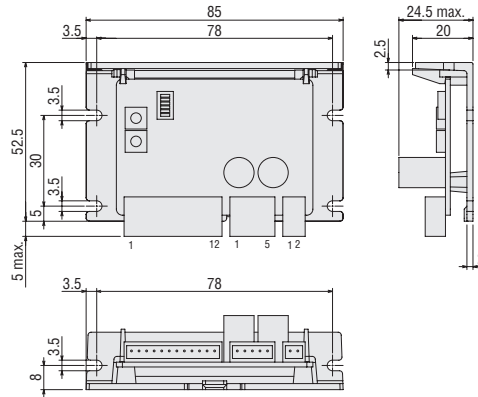

● With Installation Plate

Product Name	Mass [kg]
CVD205B-K	0.06
CVD206B-K	
CVD215B-K	
CVD223B-K	
CVD223FB-K	
CVD228B-K	
CVD503B-K	
CVD507B-K	
CVD512B-K	
CVD514B-K	
CVD518B-K	
CVD524B-K	

● Included

Connector Housing: 51103-0200 (Molex)
51103-0500 (Molex)
51103-1200 (Molex)

Contact: 50351-8100 (Molex)

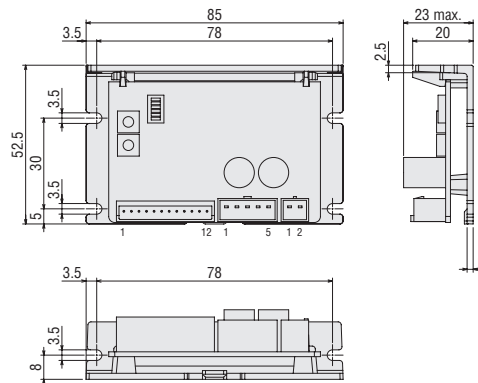
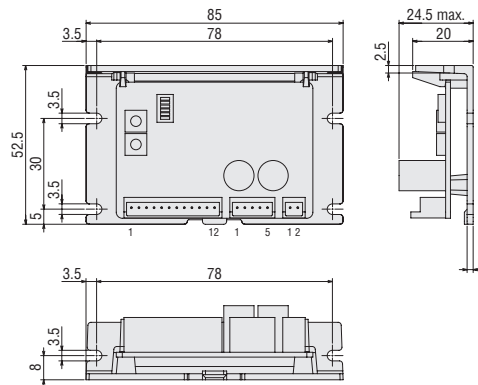

Product Name	Mass [kg]
CVD242B-K	0.07
CVD245B-K	
CVD528B-K	
CVD538B-K	

● Included

Connector Housing: 51067-0200 (Molex)
51067-0500 (Molex)
51103-1200 (Molex)

Contact: 50217-9101 (Molex)
50351-8100 (Molex)

2-Phase
Motors
PKP

Features
Product
Line

Product
Number
Product Line

Standard
Type

High-
Resolution
Type

Flat
Type

SH Geared
Type

CS Geared
Type

Common
Specifications

Inner
Wiring
of Motor

5-Phase
Motors
PKP

Features
Product
Line

Product
Number
Product Line

Standard
Type

High-
Resolution
Type

TS Geared
Type

Common
Specifications

Motor
Pin
Arrangement

Drivers for
2-Phase/5-Phase
Motors

Peripheral
Equipment

● Without Installation Plate

Product Name	Mass [kg]
CVD205-K	0.02
CVD206-K	
CVD215-K	
CVD223-K	
CVD223F-K	
CVD228-K	
CVD503-K	
CVD507-K	
CVD512-K	
CVD514-K	
CVD518-K	
CVD524-K	

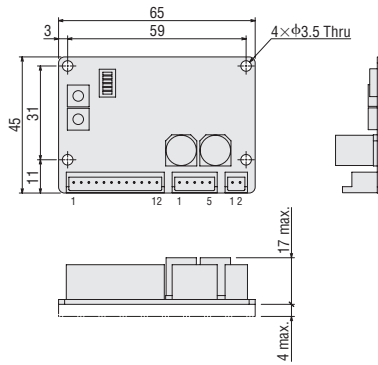

● Included

Connector Housing: 51103-0200 (Molex)
 51103-0500 (Molex)
 51103-1200 (Molex)
 Contact: 50351-8100 (Molex)

■ List of Applicable Motors

● Bipolar Driver for 2-Phase Stepper Motors

Driver Product Name			Motor Drive Current	Connector Type	Applicable Motor
Right Angle with Installation Plate	With Installation Plate	Without Installation Plate			Motor Product Name
CVD205BR-K	CVD205B-K	CVD205-K	0.5 A/Phase	Model C	PKP21 3D
CVD206BR-K	CVD206B-K	CVD206-K	0.6 A/Phase	Model C Model D	PKP21 4D PKP20 3D
CVD215BR-K	CVD215B-K	CVD215-K	1.5 A/Phase	Model B Model C	PKP22 □ D, PKP23 □ D15, PKP24 □ D15 PKP26 2FD
CVD223BR-K	CVD223B-K	CVD223-K	2.3 A/Phase	Model B	PKP23 □ D23, PKP24 □ D23
CVD223FBR-K	CVD223FB-K	CVD223F-K	2.3 A/Phase	Model A	PKP24 □ D
CVD228BR-K	CVD228B-K	CVD228-K	2.8 A/Phase	Model A Model B	PKP25 □ D, PKP26 □ D14, PKP26 □ D28 PKP26 □ D28
CVD242BR-K	CVD242B-K	—	4.2 A/Phase	Model A	PKP26 □ D42
CVD245BR-K	CVD245B-K	—	4.5 A/Phase	Model C	PKP29 □ D

- A number indicating the length of the motor case is entered where the box □ is located within the names of the applicable motors.
- For high-resolution type, the code **M** (high-resolution type) indicating the motor type is entered where the box ■ is located within the names of the applicable motors.
- The applicable motors are listed such that the available combinations with the driver are distinguishable. Combinations with the encoder type and geared type are also available. For details on the product name, please see the Oriental Motor website.

Note

● Be sure to set the driver current at or below the motor rated current. If the motor rated current is exceeded, the product will be damaged.

● Driver for 5-Phase Stepper Motors

Driver Product Name			Motor Drive Current	Applicable Motor
Right Angle with Installation Plate	With Installation Plate	Without Installation Plate		
CVD503BR-K	CVD503B-K	CVD503-K	0.35 A/Phase	PK51 3, PK52 □
CVD507BR-K	CVD507B-K	CVD507-K	0.75 A/Phase	PK52 □ H, PK54 □
CVD512BR-K	CVD512B-K	CVD512-K	1.2 A/Phase	PKP52 □
CVD514BR-K	CVD514B-K	CVD514-K	1.4 A/Phase	PK56 □
CVD518BR-K	CVD518B-K	CVD518-K	1.8 A/Phase	PKP54 □
CVD524BR-K	CVD524B-K	CVD524-K	2.4 A/Phase	PKP56 □ FN24, PKP56 □ FMN
CVD528BR-K	CVD528B-K	—	2.8 A/Phase	PKP56 □ N28, PK56 □ H, PK59 □ H
CVD538BR-K	CVD538B-K	—	3.8 A/Phase	PKP56 □ FN38

- A number indicating the length of the motor case is entered where the box □ is located within the names of the applicable motors.
- The applicable motors are listed such that the available combinations with the driver are distinguishable. Combinations with the encoder type and geared type are also available. For details on the product name, please see the Oriental Motor website.

Note

● Be sure to set the driver current at or below the motor rated current. If the motor rated current is exceeded, the product will be damaged.

Connection and Operation

Names and Functions of Driver Parts

1 Signal Monitor Indicators

◇ LED Indicator

Indication	Color	Function	Lighting Condition
PWR/ALM	Green	Power Supply Indication	When power is applied
	Red	Alarm Indication	When a protective function is activated (blinking)

◇ Alarm Contents

Blink Count	Function	Operating Condition
2	Overheat Protection	When the temperature of the driver board reaches 85°C
3	Overvoltage Protection	When the power supply voltage exceeds its permissible value When a large inertial load is stopped suddenly When a large load is hoisted
5	Overcurrent Protection	When an excessive current flows to the motor's output circuit
9	EEPROM Error	When data of the driver is damaged
Lighting	CPU Error	When the CPU driver malfunctions

2 Function Setting Switch

Indication	No.	Function
1P/2P	1	Switches the pulse input mode between 1-pulse input mode and 2-pulse input mode.
OFF/SD	2	Switches the smooth drive function between enabled and disabled.
R2/R1	3	Use in combination with the step angle setting switch to set the step angle.
STOP	4	Switches the standstill current of motors to 25% or 50%.
OFF/FIL	5	Switches the command filter between enabled and disabled.
–	6	Not used.

3 Step Angle Setting Switch

Indication	Function
STEP	Use in combination with the R2/R1 switch to set the step angle.

Step Angle Setting Switch (STEP) Scale	R2/R1 Switch: When Set to ON (R1)		R2/R1 Switch: When Set to OFF (R2)	
	Resolution (P/R)	Step Angle	Resolution (P/R)	Step Angle
0	500	0.72°	200	1.8°
1	1000	0.36°	400	0.9°
2	1250	0.288°	800	0.45°
3	2000	0.18°	1000	0.36°
4	2500	0.144°	1600	0.225°
5	4000	0.09°	2000	0.18°
6	5000	0.072°	3200	0.1125°
7	10000	0.036°	5000	0.072°
8	12500	0.0288°	6400	0.05625°
9	20000	0.018°	10000	0.036°
A	25000	0.0144°	12800	0.028125°
B	40000	0.009°	20000	0.018°
C	50000	0.0072°	25000	0.0144°
D	62500	0.00576°	25600	0.0140625°
E	100000	0.0036°	50000	0.0072°
F	125000	0.00288°	51200	0.00703125°

4 Running Current Setting Switch

Indication	Function
RUN	Sets the motor running current.

5 I/O Signal Connector

Indication	Pin No.	I/O	Signal Name	Function
CN3	1	Input	CW+ (PLS+)	Rotates the motor in the CW direction. (Operation command pulse signal when in 1-pulse input mode)
	2		CW- (PLS-)	
	3		CCW+ (DIR+)	Rotates the motor in the CCW direction. (Rotation direction signal when in 1-pulse input mode)
	4		CCW- (DIR-)	
	5		AWO+	Stop motor excitation.
	6		AWO-	
	7	CS+	Switches the step angle.	
	8	CS-		
	9	Output	ALM+	Outputs the alarm status for the driver (normally closed).
	10		ALM-	
	11		TIM+	Output when the state of excitation of the motor is the excitation home position.
	12		TIM-	

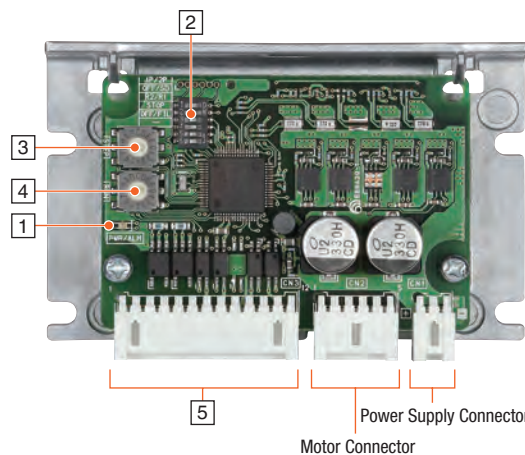

● Difference in the Motor Responsiveness Depending on the Command Filter (OFF/FIL Switch)

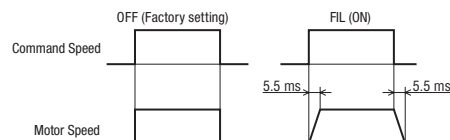

● Compared to the standard type, the high-resolution type has 2 times the resolution and 1/2 the step angle.

Example: When the R2/R1 switch is set to ON (R1) and the STEP switch is set to "0"

Resolution of High-Resolution Type: $500 \times 2 = 1000$

Step Angle of High-Resolution Type: $0.72/2 = 0.36^\circ$

● With the geared types, the actual step angle is the value obtained by dividing the step angle by the gear ratio.

2-Phase
Motors
PKP

Features
Product
Line

Product
Number
Product Line

Standard
Type

High-
Resolution
Type

Flat
Type

SH Geared
Type

CS Geared
Type

Common
Specifications

Inner
Wiring
of Motor

5-Phase
Motors
PKP

Features
Product
Line

Product
Number
Product Line

Standard
Type

High-
Resolution
Type

TS Geared
Type

Common
Specifications

Motor
Pin
Arrangement

Drivers for
2-Phase/5-Phase
Motors

Peripheral
Equipment

Connection Diagrams

- When the Input Signal Voltage is 5 VDC
- ◇ When the pulse input is the line driver

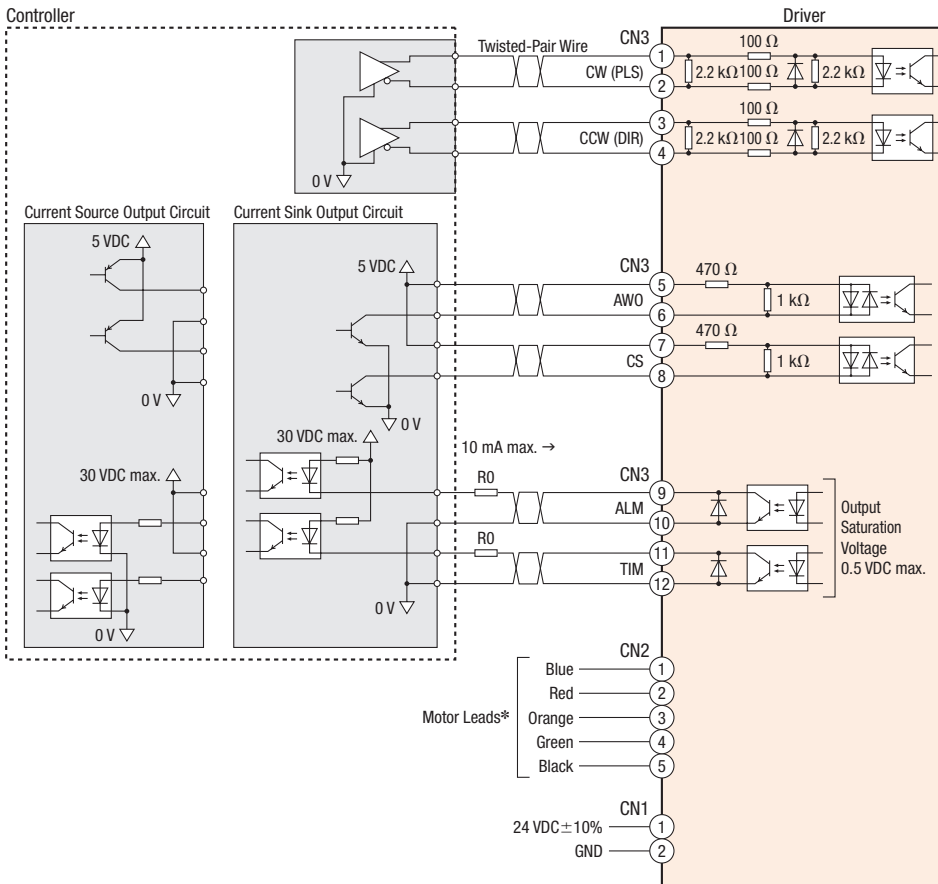

*The pin arrangement of the connector differs depending on the motor. See the connection table below for details.

◇ Connection Table of 2-Phase CVD Drivers

- Motor: 2-Phase **PKP/PK** Series Bipolar 4 Lead Wires
- Driver: Bipolar Driver for 2-Phase Stepper Motors

Driver CN2 Pin No.	Model A		Model B		Model C		Model D	
	Pin No.	Color	Pin No.	Color	Color	Pin No.	Color	
1	4	Blue	1	Blue	Blue	3	Blue	
2	5	Red	3	Red	Red	4	Red	
3	-	-	-	-	-	-	-	
4	2	Green	6	Green	Green	2	Green	
5	1	Black	4	Black	Black	1	Black	

● The colors in the table represent colors of the lead wires of the connection cables sold separately.

Note

● The pin arrangement varies depending on the model. It will not rotate normally if the connection is wrong.

◇ Connection Table of 5-Phase CVD Drivers

- Motor: 5-Phase **PKP/PK** Series
- Driver: Driver for 5-Phase Stepper Motors

Driver CN2 Pin No.	Model A		Model B		Model C	
	Pin No.	Color	Pin No.	Color	Color	Color
1	5	Blue	1	Blue	Blue	Blue
2	4	Red	2	Red	Red	Red
3	3	Orange	3	Orange	Orange	Orange
4	2	Green	4	Green	Green	Green
5	1	Black	5	Black	Black	Black

● The colors in the table represent colors of the lead wires of the connection cables sold separately.

◇ When the pulse input is open collector

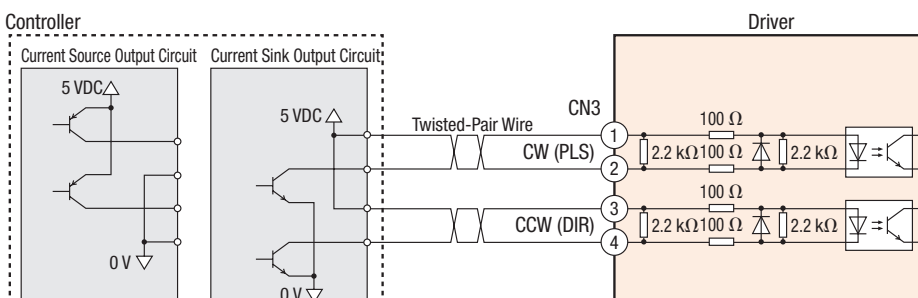

● When the Input Signal Voltage is 24 VDC

◇ When the pulse input is open collector

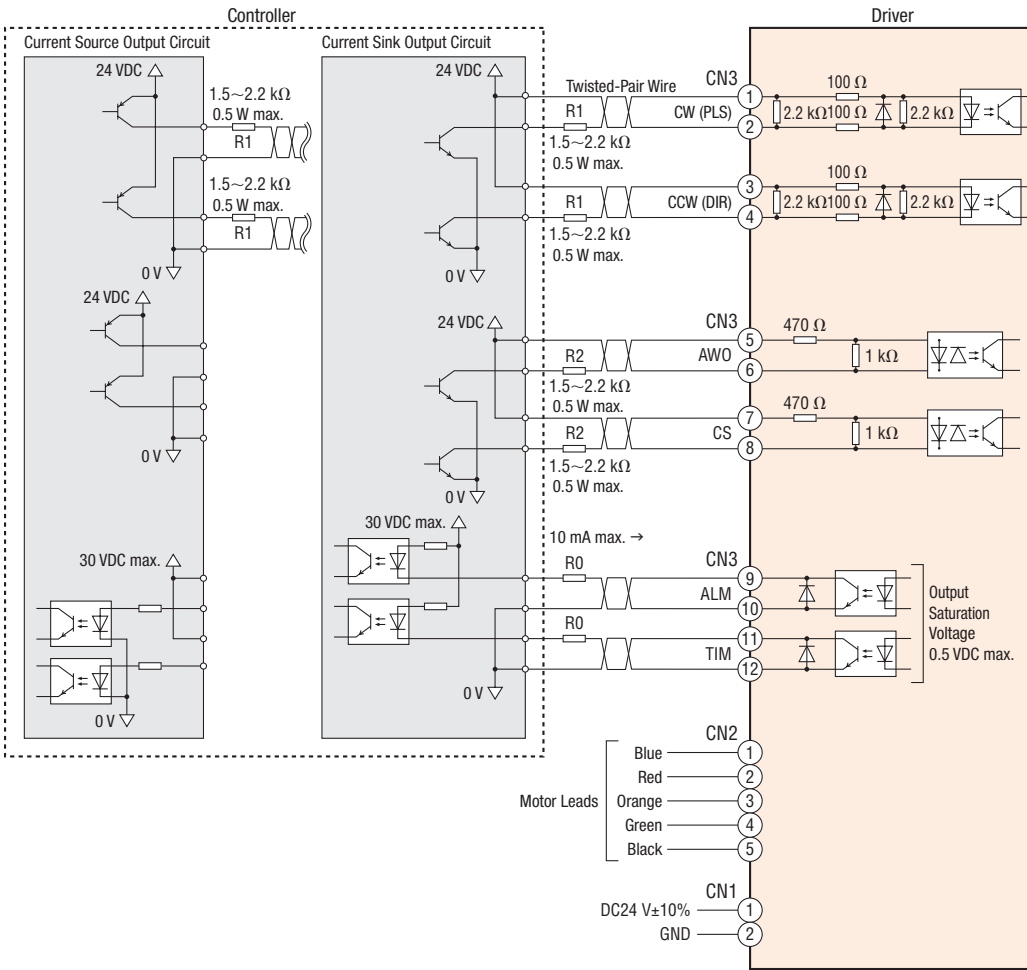

[Notes on Wiring]

◇ I/O Signal Connection

● Input signal

Use 5 VDC for the CW input and CCW input signals. If voltage exceeding 5 VDC is applied, connect an external resistor R1 so that the current becomes 7 - 20 mA.

Example: When connecting to 24 VDC, R1 should be 1.5 - 2.2 kΩ, 0.5 W or more

Use 5 VDC for the AWO input and CS input signals. If voltage exceeding 5 VDC is applied, connect an external resistor R2 so that the current becomes 5 - 15 mA.

Example: When connecting to 24 VDC, R2 should be 1.5 - 2.2 kΩ, 0.5 W or more

● Output signal

Use output signals at 30 VDC 10 mA max. When the current value exceeds 10 mA, connect an external resistor R0.

● Either a twisted-pair wire or shielded wire is recommended for the I/O signal cable.

● Note that as the length of the pulse line increases, the max. transmission frequency decreases, and keep the wiring length as short as possible (2 m max.).

● Provide a distance of 100 mm min. between the signal lines and power lines (such as power supply lines and motor lines).

◇ Power Supply Connection

● Incorrect polarities of the DC power-supply input will damage the driver. Make sure that the polarity is correct before turning the power on.

◇ Motor Cable Extension

● Up to 3 cables can be connected between the motor and driver.

● Maximum extension length is 10 m. (5 m for **CVD242**, **CVD528** or **CVD538**.)

◇ General

● A separate hand crimp tool is required to crimp the connector and lead wires included with the driver. Connection cable sets which are available as accessories (sold separately) have already had their lead wires crimped.

● If a specific wiring and layout causes the motor cable or power supply cable to generate a noise problem, shield the cable or use ferrite cores.

2-Phase
Motors
PKP

Features
Product
Line

Product
Number
Product Line

Standard
Type

High-
Resolution
Type

Flat
Type

SH Geared
Type

CS Geared
Type

Common
Specifications

Inner
Wiring
of Motor

5-Phase
Motors
PKP

Features
Product
Line

Product
Number
Product Line

Standard
Type

High-
Resolution
Type

TS Geared
Type

Common
Specifications

Motor
Pin
Arrangement

Drivers for
2-Phase/5-Phase
Motors

Peripheral
Equipment

Bipolar Driver for 2-Phase Stepper Motors Driver for 5-Phase Stepper Motors CVD Series RS-485 Communication Type

Product Number

CVD 2 B R - K R

① ② ③ ④ ⑤ ⑥

①	Series Name	CVD: CVD Series
②		2: 2-Phase 5: 5-Phase
③	Driver Configuration	B: With an Installation Plate
④	Connector Configuration	R: Right Angle
⑤	Power Supply Input	K: DC Power Supply
⑥	Product Line	R: RS-485 Communication Type

Product Line

● Bipolar Driver for 2-Phase Stepper Motors

◇ Right Angle Type with Installation Plate

Product Name
CVD2BR-KR

◇ With Installation Plate

Product Name
CVD2B-KR

● Driver for 5-Phase Stepper Motors

◇ Right Angle Type with Installation Plate

Product Name
CVD5BR-KR

◇ With Installation Plate

Product Name
CVD5B-KR

Specifications



Driver Product Name		CVD2B□-KR	CVD5B□-KR
Drive Method		Microstep Drive, Bipolar Constant Current Drive Method	
Power Supply Voltage		24 VDC±10%	
Input Current		A 0.5~3.0	0.6~3.0
Interface	Control Input	7 points, Photocoupler	
	Control Output	2 points, Photocoupler and Open-Collector	
	Field Network	Modbus RTU (RS-485 communication)	
Operating Environment (In operation)	Ambient Temperature	0~+50°C (Non-freezing)	
	Ambient Humidity	85% or less (Non-condensing)	
	Atmosphere	No corrosive gases or dust. The product should not be exposed to water, oil or other liquids.	

● For the right angle type with installation plate, an **R** (right angle) indicating the connector configuration is specified where the □ box is located in the driver product name.

RS-485 Communication Specifications

Electrical Characteristics	Complies with EIA-485. Use twisted-pair wire. The max. total extension length is 10 m.
Communication Mode	Half duplex and start-stop synchronization (Data: 8 bits, stop bit: 1 bit or 2 bits, parity: none, even, or odd)
Baud Rate	9,600 bps, 19,200 bps, 38,400 bps, 57,600 bps, 115,200 bps, and 230,400 bps are available
Protocol	Modbus RTU mode
Connection Type	Up to 31 units can be connected to a single host system.

Dimensions (Unit: mm)

Right Angle Type with Installation Plate

Product Name	Mass [kg]
CVD2BR-KR	0.065
CVD5BR-KR	

● Applicable Connector (Molex)

Power Connector (CN1)

Connector Housing: 43645-0200 (Molex)
Contact: 43030-0001 (Molex)

Motor Connector (CN2)

Connector Housing: 51103-0500 (Molex)
Contact: 50351-8100 (Molex)

RS-485 Communication Connector (CN4, CN5)

Connector Housing: PAP-03V-S (J.S.T.MFG.CO.,LTD.)
Contact: SPHD-001T-P0.5 or SPHD-002T-P0.5 (J.S.T.MFG.CO.,LTD.)

I/O signal connector (CN6)

Connector Housing: PHDR-12VS (J.S.T.MFG.CO.,LTD.)
Contact: SPHD-001T-P0.5 (J.S.T.MFG.CO.,LTD.)

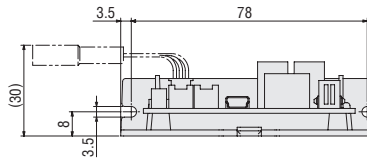
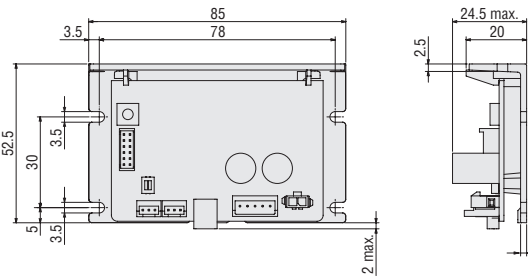
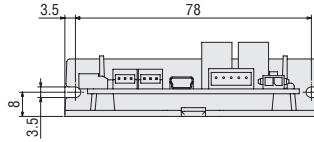
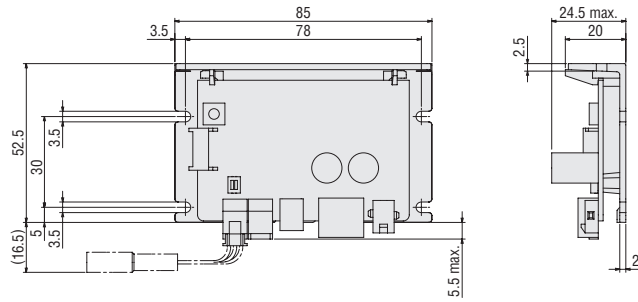

With Installation Plate

Product Name	Mass [kg]
CVD2B-KR	0.065
CVD5B-KR	

● Applicable Connector (Molex)

Same as the right angle with installation plate.

List of Applicable Motors

Driver for 2-Phase Stepper Motors

Driver Product Name		Motor Drive Current	Input Current A	Applicable Motor
Right Angle with Installation Plate	With Installation Plate			
CVD2BR-KR	CVD2B-KR	0.5 A/Phase	0.5	PKP213D05 □
		0.6 A/Phase	0.5	PKP203D06 □, PKP214D06 □
		0.85 A/Phase	0.8	PKP24 □ D08 □ 2
		1.4 A/Phase	1.3	PKP26 □ D14 □ 2
		1.5 A/Phase	1.9	PKP22 □ D15 □, PKP22 □ MD15 □, PKP22 □ D15 □ 2 , PKP23 □ D15 □, PKP24 □ D15 □, PKP24 □ MD15 □, PKP262FD15A
				PKP24 □ D15 □ 2 , PKP24 □ MD15 □ 2
		2.3 A/Phase	2.0	PKP23 □ D23 □, PKP24 □ D23 □ 2 , PKP24 □ D23 □
2.8 A/Phase	3.0	PKP25 □ D28 □ A2 , PKP26 □ D28 □ 2 , PKP26 □ D28 □, PKP26 □ MD28 □ 2 , PKP26 □ MD28 □		

Driver for 5-Phase Stepper Motors

Driver Product Name		Motor Drive Current	Input Current A	Applicable Motor
Right Angle with Installation Plate	With Installation Plate			
CVD5BR-KR	CVD5B-KR	0.35 A/Phase	0.6	PK513 , PK52 □ P
		0.75 A/Phase	1.4	PK52 □ H , PK54 □
		1.2 A/Phase	1.7	PKP52 □
		1.4 A/Phase	1.8	PK56 □
		1.8 A/Phase	2.8	PKP54 □ N18 □ 2 , PKP54 □ N18 □, PKP54 □ MN
		2.4 A/Phase	3.0	PKP56 □ FN24 □ 2 , PKP56 □ FMN

● A number indicating the length of the motor case is entered where the box □ is located within the names of the applicable motors.

● Either **A** (single shaft) or **B** (double shaft) indicating the configuration is specified where the box □ is located in the names of the applicable motors.

● The applicable motors are listed such that the available combinations with the driver are distinguishable.

Combinations with the encoder type and geared type are also available.

For details on the product name, please see the Oriental Motor website.

[Note]

● Be sure to set the driver current at or below the motor rated current. If the motor rated current is exceeded, the product will be damaged.

2-Phase Motors PKP

Features Product Line

Product Number Product Line

Standard Type

High-Resolution Type

Flat Type

SH Geared Type

CS Geared Type

Common Specifications

Inner Wiring of Motor

5-Phase Motors PKP

Features Product Line

Product Number Product Line

Standard Type

High-Resolution Type

T5 Geared Type

Common Specifications

Motor Pin Arrangement

Drivers for 2-Phase/5-Phase Motors

Peripheral Equipment

Connection and Operation

Names and Functions of Driver Parts

1 Signal Monitor Indicators

◇ LED Indicators

Indication	Color	Function	Lighting Condition
PWR/ALM	Green	Power Supply Indication	When power is applied
	Red	Alarm Indication	When a protective function is activated (blinking)
C-DAT/C-ERR	Green	Communication Indication	When communication data is being sent or received
	Red	Communication Error Indication	When communication data is in error

2 Terminating Resistor Setting Switch

Indication	No.	Function
SW2	1	Set the RS-485 communication terminating resistor (120 Ω) (factory setting: OFF for both No.1 and No.2).
	2	

3 Motor Setting Switch

Indication	Function
SW1	Set the applicable motor (factory setting: 0).

4 USB Communication Connector (CN3)

◇ USB Communication Cable Specifications

Specifications	USB 2.0 (Full speed)
	Length: 3 m or less
Cables	Configuration: A to mini B

5 RS-485 Communication Connector (CN4, CN5)

Connect when controlling with RS-485 communication. If connecting multiple drivers, connect the RS-485 communication cable (sold separately) to either the CN4 or CN5 connector. Another driver can be connected to the open connectors.

Internal Input Circuit

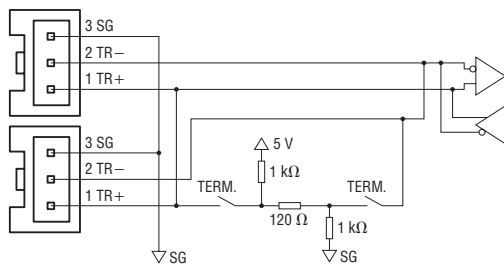

Pin No.	Signal Name	Description
1	TR+	RS-485 Communication Signal (+)
2	TR-	RS-485 Communication Signal (-)
3	SG	Signal GND

6 I/O Signal Connector (CN6)

Indication	Pin No.	Signal Name	Description
CN6	1	IN-COM	Input Common
	2	IN0	Control Input 0 [FW-POS] Execute continuous operation in the FWD direction.
	3	IN1	Control Input 1 [RV-POS] Execute continuous operation in the RVS direction.
	4	IN2	Control Input 2 [STOP] Stop the motor.
	5	IN3	Control Input 3 [ALM-RST] Reset the alarms.
	6	IN4	Control Input 4 [HOMES] The signal input from the mechanical home sensor.
	7	IN5	Control Input 5 [FW-LS] The signal input from the FWD direction limit sensor.
	8	IN6	Control Input 6 [RV-LS] The signal input from the RVS direction limit sensor.
	9	OUT0	Control Output 0 [ALM-B] Output the alarm status for the driver (B contact).
	10	OUT1	Control Output 1 [TIM] Output each time the motor output shaft rotates 7.2° from home.
	11	OUT-COM	Output Common
	12	N.C.	N.C.

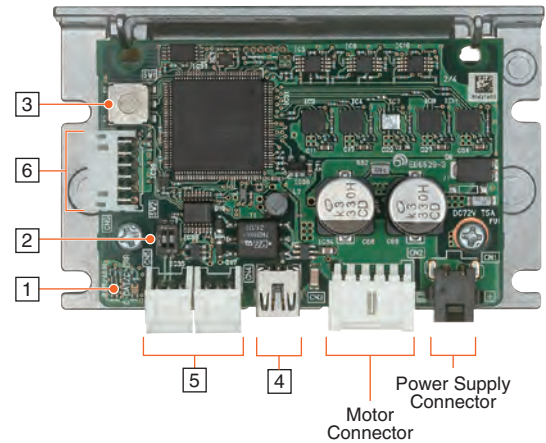

RS-485 Communication Wire



● Alarm Contents

Blink Count	Function	Operating Condition
5	Overcurrent Protection	When an excessive current flows to the motor's output circuit
2	Main Circuit Overheat Protection	When the temperature of the driver board reaches 85°C
3	Overvoltage Protection	When the power supply voltage exceeds its permissible value When a large inertial load is stopped suddenly When a large load is hoisted
3	Undervoltage	When the power supply suddenly shuts down or the voltage is insufficient
2	Command Pulse Error	When the command pulse frequency exceeds the specification value
9	EEPROM Error	When data of the driver is damaged
7	Return-to-Home Not Completed	When absolute positioning operation starts with the coordinates not fixed
7	±LS Simultaneous Input	Both FW-LS input and RV-LS input are detected when there is an alarm for the "FW-LS/RV-LS input operation" parameter Return-to-home operation executed when both FW-LS input and RV-LS input are detected
7	±LS Reverse Connection	When a reverse LS input to the operation direction is detected during return-to-home operation in either 3-sensor mode or 2-sensor mode
7	Return-to-Home Operation Error	When the FW-LS and RV-LS sensor and the HOME sensor are installed near one another When the HOME sensor is exceeded during a deceleration stop during return-to-home operation in 1-direction rotation mode
7	HOMES Not Detected	When HOMES input is not detected between the FW-LS input and RV-LS input during return-to-home operation in 3-sensor mode
7	TIM, SLIT Signal Error	When TIM output and SLIT input cannot be detected during return-to-home operation
7	Hardware Overtravel	Either FW-LS input or RV-LS input is detected when there is an alarm for the "FW-LS/RV-LS input operation" parameter
7	Software Overtravel	When the software limit is reached when there is an alarm for the "Software overtravel" parameter
7	Return-to-Home Operation Offset Error	When either FW-LS input or RV-LS is detected during offset traveling during return-to-home operation
7	Operating Data Error	When a positioning SD operation is executed with operating speed 0 data
7	RS-485 Communication Error	When a set number of consecutive errors occurs with the "Communication error alarm" parameter in RS-485 communication
7	RS-485 Communication Timeout	When there is no communication with the host system even when the set time in the "Communication timeout" parameter has elapsed
Lit up	CPU Error	When the CPU driver malfunctions

2-Phase
Motors
PKP

Features
Product
Line

Product
Number
Product Line

Standard
Type

High-
Resolution
Type

Flat
Type

SH Geared
Type

CS Geared
Type

Common
Specifications

Inner
Wiring
of Motor

5-Phase
Motors
PKP

Features
Product
Line

Product
Number
Product Line

Standard
Type

High-
Resolution
Type

TS Geared
Type

Common
Specifications

Motor
Pin
Arrangement

Drivers for
2-Phase/5-Phase
Motors

Peripheral
Equipment

Connection Diagrams

◇ Connection with Current Sink Output Circuit

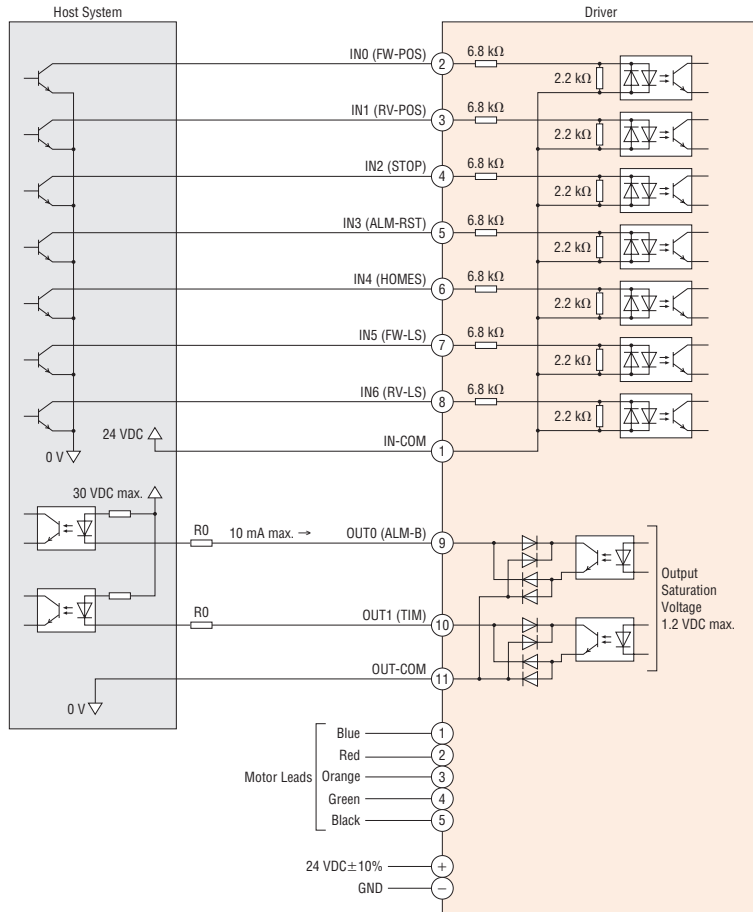

[Notes on Wiring]

◇ I/O Signal Connection

- Output Signals
Use output signals at 30 VDC 10 mA max. When the current value exceeds 10 mA, connect an external resistor R0.
- Either a twisted-pair wire or shielded wire is recommended for the I/O signal cable.
- Keep the cable as short as possible (under 2 m) to suppress the effects of noise.
- Provide a distance of 100 mm min. between the signal lines and power lines (such as power supply lines and motor lines).

◇ Power Supply Connection

- Incorrect polarities of the DC power-supply input will damage the driver.
Make sure that the polarity is correct before turning the power on.

◇ Motor Connection

- Up to three cables can be used to connect the motor and driver.
- The maximum extension length is 10 m.

◇ General

- A separate hand crimp tool is required to crimp the connector and lead wires included with the driver. The separately sold connection cables have already had their lead wires crimped.
- If a specific wiring and layout causes the motor cable or power supply cable to generate a noise problem, shield the cable or use ferrite cores.

◇ Connection with Current Source Output Circuit

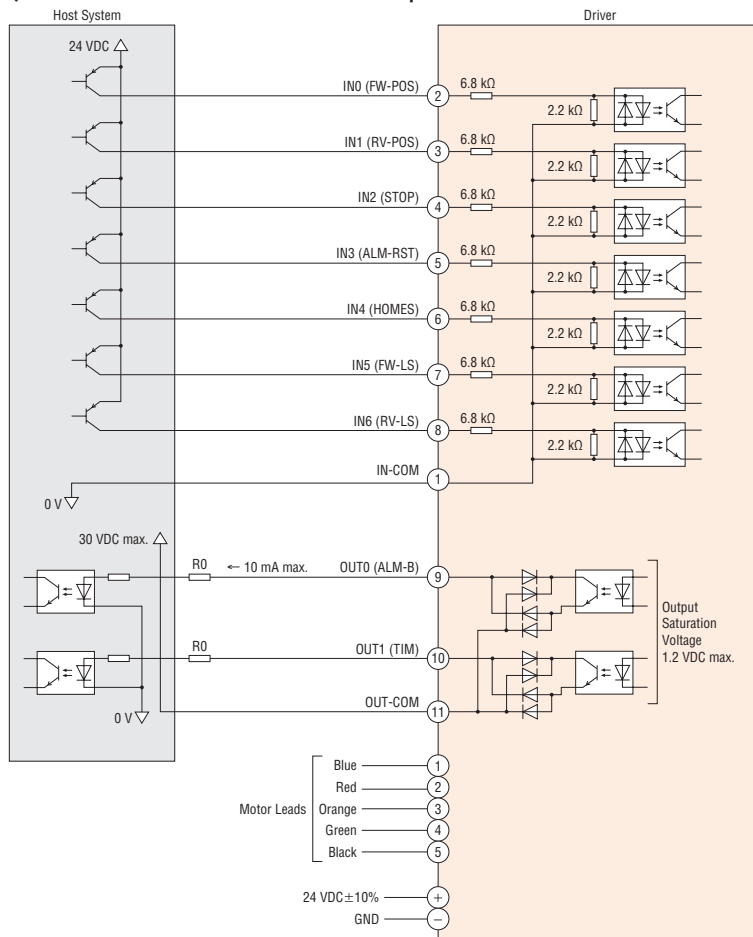

◇ 2-Phase CVD Driver Connection Table

- Motor: 2-Phase **PKP/PK** Series Bipolar 4 Lead Wires
- Driver: Bipolar Driver for 2-Phase Stepper Motors

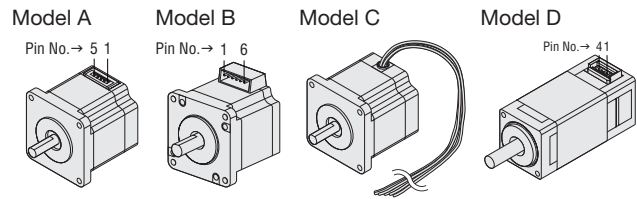

Driver CN2 Pin No.	Model A		Model B		Model C	Model D	
	Pin No.	Color	Pin No.	Color	Color	Pin No.	Color
1	4	Blue	1	Blue	Blue	3	Blue
2	5	Red	3	Red	Red	4	Red
3	—	—	—	—	—	—	—
4	2	Green	6	Green	Green	2	Green
5	1	Black	4	Black	Black	1	Black

● The colors in the table indicate the colors of the lead wires in the separately sold connection cables.

Note

- The pin arrangement varies depending on the model. It will not rotate normally if the connection is wrong.

◇ 5-Phase CVD Driver Connection Table

- Motor: 5-Phase **PKP/PK** Series
- Driver: Driver for 5-Phase Stepper Motors

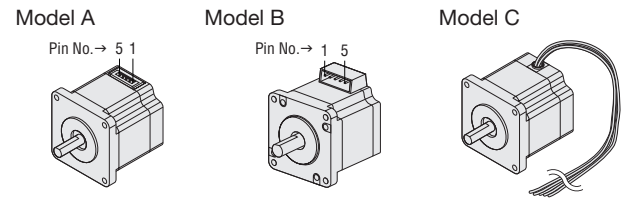

Driver CN2 Pin No.	Model A		Model B		Model C
	Pin No.	Color	Pin No.	Color	Color
1	5	Blue	1	Blue	Blue
2	4	Red	2	Red	Red
3	3	Orange	3	Orange	Orange
4	2	Green	4	Green	Green
5	1	Black	5	Black	Black

● The colors in the table indicate the colors of the lead wires in the separately sold connection cables.

2-Phase Motors PKP

Features Product Line

Product Number Product Line

Standard Type

High-Resolution Type

Flat Type

SH Geared Type

CS Geared Type

Common Specifications

Inner Wiring of Motor

5-Phase Motors PKP

Features Product Line

Product Number Product Line

Standard Type

High-Resolution Type

TS Geared Type

Common Specifications

Motor Pin Arrangement

Drivers for 2-Phase/5-Phase Motors

Peripheral Equipment

Cables

Motor Cables

① Connection Cables Motor Side



These cables have a connector on motor side. Refer to pages on motor specifications and dimensions for "Applicable Motors" and "Cable Dimensions."

◇ Product Line (For 2-Phase Bipolar Motors)

Product Name	Length L [m]
LC2B06A	0.6
LC2B06B	0.6
LC2B06C	0.6
LC2B06E	0.6

◇ Product Line (For 2-Phase Unipolar Motors)

Product Name	Length L [m]
LC2U06A	0.6
LC2U10A	1
LC2U06B	0.6
LC2U10B	1
LC2U06C	0.6
LC2U10C	1
LC2U06E	0.6

◇ Product Line (For 5-Phase Motors)

Product Name	Length L [m]
LC5N06A	0.6
LC5N10A	1
LC5N06B	0.6
LC5N10B	1
LC5N06C2	0.6
LC5N10C2	1
LC5N06E	0.6

Encoder Connection Cable

① Lead Wire



An encoder connection cable with an encoder connector on the motor end. Check the specifications and dimensions page of each motor for the cable dimensions.

◇ Product Line

Product Name	Applicable Motor	Length L [m]	Conductor AWG
LCE08A-006	2-Phase/5-Phase Motors with Encoder	0.6	26 (0.13 mm ²)

- A voltage output type cable is also available. For details, please contact your nearest Oriental Motor sales office.
- For dimensions, please see the Oriental Motor website.

Electromagnetic Brake Connection Cable

① Lead Wire



An electromagnetic brake connection cable with an electromagnetic brake connector on the motor end. Can be used on electromagnetic brakes with the connector connection method. Check the specifications and dimensions page of each motor for the cable dimensions.

◇ Product Line

Product Name	Applicable Motor	Length L [m]	Conductor AWG
LCM02A-006	PKP24□M2	0.6	22 (0.3 mm ²)
LCM02A-010	PKP26□M2	1	

Electromagnetic Brake Connection Cable

① Lead Wire

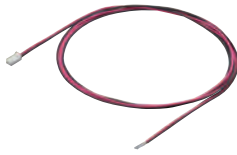

An electromagnetic brake connection cable with an electromagnetic brake connector on the motor end. Can be used on electromagnetic brakes with the connector connection method. Check the specifications and dimensions page of each motor for the cable dimensions.

◇ Product Line

Product Name	Applicable Motor	Length L [m]	Conductor AWG
LCM02A-006	PKP24□M2	0.6	22
LCM02A-010	PKP26□M2	1	(0.3 mm ²)

2-Phase
Motors
PKP

Features
Product
Line

Product
Number
Product Line

Standard
Type

High-
Resolution
Type

Flat
Type

SH Geared
Type

CS Geared
Type

Common
Specifications

Inner
Wiring
of Motor

5-Phase
Motors
PKP

Features
Product
Line

Product
Number
Product Line

Standard
Type

High-
Resolution
Type

TS Geared
Type

Common
Specifications

Motor
Pin
Arrangement

Drivers for
2-Phase/5-Phase
Motors

Peripheral
Equipment

Power Supply Cable/I/O Signal Cable Set (RS-485 communication type)

2-Phase Bipolar
5-Phase
Pulse Input

2-Phase Bipolar
5-Phase
RS-485 Communication

Cables

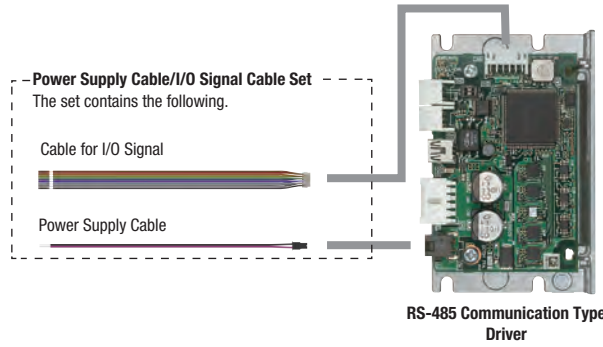

Power supply cables are used to connect the driver and the DC power supply.
I/O signal cables are used to connect the driver and the host control device.
A power supply cable and I/O signal cable come as a set.

Product Line

Product Name	Length L [m]
LHS003CC	0.3
LHS010CC	1

Dimensions (Unit: mm)

Power Supply Cable

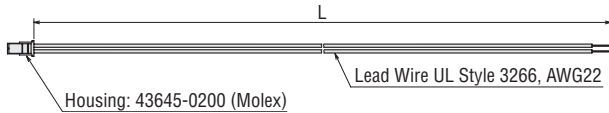

Cable for I/O Signal

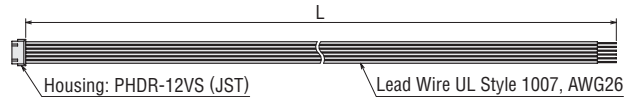

RS-485 Communication Cable (RS-485 communication type)

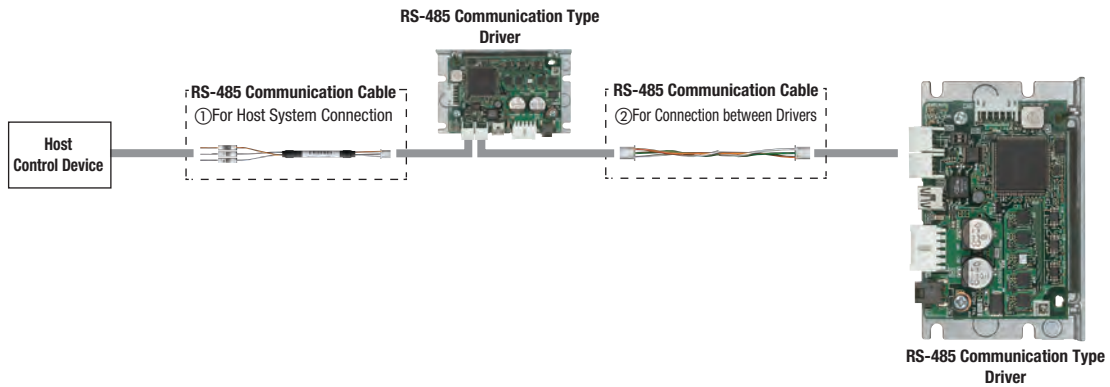

① For Host System Connection

These cables are used to connect the driver and the host control device.

Product Line

Product Name	Length [m]
CC030-RS	3

Dimensions (Unit: mm)

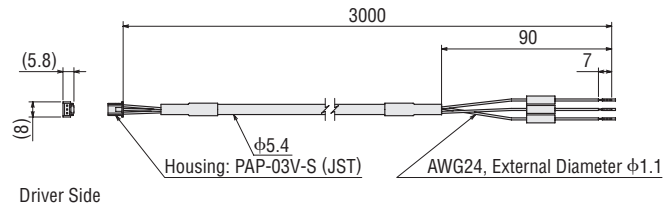

② For Connection between Drivers

These cables are used to connect between drivers.

Product Line

Product Name	Length [m]
LH0015-RWN	0.15

Dimensions (Unit: mm)

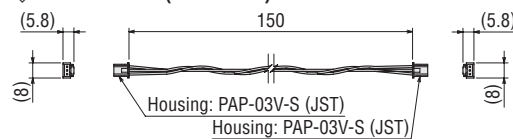

Peripheral Equipment (Sold separately)

Motor Connector Set

This is a set of connector housings and contacts compatible with connector type (model B) motors.
Use this set if extra housings and contacts are necessary, although they are included with the products.

Product Line

Product Name	Applicable Products
CS2U30A	PKP223, PKP225, PKP223M, PKP225M
CS2U30B	PKP233, PKP235, PKP243, PKP244, PKP245, PKP246, PKP243M, PKP244M
CS5N30A	PK513, PKP523, PKP525
CS5N30B	PKP544, PKP546, PKP544M, PKP546M
CS5N30C2	PKP564FM, PKP566FM, PKP569FM

- Each package contains enough housings and contacts for 30 motors. Please order in units of 1 package. The list price shows the price of 1 package.

Note

- A crimp tool is not included. Please prepare separately.



This photograph shows **CS5N30B**.

Mounting Brackets for Circuit Products

This bracket is for installation on a DIN rail.

<MADP07 Application Example>



Product Line

Material: SPCC

Product Name	Applicable Drivers	Surface Treatment
MADP01	CMD21□□P	Electroless nickel plating
MADP01S1	CVD□□□-K	

Clean Dampers

These mechanical dampers are effective for suppressing stepper motor vibration and improving high-speed performance.

They consist of an inertial load and silicon gel sealed inside a plastic case.



Product Line

● Exclusively for the double shaft type.

Product Name	Inertia [kgm ²]	Mass [g]	Motor Frame Size	Applicable Products
D4CL-5.0F	34×10^{-7}	24	28 mm 35 mm 42 mm	PKP223, PKP225, PKP523, PKP525 PKP233, PKP235 PKP243, PKP244, PKP543, PKP544 PKP245, PKP246, PKP545, PKP546
D6CL-6.3F	140×10^{-7}	62	50 mm	PKP254, PKP256, PKP258
D6CL-8.0F	140×10^{-7}	61	56.4 mm 60 mm	PKP264, PKP266, PKP268 PK264, PK266, PKP564, PKP566 PK267, PK269, PKP568, PKP569
D9CL-14F	870×10^{-7}	105	85 mm 90 mm	PKP296, PKP299, PKP2913 PK296, PK596, PK599, PK5913

Temperature environment: -20+80°C

2-Phase
Motors
PKP

Features
Product
Line

Product
Number
Product Line

Standard
Type

High-
Resolution
Type

Flat
Type

SH Geared
Type

CS Geared
Type

Common
Specifications

Inner
Wiring
of Motor

5-Phase
Motors
PKP

Features
Product
Line

Product
Number
Product Line

Standard
Type

High-
Resolution
Type

T5 Geared
Type

Common
Specifications

Motor
Pin
Arrangement

Drivers for
2-Phase/5-Phase
Motors

Peripheral
Equipment