



WELDING TOOLS

PROFILES

Friction welding machines.....	97
Paddle welding tools.....	100
Guiding clamps.....	104
Overlap welding with hot press.....	106
Overlap welding set with Z-paddle.....	111

FLAT BELTS

Heating paddle with joining table.....	113
--	-----

MISCELLANEOUS

Spare Parts & Accessories.....	115
Mandrel welding tools.....	119
LubeSite® Lubricators.....	120

RS02

The unique friction welding machine RS02 for polyurethane profiles eliminates downtime with a perfect weld on each application!

Features at a glance

- No long heating-up and set-up times, spliced within seconds.
- Precise pressure and automatical 0-positioning prevents uneven welds and premature failure.
- Automatic alignment ensures that the belt ends are aligned perfectly.
- Temperature variation is never a concern (no guess-work).
- Without the risk of injury or fire due to hot metal.
- Due to its small size the RS02 press can be used in confined spaces.
- Thanks to its exchangeable jaws the RS02 is suitable for splicing round belts from \varnothing 6 mm and V-belts from 6x4mm made of polyurethane.



original
DESIGN

Scope of delivery:

- 1 pc. Friction welding machine RS02
- 1 set standard profile jaws at your choice
- 1 pc. Torque wrench
- 1 pc. Scissors AS02
- 1 pc. Edge cutter SE02
- 1 pc. Carrying case with durable and predective foam inlay

Dimension (HxWxD): 390 x 105 x 123 mm
Weight: approx. 2450 g, Power: 500 W

Description
RS02, 230V

Order No.
FBWRS02230V



Tutorialvideo:
<https://youtu.be/7GhtkzLiyl>

RS02 AKKU

Battery-operated friction welding machine for polyurethane profiles for improved high-mobility maintenance.

Features at a glance

- Same characteristics as RS02,
but with the following distinguishing features:
- Cordless; battery-operated
 - Larger scope of delivery



original
DESIGN

Scope of delivery:

- 1 pc. Friction welding machine RS02 AKKU
- 1 set standard profile jaws at your choice
- 1 pc. Torque wrench
- 1 pc. Scissors AS04
- 1 pc. Edge cutter SE02
- 2 pcs. Battery pack
- 1 pc. Charger
- 1 pc. Assortment box
- 1 pc. Carrying case with durable and predective foam inlay

Dimension (HxWxD): 390 x 105 x 123 mm
Weight: approx. 2780 g, Power: 18 V 4Ah (72Wh)

Description
RS02 AKKU, 230V

Order No.
FBWRS02A230

Charger



Battery pack



Our Alu clamping jaw range

1 set of jaws consists of 4 parts

Features at a glance

- Please note each belt profile requires a matching set of jaws.
- Therefore, please select the appropriate clamping jaws for the required profile geometry.
- **On request, we also manufacture clamping jaws for PU special profiles.**

Round belts

RS Clamping jaws round belt Ø 6,0 mm	FBWSBR060
RS Clamping jaws round belt Ø 6,3 mm	FBWSBR063
RS Clamping jaws round belt Ø 7,0 mm	FBWSBR070
RS Clamping jaws round belt Ø 7,9 mm	FBWSBR079
RS Clamping jaws round belt Ø 8,0 mm	FBWSBR080
RS Clamping jaws round belt Ø 9,0 mm	FBWSBR090
RS Clamping jaws round belt Ø 9,5 mm	FBWSBR095
RS Clamping jaws round belt Ø 10,0 mm	FBWSBR100
RS Clamping jaws round belt Ø 12,0 mm	FBWSBR120
RS Clamping jaws round belt Ø 12,5 mm	FBWSBR125
RS Clamping jaws round belt Ø 12,7 mm	FBWSBR127
RS Clamping jaws round belt Ø 13,0 mm	FBWSBR130
RS Clamping jaws round belt Ø 14,0 mm	FBWSBR140
RS Clamping jaws round belt Ø 14,3 mm	FBWSBR143
RS Clamping jaws round belt Ø 15,0 mm	FBWSBR150
RS Clamping jaws round belt Ø 15,9 mm	FBWSBR159
RS Clamping jaws round belt Ø 17,0 mm	FBWSBR170
RS Clamping jaws round belt Ø 18,0 mm	FBWSBR180
RS Clamping jaws round belt Ø 19,0 mm	FBWSBR190
RS Clamping jaws round belt Ø 20,0 mm	FBWSBR200



for round belts



for V-belts

V-belts

RS Clamping jaws V-belt (Y) 6 x 4 mm	FBWSBK06
RS Clamping jaws V-belt (M) 8 x 5 mm	FBWSBK08
RS Clamping jaws V-belt (Z) 10 x 6 mm	FBWSBK10
RS Clamping jaws V-belt (A) 13 x 8 mm	FBWSBK13
RS Clamping jaws V-belt (B) 17 x 11 mm	FBWSBK17
RS Clamping jaws V-belt (C) 22 x 14 mm	FBWSBK22

V-belts special versions

RS Clamping jaws V-belt 8 x 6,5 mm	FBWSBK8X65
RS Clamping jaws V-belt 10 x 8 mm	FBWSBK10X8
RS Clamping jaws SuperGrip (Z) 10 x 6 mm	FBWSBK10G
RS Clamping jaws SuperGrip (A) 13 x 8 mm	FBWSBK13G
RS Clamping jaws SuperGrip (B) 17 x 11 mm	FBWSBK17G
RS Clamping jaws SuperGrip (C) 22 x 14 mm	FBWSBK22G
RS Clamping jaws (B) 17 x 11 for brush 90°	FBWSBK17B
RS Clamping jaws (C) 22 x 14 for brush 90°	FBWSBK22B

Rigde top V-belts

RS Clamping jaws SK1 (B) 17 x 19 mm	FBWSBK17X19
RS Clamping jaws SK1 (C) 22 x 24 mm	FBWSBK22X24

Twin V-belts

RS Clamping jaws Twin V-belt 21 x 8 mm	FBWSBK21X8
RS Clamping jaws Twin V-belt (Z) 24 x 6,8 mm	FBWSBK24X68
RS Clamping jaws Twin V-belt 30 x 8 mm	FBWSBK30X8

T-Profiles

RS Clamping jaws T-Profile 15 x 5 mm	FBWSBST15X5
RS Clamping jaws T-Profile 5 x 5 x 25 mm	FBWSBST5525

Special profiles

RS Clamping jaws Square profile 11,8 x 11,8 mm	FBWSBSQ118
RS Clamping jaws U-Profile 18 x 11,8 mm	FBWSBSU180
RS Clamping jaws Prism V-belt 33 x 8 mm	FBWSBS33X8
RS Clamping jaws Peach profile 28 x 29 mm	FBWSBS28X29

FRICION WELDING TECHNOLOGY FOR PU

The unique friction welding machine RS02 is the professional tool for the maintenance operator and also the fastest and most reliable way of welding belt profiles. Constantly good quality connections are produced in a few seconds with repeatable accuracy due to fixed welding parameters.

Welding clamping jaws tuned to the respective profile ensure reliable clamping and perfect alignment of the profile.

Thanks to its handy type of construction, the friction welding machine can even be used in narrow space conditions for comfortable welding. The recently developed battery version is now available to ensure unlimited freedom of motion.

USE

Which profiles can be welded?

The RS02 friction welding machine can be used for butt welding of PU round belts with/without reinforcement from 6 to 20 mm and PU V-belts with/without reinforcement from 6 x 4 mm to 22 x 14 mm.

Still many other geometrical shapes and special profiles can be joined by means of special clamping jaws using this welding technology

How does friction welding work?

Basically this welding technology uses the reciprocal coefficients of friction of the profile materials and thus effect fusion of the material in the joint under pressure and in executing a rotational movement. It is up to the user to decide when the process can be terminated when a welding bead has been produced all over the joint.

What has to be observed to produce a proper weld?

Clamping jaws tuned to the respective geometry are required for reliable clamping of the profiles during this procedure.

Flat and angularly cut belt ends are an important prerequisite for this welding procedure to create optimum welding conditions and produce friction over the entire joint surface. For belt profiles with reinforcement it is required before welding, as usual, to drill out the reinforcement at the joint surfaces by some millimetres to prevent the reinforcement from crossing in the joint and consequently deterioration of the welded connection.

An exception is the patented weldable glass fibre reinforcement of BEHAbelt where this working step is unnecessary.



Tutorialvideo on YouTube

HIGHLIGHTS

- **Mobile use** thanks to small design.
- Welding parameters defined by the speed and pressure.
- **TOP welding quality** thanks to welding results with repeatable accuracy.
- **Machine is immediately ready for use; no heating time required.**
- **High process mastery** with excellent repeat accuracy.
- **Reduction of the risk of accidents,** as no hot parts are involved.





Paddle lengths

EERGO 60



EERGO 90

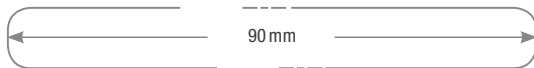

Scope of delivery:

- 1 pc. EERGO 60 oder 90
- 1 pc. Carrying bag

EERGO 60

Dimensions: 185 x 210 x 55 mm (HxWxD)
Weight: approx. 380 g, Power: 120 W

EERGO 90

Dimensions: 185 x 240 x 55 mm (HxWxD)
Weight: approx. 420 g, Power: 120 W

Description

EERGO 60, 230V/60 mm
EERGO 90, 230V/90 mm

Order No.

FBWEE001
FBWEE019

EERGO 60 & 90

The BEHAbelt EERGO paddle welding tools were specially developed for the connection of PU and TPE profiles or flat belt strips.

Features at a glance

- Strong, fiberglass-reinforced ergonomic housing.
- Unique control panel for one-handed operation.
- No adhesion of PU and TPE materials, thanks to Teflon-coated welding paddle.
- Easy cleaning with cloth.

Highlights



Heating-up time: approx. 5 minutes.



Innovative safety rest for safe placement on the work surface.



Ergonomic design for a natural working position.



Easy to use temperature selector regulates correct temperature to weld PU or TPE profiles.



Constant welding temperature at different ambient temperatures.



Spare parts

Spare paddle EERGO 60

Order No. **FBWEE002**
Dimensions (HxWxD): 43 x 65 x 6 mm



Spare paddle EERGO 90

Order No. **FBWEE025**
Dimensions (HxWxD): 43 x 95 x 6 mm



Tutorialvideo on YouTube

EERGO-Set „small“ 60

**Professional welding set for small profiles:
 Round belts up to 10mm and V-belts up to profile 10x6 (Z)**

- 1 pc. EErgo 60 paddle welding tool
- 2 pcs. Guide clamps FZ01
- 1 pc. Edge cutter SE02
- 1 pc. Scissors AS02 with stop
- 1 pc. Carrying bag small

EERGO-Set Vario „small“ 60

**Professional welding set for small profiles:
 Round belts up to 10mm and V-belts up to profile 10x6 (Z)**

- 1 pc. EErgo 60 paddle welding tool
- 1 pc. Guide clamp FZ01 Vario
- 1 pc. Edge cutter SE02
- 1 pc. Scissors AS02 with prism
- 1 pc. Carrying bag small



FZ01 Vario

EERGO-Set „universal“ 60

**Professional welding set for small and big profiles:
 round belts all sizes an V-belts up to profile 32 (D)**

- 1 pc. EErgo 60 paddle welding tool
- 2 pcs. Guide clamps FZ01
- 1 pc. Edge cutter SE02
- 1 pc. Scissors AS04 with stop
- 1 pc. Guide clamp FZ02/3
- 1 pc. Carrying bag big

EERGO-Set Vario „universal“ 60

**Professional welding set for small and big profiles:
 round belts all sizes an V-belts up to profile 32 (D)**

- 1 pc. EErgo 60 paddle welding tool
- 1 pc. Guide clamp FZ01 Vario
- 1 pc. Edge cutter SE02
- 1 pc. Guide clamp FZ02/3
- 1 pc. Scissors AS04 with stop
- 1 pc. Carrying bag big



FZ01 Vario



Description

EErgo-Set „small“ 230V / 60 mm
 EErgo-Set Vario „small“ 230V / 60 mm

Order No.

FBWEE003
 FBWEE011



Description

EErgo-Set „universal“ 230V / 60 mm
 EErgo-Set Vario „universal“ 230V / 60 mm

Order No.

FBWEE004
 FBWEE014



Polyurethane PU 290 °C
Polyester TPE 240 °C

**Continuously
temperature control**

Multi TC

BEHAbelt Multi TC is the proven continuously adjustable paddle welding tool for polyurethane and polyester.

Features at a glance

- Easy and safe handling.
- Very fast heating-up period.
- Variable temperature setting through adjusting wheel.
- Continuous welding temperature through temperature control even at long-term operation.
- LED display for signal of optimum welding temperature.
- Teflon coated welding paddle.
- Easy cleaning with cloth.

Scope of delivery:

1 pc. Multi TC welding tool
Temperature-controlled welding tool for two
temperature ranges: PU 290 °C / Polyester 240 °C

Dimensions: 295 x 35 x 25 mm (HxWxD)
Weight: approx. 250 g
Heating time: approx. 5 Min.
Temperature range: continuously 200...300 °C
Power: 75 W

Description
Multi TC 230 V

Order No.
FBWMTc230



Spare parts

Spare paddle Multi TC

Order No. **FBWMTc1**
Dimensions (HxWxD): 35 x 35 x 2 mm



Spare paddle Multi TC for flat belts

Order No. **FBWMTc2**
Dimensions (HxWxD): 25 x 70 x 2 mm



SG02 / SG03

The cost-effective welding technology.

SG02 for PU
SG03 for TPE

Features at a glance

- Easy and safe operation.
- Fixed, unregulated temperature setting.
- Reaches the welding temperature after approx. 10 min.
- Small, convenient and tough welding tool.
- No adhesion of PU and TPE materials, thanks to Teflon-coated welding paddle.
- Easy to clean with a cotton cloth.

Caution! Not suitable for continuous use.



Scope of delivery:

1 pc. SG02 welding tool
for Polyurethane (PU) 280 - 290 °C

or

1 pc. SG03 welding tool
for Polyester (TPE) 225 - 240 °C

Dimensions: 280 x 33 x 33 mm (HxWxD)

Weight: approx. 227 g

Heating time: approx. 10 Min.

Power: 80W (SG02); 40W (SG03)

Description

SG02 PU – 230 V

SG03 TPE – 230 V

Order No.

FBWSG02

FBWSG03

Spare parts

Spare paddle SG02 or SG03

Order No. **FBWTC72**

Dimensions (HxWxD): 35 x 35 x 2 mm



Spare paddle SG02 or SG03 for flat profiles

Order No. **FBWTC76**

Dimensions (HxWxD): 22,5 x 75 x 2 mm



Guiding clamps



For 90° welding

Dimensions (HxWxD):
205 x 90 x 100 mm
Weight: approx. 617 g



Example for special profile
adapter insert

Description

Guiding clamp FZ02/3
incl. Standard adapter insert
Adapter insert for special profiles

Order No.

FBWFZ02/3
FBWFZ020T00



Tutorialvideo on YouTube

FZ02/3

Guiding clamp FZ02/3 Standard

Robust and accurate for V-belts up to profile 32 (D)
and round belts from \varnothing 8 mm.

Adapter inserts for special profiles

Existing Geometries in mm: 12,5x5, 15x5, 16x8, 18x6,
24x6,8, 25x5, 30x8, 38x2, 6x4x9, 21x8, 28x10, flat profiles,
square profiles, U-profiles, T-Profiles 10x6, 28x10.
Other geometries on request.



Recommended for use with EErgo 60



For 90° welding

Dimensions: 205 x 90 x 100 mm (HxWxD)
Weight: approx. 617 g

Description

Guiding clamp FZ02/3F
Adapter insert for special profiles

Order No.

FBWFZ02/3F
FBWFZ020T00



Tutorialvideo on YouTube

FZ02/3F

Guiding clamp FZ02/3F for flat belts

Robust and accurate for flat profiles.
Width max. 80 mm and Height 1,6 - 5 mm.



Recommended for use with EErgo 90

FZ01 Vario

Guiding clamp FZ01 Vario metal can be assembled in two operating modes. With and without handle!

Convenient and tough for round belts up to \varnothing 10 mm and V-belts up to profile 10 (Z).
 Exchangeable profile jaws allow custom profiles to be spliced easily.

Highlights

- Fast, reliable and exceptionally precise connecting of PU and TPE profiles.
- Special inserts for: PJ2, PJ3 and PJ4 ribbed V-belts.
- Your choice for standard and customized profiles!

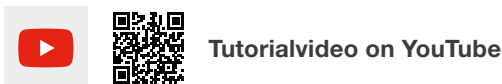

Quick clamp device for inserting the profiles in exchangeable profile jaws.



Automatic unlocking starts off lateral pressure.



Precise welding thanks to constant pressure.

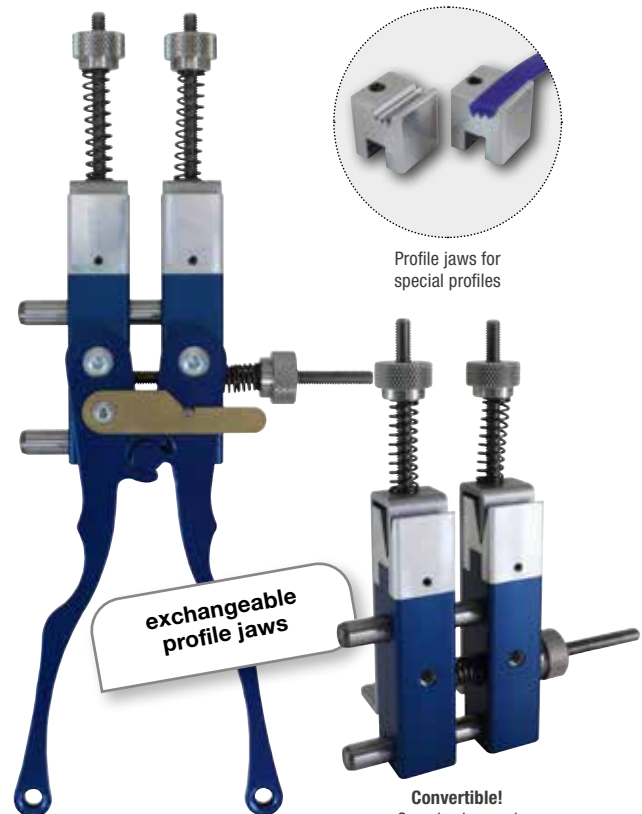

Profile jaws for special profiles

exchangeable profile jaws

Convertible!
 Can also be used without handle.

Dimensions: 240 x 125 x 50 mm
 140 x 195 x 50 mm without handle
 Weight: approx. 365 g
 approx. 320 g without handle

Description
 FZ01 Vario
 Profile jaws PJ2/PJ3/PJ4
 Profile jaws T-Profile 10x4,5
 Profile jaws T-Profile 9,5x3,5

Order No.
FBWFZ01V
FBWPBJ2-4
FBWPBT10x45
FBWPBT95x35

FZ01

Handy and lightweight guiding clamp for round belts up to \varnothing 10 mm and V-belts up to profile 10 (Z).

Highlights

- Fast, reliable and exceptionally precise connecting of PU and TPE profiles.
- Your choice for standard profiles!



Dimensions: 127 x 70 x 35 mm
 Weight: approx. 140 g

Description
 Guiding clamp FZ01

Order No.
FBWFZ01



Heating plate dimensions: 120 x 60 mm

Scope of delivery:

1 pc. Hot press HP01 AIR, 1 pc. PPuls Controller Element,
1 pc. Edge cutter SE02, 1 pc. Screw driver,
1 pc. Scissors AS04, 1 pc. Aluminium case

Dimensions (HxWxD): 240 x 167 x 200 mm

Weight: approx. 4800 g

Description

Standard Set HP01 /Air cooling, 230V

Order No.

FBWHP011L230

HP01 AIR

HP01 AIR is the air-cooled version of the hot press and offers mobility thanks to its compact design.

Features at a glance

- Very easy to use.
- Reduces operator errors through a fully automatic and controlled welding and vulcanization process.
- Thanks to its exchangeable moulds the HP01 is suitable for splicing many different profiles and flat belts made of PU and TPE as well as timing belts.
- User friendly operation through self-explanatory menu of controller (no expertise required).
- Perfect welding within minutes.
- Temperature variation is never a concern (no guesswork).
- Real time data logging & diagnostics function for quality assurance of the splice.
- Different types of welds possible (overlap welds, butt welds and angle welds).
- Due to its small size and the hook for hanging up the press during the welding process, the HP01 can be used in confined spaces "on-site".
- Best welding solution for reinforced profiles (aramid, polyester and steel) through overlap welding.



Tutorialvideo on YouTube

HP01 WATER

HP01 WATER is the water cooled version of the hot press and offers higher cooling capacity.

Features at a glance

Same characteristics as HP01 AIR, but with the following distinguishing features:

- Higher cooling capacity
- Cooling drum included in scope of supply
- Could also be cooled with compressed air



Description

Standard Set HP01/water cooling, 230 V

Order No.

FBWHP011W230

Scope of delivery:

1 pc. hot press HP01 WATER, 1 pc. Cooling unit 6,4 l with pump, 1 pc. PPuls Controller Element,
1 pc. Edge cutter SE02, 1 pc. Screw driver,
1 pc. Scissors AS04, 1 Set Connecting hoses,
1 pc. Aluminium case



Shaft for HP01 to use with torque wrench available as accessory

FBWHPSD12

Standard moulds for HP01 Hotpress

Moulds for PU and TPE round- and V-belts.
Other dimensions on request.

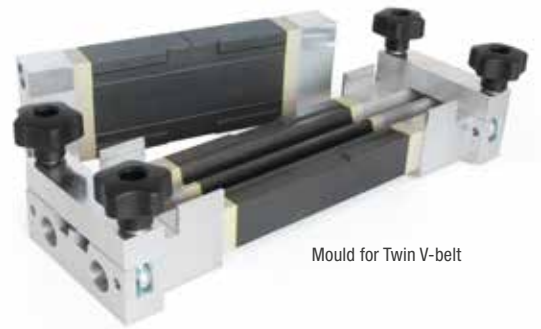

Mould for Twin V-belt

Round belts

Mould Ø 6,0 mm	FBWFS060
Mould Ø 6,3 mm	FBWFS063
Mould Ø 7,0 mm	FBWFS070
Mould Ø 8,0 mm	FBWFS080
Mould Ø 9,5 mm	FBWFS095
Mould Ø 10,0 mm	FBWFS100
Mould Ø 12,0 mm	FBWFS120
Mould Ø 12,5 mm	FBWFS125
Mould Ø 14,3 mm	FBWFS143
Mould Ø 15,0 mm	FBWFS150
Mould Ø 18,0 mm	FBWFS180
Mould Ø 20,0 mm	FBWFS200

V-belts

Mould (Z) 10x6 mm	FBWFS100X060
Mould (A) 13x8 mm	FBWFS130X080
Mould (B) 17x11 mm	FBWFS170X110
Mould (C) 22x14 mm	FBWFS220X140

V-belt special version

Mould 8x6,5 mm vaulted top	FBWFS080X065
Mould 10x8 mm	FBWFS100X080
Mould 16,35x11,3 mm (bluepower)	FBWFS163X113
Mould 17x11,3 mm (bluepower)	FBWFS170X113

Timing belts (width max. 50 mm)

Mould for timing belt HTD5	FBWFZHTD5MN
Mould for timing belt HTD8	FBWFZHTD8MN
Mould for timing belt T5	FBWFZT5N
Mould for timing belt T10	FBWFZT10N
Mould for timing belt AT5	FBWFZAT5N
Mould for timing belt AT10	FBWFZAT10N
Mould for timing belt AT20	FBWFZAT20N
Mould for timing belt H (B: 50,8 mm/2")	FBWFZH0
Mould for timing belt L (B: 50,8 mm/2")	FBWFZL0
Mould for timing belt RPP 8M	FBWFZRPP8MN



Mould for timing belt

Belt edge special version

Mould 14x28 mm	FBWFS14X28
----------------	------------

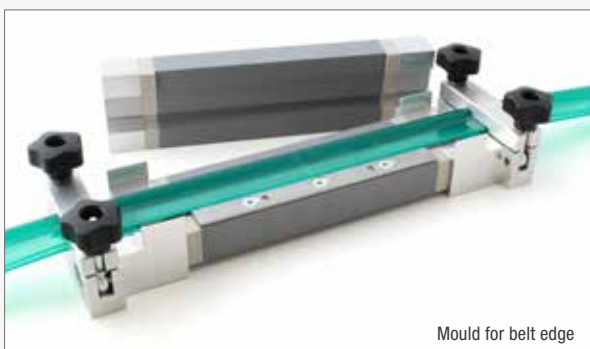

Mould for belt edge



We would be happy to check the realisation for your belt edge profile.

Belt edge profiles can be found on page 83.





SH01

Designed to accurately cut and prepare reinforced profiles for overlap welding with the BEHAbelt HP01 hot press.

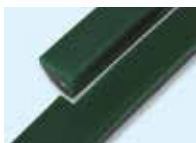

Before overlap welding

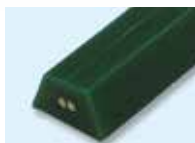

After overlap welding

Scope of delivery

- 1 pc. Belt cutter SH01
- 1 pc. Screwdriver
- 1 pc. Profile adapter at your choice
- 1 pc. End wrench
- 1 set Washers

Adapters available for the following profiles:

- Round belts \varnothing 6,0 - 20,0 mm
- V-belts 13 x 8 (A), 17 x 11 (B), 22 x 14 (C), bluepower

Dimensions (HxWxD): 200 x 80 x 45 mm

Weight: approx. 1,3 kg

Description

Belt cutter SH01
with 1 profile adapter at your choice

Order No.

FBWSH1

Profile adapters for round belts

Order No.	Description	Dimensions (mm)
FBWSH1R060	Profile adapter for round belts	\varnothing 6,0
FBWSH1R063	Profile adapter for round belts	\varnothing 6,3
FBWSH1R080	Profile adapter for round belts	\varnothing 8,0
FBWSH1R095	Profile adapter for round belts	\varnothing 9,5
FBWSH1R100	Profile adapter for round belts	\varnothing 10,0
FBWSH1R120	Profile adapter for round belts	\varnothing 12,0
FBWSH1R125	Profile adapter for round belts	\varnothing 12,5
FBWSH1R150	Profile adapter for round belts	\varnothing 15,0
FBWSH1R180	Profile adapter for round belts	\varnothing 18,0
FBWSH1R200	Profile adapter for round belts	\varnothing 20,0

Formnester für Keilriemen

Order No.	Description	Dimensions (mm)
FBWSH1K10	Profile adapter for V-belts	10 x 6 (Z)
FBWSH1K13	Profile adapter for V-belts	13 x 8 (A)
FBWSH1K17BP	Profile adapter for V-belts bluepower	17 x 11,3
FBWSH1K17	Profile adapter for V-belts	17 x 11 (B)
FBWSH1K22	Profile adapter for V-belts	22 x 14 (C)
	Profile adapters for special profiles on request	



Profile adapter for round belts



Profile adapter for V-belts

Joining Set CRIMP* - for steel reinforced profiles

The new and improved CRIMP connection supports you to achieve perfect results when connecting belts with steel reinforcement.



Canning industry: Crimp Connection

A special design is the connection of belts with steel reinforcement. Here, the exposed reinforcement is connected with press sleeves and the resulting gap in the connection point is then filled again with material inserts/welding sleeves. Using a profile mould and a hot press, the splice zone is then filled up and welded by pressure and temperature to the rest of the belt.

Our RH-2 joining set is available for this purpose and provides you with the complete equipment and material for creating such a splice.



Tutorialvideo on YouTube



1
Join exposed reinforcement
with press sleeves



2
Fill the gap with
material inserts



3
Positioning of the unwelded
splice into the mould

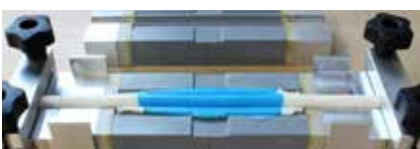

4
Profile joined by
hot press



Carrying bag



CU crimps



Inner outer welding sleeves



Cable stripper cutter
for can cable



Stripping hook for can cable



Crimping tool RH-2

Scope of delivery CRIMP-Set RH-2

- 1 pc. Carrying bag
- 1 pc. Crimping tool RH-2
- 1 pc. Cable stripper
- 1 pc. Stripping hook
- 3m respectively polyester sleeves (outside/inside)
- 100 pcs. CU crimps

Description

- Crimp-Set RH-2 \varnothing 9,5 mm
- Crimp-Set RH-2 \varnothing 10 mm
- Crimp-Set RH-2 \varnothing 12 mm
- Crimp-Set RH-2 \varnothing 12,5 mm

- Order No.**
FBWRH2SET095
FBWRH2SET100
FBWRH2SET120
FBWRH2SET125

* Ferrules

GENERAL

This welding technology provides perfect process control with the BEHbelt HP01 hot press especially developed for belt profiles and the associated PPuls Element temperature control for sophisticated industrial production of a welded connection.

Thanks to the small design and a number of smart design details this hot press is perfectly suitable for on-site use and in confined spaces. The unit can be made upon request of the customer as a water or air cooled version.

HP01 is the best choice for the best welding results in particular for the production of overlap welds of belt profiles.

USE

Overlap joints

HP01 is particularly well suited for the production of butt and overlap welds for round and V-belts with a diameter from 6 to 20 mm and for V-belts from 6x4 to 22x14 mm. A suitable mould is used to press the splice under temperature and pressure influence thus producing a firm connection.

For overlap welding, a preparatory work step is required to prepare the welding point by cutting the belt to size. For this purpose the special cutting aid SH01 has been developed which ensures precise preparation for welding in repeatable accuracy. The overlap weld thus achieves the strength of approx. 50% of the reinforcement used. Overlap welding always results in a stiff welding area and therefore it is required to consider this fact when selecting the minimum pulley diameter.

Timing belts and flat belts

Hot press HP01 also offers a further additional benefit with regard to the option of welding timing belts and flat belts up to the max. width of 50 mm in using appropriate moulds. The respective mould delivery program is available. Punching technology for preparation of the connection is not available.

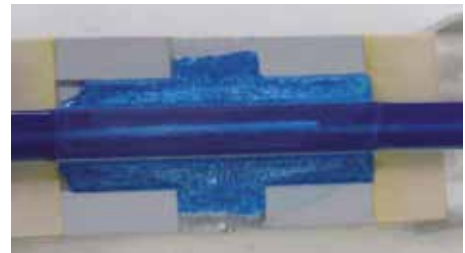
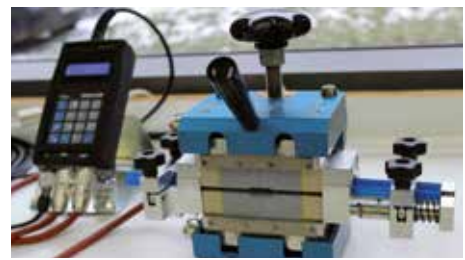

Tutorialvideo on YouTube



Moulds also available for flat belts and timing belts!

FZ03/1 & EErgo Z

Overlap welding set consisting of guide unit and EErgo Z

Product features FZ03/1

- Professional and easy to use guide clamps for overlap welding of reinforced profiles.
- Completely tool-free adjustment of the welding position for welding with Z-paddle.
- Uniform contact pressure over the entire welding surface of the profile for perfect welding quality
- Application range for round belts from 6-20mm and for V-belts from 8x5mm to 32x20mm.
- Safe handling with high repeat accuracy of the welding position thanks to toggle lever.
- Scope of delivery includes assembly option with table mounting and vice.
- Unique contact pressure in radial and axial alignment!

Product features EErgo-Z

- Robust, fibreglass-reinforced and ergonomic handle.
- Special Z-paddle for overlap welding with guide clamp FZ03/1.
- Correct temperature setting thanks to predefined buttons per welding material (PU 280 °C / Polyester 240 °C).
- Precise and stable temperature control for avoidance of temperature fluctuations under different welding conditions
- No adhesion of PU and TPE material thanks to Teflon-coated welding paddle
- Matching magnetic storage stand for safe storage of the welding paddle even when welding in the system

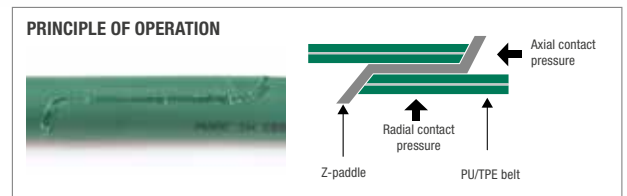

Compact guide unit for overlap welding by means of Z-paddle with vertical and horizontal contact pressure



Hot paddle welding tool EErgo with Z-paddle

Spare parts

Spare paddle EERGO-Z

Order No. **FBWEE024**

Dimensions (WxDxH):
approx. 100 x 65 x 6 mm



Scope of delivery:

1 pc. Set FZ03/1 (consisting of: FZ03/1, EErgo Z, Storage stand with magnetic base, AS04, SE02, 1 set of Clamping pieces of your choice, table mounting, Carrying case, Instruction manual)

Description

FZ03/1 Set
8,0 kg, approx. 550 x 210 x 350 mm (WxDxH)

Order No.

FBWFZ03/1A

EErgo-Z
450 g, approx. 210 x 210 x 55 mm (WxDxH)
Power: 240 W

FBWEE026

FZ03/1 Guide Unit
3,3 kg, approx. 210 x 250 x 70 mm (WxDxH)

MBWFZ03/1A

Overlap welding set with EErgo-Z

Clamping pieces for FZ03/1

1 set of clamping pieces consists of 2 parts

Features at a glance

- Please note each belt profile requires a matching set of clamping pieces.
- Therefore, please select the appropriate clamping pieces for the required profile geometry.
- **On request, we also manufacture clamping pieces for PU special profiles.**

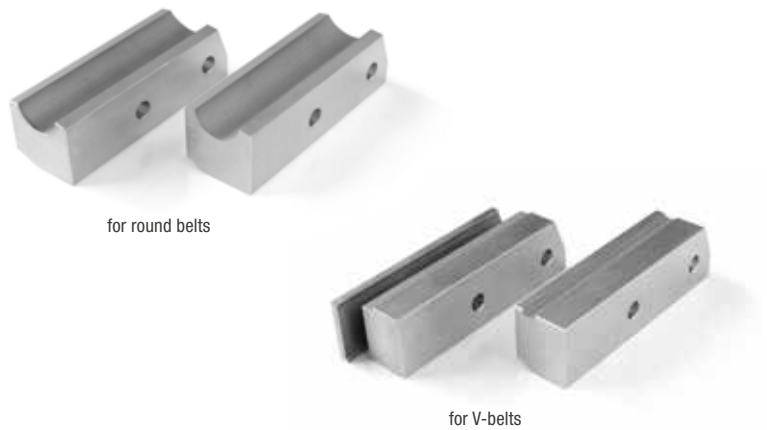

Round belts

Clamping piece for FZ03/1 Ø 6,0 mm	FBWKS1R060
Clamping piece for FZ03/1 Ø 6,3 mm	FBWKS1R063
Clamping piece for FZ03/1 Ø 7,0 mm	FBWKS1R070
Clamping piece for FZ03/1 Ø 7,9 mm	FBWKS1R079
Clamping piece for FZ03/1 Ø 8,0 mm	FBWKS1R080
Clamping piece for FZ03/1 Ø 9,5 mm	FBWKS1R095
Clamping piece for FZ03/1 Ø 10,0 mm	FBWKS1R100
Clamping piece for FZ03/1 Ø 12,0 mm	FBWKS1R120
Clamping piece for FZ03/1 Ø 12,5 mm	FBWKS1R125
Clamping piece for FZ03/1 Ø 12,7 mm	FBWKS1R127
Clamping piece for FZ03/1 Ø 13,0 mm	FBWKS1R130
Clamping piece for FZ03/1 Ø 14,0 mm	FBWKS1R140
Clamping piece for FZ03/1 Ø 14,3 mm	FBWKS1R143
Clamping piece for FZ03/1 Ø 15,0 mm	FBWKS1R150
Clamping piece for FZ03/1 Ø 15,9 mm	FBWKS1R159
Clamping piece for FZ03/1 Ø 17,0 mm	FBWKS1R170
Clamping piece for FZ03/1 Ø 18,0 mm	FBWKS1R180
Clamping piece for FZ03/1 Ø 19,0 mm	FBWKS1R190
Clamping piece for FZ03/1 Ø 20,0 mm	FBWKS1R200

V-belts

Clamping piece for FZ03/1 (M) 8x5 mm	FBWKS1K8
Clamping piece for FZ03/1 (Z) 10x6 mm	FBWKS1K10
Clamping piece for FZ03/1 (A) 13x8 mm	FBWKS1K13
Clamping piece for FZ03/1 (B) 17x11 mm	FBWKS1K17
Clamping piece for FZ03/1 (C) 22x14 mm	FBWKS1K22
Clamping piece for FZ03/1 (D) 32x20 mm	FBWKS1K32



In the upper part of the transport bag there is a generally usable space for the side cutter SE02 and free compartments for 9 optional clamping piece pairs.



Robust transport case for the overlap welding set FZ03/1.

HS400 & 800

Specially developed hot paddles for butt welding of conveyor belts. The design of the welding device allows easy and professional handling.

Product features

- HS400 for up to 400 mm belt width
- HS800 for up to 800 mm belt width
- Sophisticated design with positioning aids and stoppers ensures highly repeatable accuracy of weldings
- Clamping lever with locking device
- Robust and handy design of the individual components
- Exact temperature adjustment via control unit
- No adhesion of PU or TPE material due to Teflon-coated heating paddle
- Easy cleaning of the heating blade with a cotton cloth
- Reduced risk of injury during cutting due to practical cutting device
- Welding unit delivered in a mobile, stable transport box for easy use on site
- Smallest weldable belt length $L_f = 800$ mm



HS400S / HS800S

Special design for short belt lengths from $L_f = 500$ mm



Scope of delivery:

- 1 pc. HS 400-Set (consisting of HS-BOX, HS400, FT400, Bead remover, insert-bar and transport case 400)
- 1 pc. HS 800-Set (consisting of HS-BOX, HS800, FT800, Bead remover, insert-bar and transport case 800)

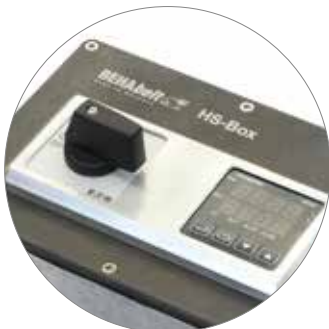

Robust and easy to use control unit for temperature control



Insert bar for repeatable welds



Clamping bars with chamfer for optimum shaping of the welding bead



Easy removal of the welding bead with the supplied tool

Description

HS400 Welding set in case
35,0 kg, approx. 50 x 95 x 30 cm (BxLxH)

HS800 Welding set in case
48,0 kg, approx. 50 x 135 x 30 cm (BxLxH)

Order No.
FBWHS400

FBWHS800

Individual components:

HS BOX (Control unit for HS400/800)
1,2 kg, approx. 18 x 20 x 15 cm (WxLxH)
Power: max. 3,2 kW / 230V AC

FBWHSB01

HS400 (Heating paddle 400mm)
1,2 kg, approx. 8 x 60 x 17 cm (WxLxH)
Power: 2,3 kW / 230 V AC

FBWHS400S01

HS800 (Heating paddle 800mm)
1,7kg, approx. 8 x 100 x 17 cm (WxLxH)
Power: 3,2 kW / 230 V AC

FBWHS800S01

HS400S (Heating paddle 400mm)
1,2 kg, approx. 8 x 60 x 17 cm (WxLxH)
Power: 2,3 kW / 230 V AC

FBWHS400S02

HS800S (Heating paddle 800mm)
1,7kg, approx. 8 x 100 x 17 cm (WxLxH)
Power: 3,2 kW / 230 V AC

FBWHS800S02

FT400 (Joining table for HS400)
12,5 kg, approx. 28 x 55 x 20 cm (WxLxH)

FBWHS400FT01

FT800 (Joining table for HS800)
20,0 kg, approx. 28 x 95 x 20 cm (WxLxH)

FBWHS800FT01



WELDING TECHNOLOGY FOR ELASTIC MONOLITHIC BELTS

Elastic monolithic PU conveyor belts from BEHAbelt offer new fabrication possibilities. Due to the lack of traction layers joining by finger welding is no longer necessary, as the monolithic belt has a homogeneous design – even in the weld seam.

The welding device HS from BEHAbelt is a simple, handy, reliable and cost-effective tool for butt joining of monolithic belts. Depending on customer requirements, two versions are available with the joining table and heating paddle for max. belt widths up to 400 and up to 800 mm.

The simple operation in combination with the intuitive production aids enables a repeatable and high-quality connection of the belts.

Optional adapter plates ensure precise positioning and clamping of the butt ends to be welded.



Compact and mobile: the practical HS welding tool for monolithic conveyor belts

Angle to straight (90°) and bias (70°) cutting of the belts directly in the welding unit (included in the scope of delivery).

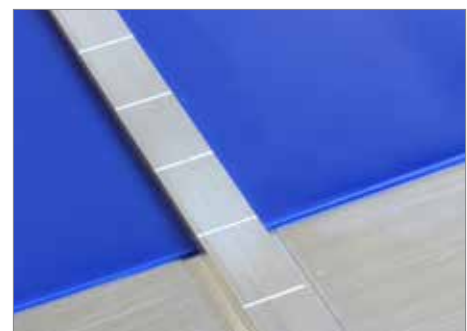

Precise and aligned insertion of the belt ends.



Tutorialvideo on YouTube



Robust aluminium bars support (70° and 90°) the precise insertion of the belt ends and ensures a high repeat accuracy (included in the standard scope of delivery).

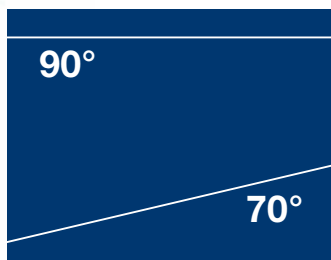

Straight weld with 90° and angled joint with 70° (e.g. for check weighers)



For optimum alignment and clamping of the belts to be welded in the joining table, optional adapter plates for more complex structures are available (not included in the standard product range).

Adapter plates for HS400 & 800

Adapter plates Spike (HS400)	FBWHS4APSP
Adapter plates Spike (HS800)	FBWHS8APSP
Adapter plates AT5 (HS400)	FBWHS4APT5
Adapter plates AT5 (HS800)	FBWHS8APT5



Locking pins ensure the correct positioning of the adapter plates on the joining table.



RS02 Adapter

Clamping jaw adapter aluminium for friction welding machines RS02 and RS02 CORDLESS

Description
RS02-Adapter Alu

Order No.
FBWAPRS02A



O-Rings for RS02-Adapter & clamping jaws

O-rings for fixing the clamping jaws and adapters in RS02 and RS02 CORDLESS

black, rubber, suitable for all RS clamping jaws and adapters

Description
O-Rings for clamping jaws (10 pcs.)

Order No.
MNORING01



Assortment box

Assortment box for clamping jaws for RS02 / RS02 CORDLESS

with 9 pockets, transparent Box

Description
Assortment box

Order No.
FBWSORT9



Hexagon wrench

for RSX01 Mandrel Welder

For loosening the clamping jaws on the RSX01 Mandrel Welder. Plug-in dimension 7 mm

Bezeichnung
Hexagon wrench

Best.-Nr.
FBWSW7X125



Hexagon torque wrench

RS Hexagon torque wrench 7 / 5 Nm

Description
Hexagon torque wrench

Order No.
FBWSW7/5NM



Protective cap for clamping lever RS02

For external thread of clamping lever on RS02 and RS02 CORDLESS

Description
Protective cap for clamping lever

Order No.
MFKKB01



Battery for RS02 CORDLESS

Spare battery for friction welding machine RS02 CORDLESS 18V / 4Ah (72Wh)

Description
RS02 Battery

Order No.
FBWRS02AK18V



Charging unit for RS02 CORDLESS

Charging unit 4A / 230V for RS02 CORDLESS

Description
LG4A Charging unit

Order No.
FBWRS02LG4A2



EM01 Deburring knife set and spare blades

Knife for removing the welding bead from conveyor belts incl. various replacement blades

Description	Order No.
Deburring knife Set	FBWEM001
Spare blades (10 pcs.)	FBWEM001B12
B 12 mm	



SH01 Spare blade

Spare blade for belt cutter SH01

Description	Order No.
SH01 spare blade	MBREKSH01



AS02

Scissors small with stop

90° cut for round belts up to Ø 12 mm.

Description	Order No.
AS02	FBWAS02



AS03

Scissors big with stop

For 90° cut and angle cut.

Description	Order No.
AS03	FBWAS03



AS04

Scissors big with angular stop (movable)

Scissors with movable angular stop
For 45°, 60°, 75°, 90°, 105°, 120° and 135° cuts.

Description	Order No.
AS04	FBWAS04



SE02

Edge cutter with special blade

to remove the welding bead accurately.

Description	Order No.
SE02	FBWSE02



SZ01

Pliers for fitting connectors

Description	Order No.
SZ01	FBWSZ01



Ratched cutter

For cutting very hard plastics e.g. PP, Nylon (PA), TPX, TPEE

Description	Order No.
Mandrel Scissors	FBWRCM01



Paddle (MultiTC)

Spare paddle for welding tool „MultiTC“

Dimensions (HxWxD):
35 x 35 x 2 mm

Description **Order No.**
Spare paddle MultiTC **FBWMTC1**



Paddle (MultiTC)

Spare paddle for flat profiles for welding tool „MultiTC“

Dimensions (HxWxD):
25 x 70 x 2 mm

Description **Order No.**
Spare paddle MultiTC **FBWMTC2**



Paddle (SG02/03)

Spare paddle for welding tools „SG02/03“

Dimensions (HxWxD):
35 x 35 x 2 mm

Description **Order No.**
Spare paddle SG02/03 **FBWTC72**



Paddle (SG02/03)

Spare paddle for flat profiles for welding tools „SG02/03“

Dimensions (HxWxD):
22,5 x 75 x 2 mm

Description **Order No.**
Spare paddle SG02/03 **FBWTC76**



Paddle (EErgo 60)

Spare paddle for welding tool „EErgo 60“

Dimensions (HxWxD):
43 x 60 x 6 mm

Description **Order No.**
Spare paddle EErgo 60 **FBWEE02**



Paddle (EErgo 90)

Spare paddles for flat profiles for welding tool „EErgo 90“

Dimensions (HxWxD):
43 x 90 x 6 mm

Description **Order No.**
Spare paddle EErgo 90 **FBWEE025**



Paddle EErgo-Z

Spare paddle Z for paddle welding tool „EErgo“

Dimensions (WxDxH):
approx. 100 x 65 x 6 mm

Description **Order No.**
Spare paddle EErgo-Z **FBWEE024**



EErgo protection kit

Combustion protection for stationary operation

Consisting of holder and metal housing

Description **Order No.**
EErgo Metal housing **FBWEEZ001**
EErgo Holder **FBWEEZ002**



KS75

Bench vise with ball joint for paddle welding tools

Fix your welding tool to facilitate stationary joining of the belt profiles easier.

Description **Order No.**
KS75 **FBWKS75**



Storage Stand

Storage stand with magnetic base for placing of EErgo welding tool

Note: EErgo not included in scope of delivery

Description **Order No.**
Storage stand with magnetic base **FBWEEZ003**



Carrying bags

„M“: 28 x 29 x 5 mm
„XL“: 30 x 24 x 11 mm

Description	Order No.
Carrying bag „M“	FCT000000002
Carrying bag „XL“	FCT000000003



Stripping hook for can cable

For processing the CRIMP connection; for pulling off the profile around the steel tension member

Description	Order No.
Stripping hook	FBWAH01



Cable stripper cutter for can cable

90° cut for round belts with steel reinforcement up to \varnothing 12 mm.

Description	Order No.
Cable stripper	FBWAW01



Cutting adapter HS

For cutting the belts directly in the HS400/800 welding unit. For 70° and 90° butt welding.

Description	Order No.
Cutting adapter	FBWHSSA01



Special heating paddle HS400S/800S

Special design for welding belt lengths from Lf = 500mm

Description	Order No.
HS400S Heating paddle	FBWHS400S02
HS800S Heating paddle	FBWHS800S02



FZ01 knurled nut

Plastic or metal replacement nut (M5)

Description	Order No.
FZ01 nut plastic	MDFZ01001
FZ01 nut metal	MDFZ01002

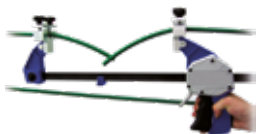

RSH01 & RSH02

Belt tensioner for tensioning of round and V-belts

RSH01 450 mm (18") tensioning distance, suitable to >1m belt length.

RSH02 900 mm (35") tensioning distance, suitable to >2m belt length.

Description	Order No.
RSH01 (450mm)	FBWRSH01
RSH02 (900mm)	FBWRSH02

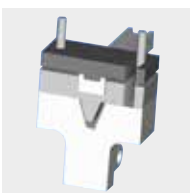

JOINING TOOLS FOR MANDRELS IN HOSE MANUFACTURING

BEHA Mandrel Welders are specially developed for welding mandrels made of PP, nylon (PA), TPEE and TPX. They are characterised by fast and error-free operation as well as simple and ergonomic handling.

More informationen: www.mandrel-welder.com



RSX01

With the RSX01 Mandrel welder, mandrels can be welded quickly and precisely. The welding parameters are optimally matched to the common materials, so that a high repetition accuracy is guaranteed with the simplest operation. As the splice is made by means of frictional heat, no long heating times are necessary.

Features

- Very quick connection of the hose mandrel ends by friction welding
- No danger of burns or fire
- Process reliability due to optimised welding parameters and exchangeable clamping jaws
- Can be used as manual or stationary solution
- Perfect weld joints



EErgo Mandrel

Practical and handy hot paddle welder with predefined temperatures for splicing mandrels made of PP, nylon, TPEE and TPX. The heating time is only 5 minutes and remains constant even with a wide range of ambient temperatures.

Features

- Fiberglass-reinforced ergonomic housing
- Easy operation: 1 Button for PP, 1 Button for Nylon, TPEE and TPX
- Alignment of mandrel ends with a guide clamp
- Ergonomic, user-friendly Design



LubeSite® automatic refill lubricators

Light construction



LubeSite® Series 200

LubeSite® 202, 205 and 260 within the clear-sight cages are the standard lubricators for most bearing applications.

They only supply lube oil, when the bearing is moving and therefore protect the bearing from over and under lubrication.

Units are assembled with medium sized springs. Three additional light and heavy springs are each included in a box of ten. Model 260 is delivered in a single package with additional springs (light, heavy).

Area of operation: -25...+120° C

Heavy construction



LubeSite® Series 300

LubeSite® 302, 305 und 360 are designed for bearing housings which operate under static conditions, vibration and centrifugal forces. The strong metal castings compensate for the heavy loads.

The main application areas are eccentric presses, compactors, stone mills, construction machines, pumps, etc.

Units are delivered with medium sized springs. Three additional light and heavy springs are each included in a box of ten. Model 360 is delivered in a single package with additional springs (light, heavy).

Area of operation: -25...+120° C

For chemically aggressive media



LubeSite® Series 500

LubeSite® 502, 505 and 560 is resistant to aggressive chemical agents. The light metal cases are made of special nickel-chrome double platen. The seals are plated with chemical resistant VITON.

The 500 series is a tried and tested product for many years in the chemical, food and nuclear industry.

Units are constructed with medium springs. Three additional light and heavy springs each are included in a box of ten.

Model 560 is delivered in a single package with additional springs (light, heavy)

Area of operation: -25...+120° C

For high temperatures



LubeSite® 704

LubeSite® 704 is the only automatic lubricator on the market, that can be used in ambient and high temperature applications. The case is made of light metal, the body is made of borosilicate glass, the pressure spring is made of high quality steel and the sealing is made of temperature consistent VITON.

LubeSite® 704 is used with best results within roller mills, plants, dehumidifiers, etc. Model 704 is delivered in a single package with one additional heavy spring.

Area of operation: -25...+230° C

Adapter



possible applications

- Automotive industry
- Transport and aviation
- Car wash plant
- Fertiliser production
- Food industry
- Dairy production
- Printing plants
- Ceramic industry
- Paper manufactures
- Textile industry
- Wood industry
- Tobacco production
- Beverage production
- Mining industry
- Oil production



Typ	low	medium	strong	extra strong
	Spring resilience N tensioned/unstressed			
202	26/13 N	40/20 N	54/27 N	98/49 N
205	30/15 N	44/22 N	72/36 N	90/45 N
260	84/42 N	130/65 N	140/70 N	156/78 N
302	26/13 N	40/20 N	54/27 N	98/49 N
305	30/15 N	44/22 N	72/36 N	90/45 N
360	84/42 N	130/65 N	140/70 N	156/78 N
302	26/13 N	40/20 N	54/27 N	98/49 N
305	30/15 N	44/22 N	72/36 N	90/45 N
360	84/42 N	130/65 N	140/70 N	156/78 N
704	–	80/40 N	158/79 N	–

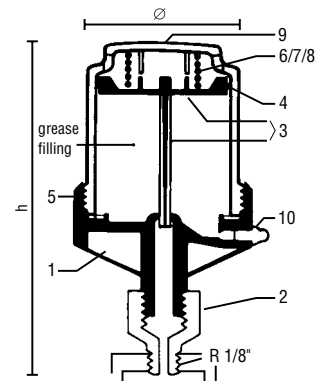

- 1 Body
- 2 screwed plug
- 3 Plunger and rod
- 4 O-Ring
- 5 Plunger and rod
- 6 Low spring
- 7 Medium spring
- 8 Strong spring
- 9 Clear case
- 10 Grease fitting